

Hooked on service





Aiming for the future!

Dear valued customers,

For more than 30 years, the Ben-Mor team has been proudly working by your side. Thanks to you, our passion is still as strong as it was on day one and continues to fuel our success. Thank you!

Our experienced team continues to grow both in talent and in knowledge, allowing us to expand our product and service offering to better meet your expectations and industry requirements. Innovation remains an important part of our purpose. For that reason, we are proud to present our new line of high-performance cables.

Ben-Mor's service territory continues to expand throughout North America. Over 375 employees in 11 plants contribute to the company's influence and growth, and maintain its position as a leader in the cable assemblies and lifting industry.

With an eye clearly focused on the future, and in the keeping with the spirit of our company, we continue to progress with audacity and energy in order to continue to offer you the best possible services and products. This is made possible by the best multidisciplinary team in the industry. Furthermore, in order to ensure the company's sustainability, we have secured the succession of our directors and management team for a successful future.

Thank you for your continued trust and support over all these years!



Left to right :

Louis Tétreault, VP Retail Sales and Supply Chain,

Richard Plante, Executive Vice-President,

Benoît Frappier, President and CEO of Ben-Mor,

Éric Rompré, Operation Vice-President,

Mélanie Frappier, VP Industrial Sales and Business Development

Hooked on SERVICE

SEATTLE

EDMONTON

Calgary

Saskatoon

Winnipeg



Calgary, Alberta



Saskatoon, Saskatchewan



Winnipeg, Manitoba

BEN-MOR®



Saint-Hyacinthe, Québec



Boucherville, Québec



Barrie, Ontario



Saint-Hyacinthe
Boucherville

MONTREAL

Barrie

TORONTO



Hinsdale

Bristol



Hinsdale, New Hampshire



Bensenville

NEW YORK



Bristol, Rhode Island



Bensenville, Illinois



Jacksonville, Florida



Jacksonville

<<The Customer is King>>

The saying has survived and all have proclaimed it loudly. The voice may carry but if the results do not follow it, the Customer is not King any longer. At Ben-Mor, we prefer action to noise. That is why we whisper it in all confidence :















“Ben-Mor knows the meaning of the word “Customer”, the consequences of the word “Trust”, and the notion of faithfulness to the King; ”

“Ben-Mor’s team makes sure that its precious team spirit, mutual aid and mutual respect is constantly renewed;”

“The same team is fully engaged, on a daily basis, to reinvent the highest quality standards;”

“Finally, dear customer, we wish to assure you that at all times, we will work to offer you the best products possible at a price that will show our gratitude towards you.”

Thank you from the whole team.

CABLE ASSEMBLIES		(6 - 9)
CABLES & WIRE ROPE		(10 - 15)
COATED CABLES		(16 - 17)
ACCESSORIES		(18 - 33)
STAINLESS STEEL ACCESSORIES		(34 - 37)
LIFTING		(38 - 71)
LIFTING	YOKE[®]	(72 - 87)
LIFTING	Crosby[®]	(88 - 91)
LIFTING - Inspection & certification		(92 - 99)
CHAIN		(100 - 105)
ROPE		(106 - 107)
HOIST & TROLLEYS	KITO	(108)
PLATE CLAMP	RENFROE	(109)
TOOLS		(110 - 111)
FORESTRY • TRANSPORT • CABLE ASSEMBLIES • TIRE CHAIN • TIE-DOWN ACCESSORIES		(112 - 127)
SPECIALTY PRODUCTS - Fabric Buildings and Seismic Solutions		(128 - 131)
CONTINENTAL CABLE LLC		AS 9100 ISO 9001 MIL-SPEC (132 - 139)
MERCHANDISING		(140 - 141)
CONVERSION TABLE • SALES CONDITIONS		(142 - 144)



The Cable Assembly Specialists



Superior Quality Control

From material receiving through final outgoing inspection, quality control is carefully monitored. At our facilities, in-process quality inspection is an overall effort performed at each stage of production with documented control.

Wire rope and cable products are tested to specified levels of performance, using both destructive and non-destructive test methods. We conform to applicable Military and ISO Standards.

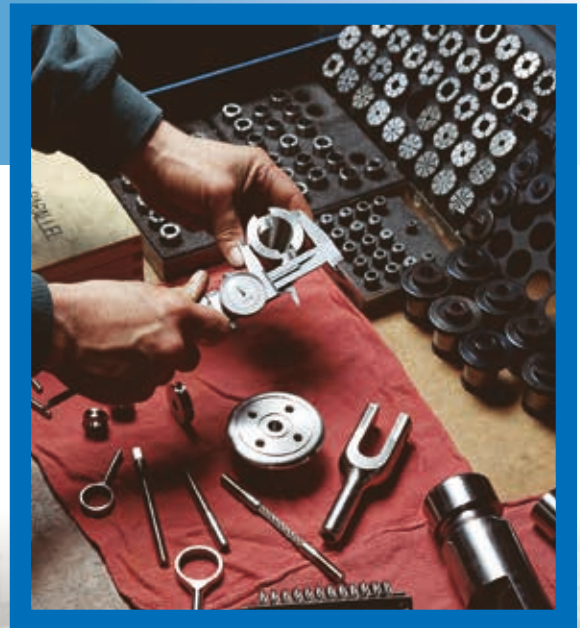

Precision-Machined Components

CNC lathes, milling machines and a full complement of secondary machines gives us the ability to manufacture fittings for many of our assembly requirements.





Automated precision cuts

With a variety of hydraulic swagers and rotary swaging machines, we are able to swage fittings from 3/64 to 3 1/2" diameter. We are also equipped to swage specialty bar and tubing onto cable. With our automated cutting machinery combined with our swagers, we can offer competitive prices.



High quality swaging

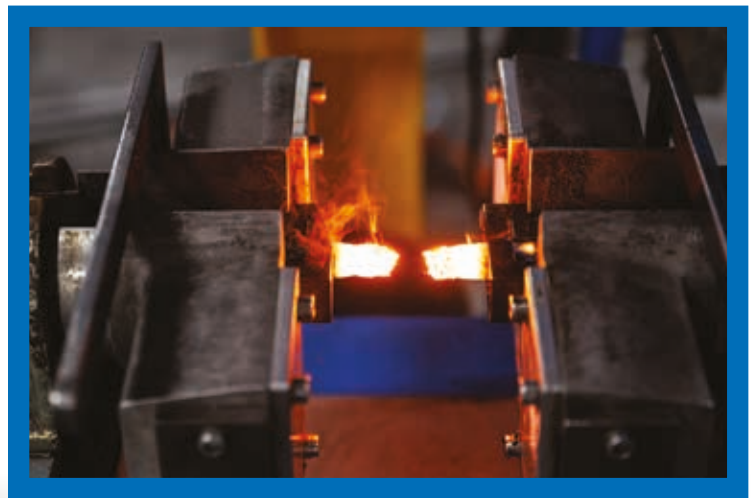

CELLULE # 16
Capacité de 500 câbles par jour
Câble non-recouvert soudé
Longueur - Maximum 300"
Diamètre - 7/16 et moins

CELLULE # 17
Capacité de 500 câbles par jour
Câble non-recouvert soudé
Longueur - Maximum 300"
Diamètre - 7/16 et moins

CELLULE # 18
Capacité de 500 câbles par jour
Câble non-recouvert soudé
Longueur - Maximum 300"
Diamètre - 7/16 et moins



On earth, in the sky or on the sea...

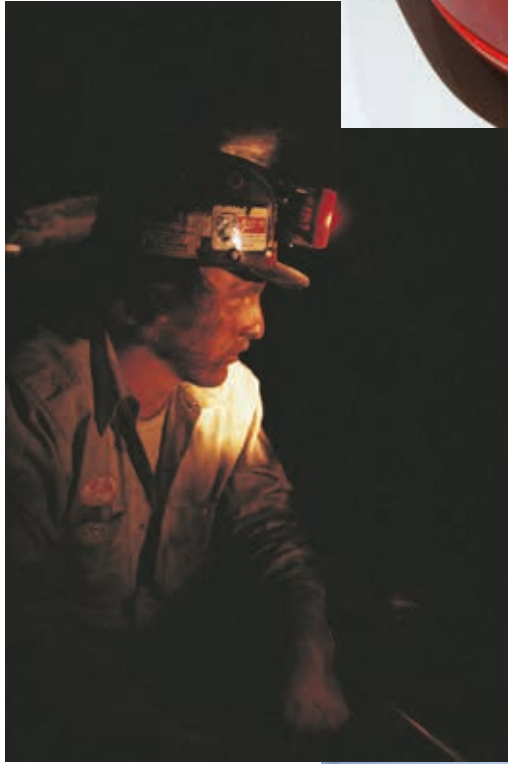







Endless possibilities !

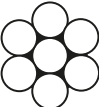

Aircraft Cable and Preformed Strands

We are qualified to manufacture aircraft cables under the detailed specification RR-W-410F and ASTM A1023/A 1023M.





Stainless Steel 304

Construction	Code	Diameter in.	Minimum Breaking Strength lbs.	Weight per 100 ft. lbs.
 1 x 7	16417S4	1/64	40	0.055
	13217S4	1/32	185	0.23
	36417S4	3/64	375	0.55
	11617S4	1/16	500	0.85
	56417S4	5/64	800	1.4
	33217S4	3/32	1,200	2.0
	01817S4	1/8	2,100	3.5
	31617S4	3/16	4,700	7.3
	01417S4	1/4	8,500	13.7
	03817S4	3/8	18,000	24.3
 1 x 19	01217S4	1/2	33,700	52.0
	364119S4	3/64	375	0.55
	116119S4	1/16	500	0.85
	564119S4	5/64	800	1.4
	332119S4	3/32	1,200	2.0
	018119S4	1/8	2,100	3.3
	532119S4	5/32	3,300	5.5
	316119S4	3/16	4,700	7.7
	014119S4	1/4	8,200	13.5
	516119S4	5/16	12,500	21.0
 7 x 7	038119S4	3/8	17,500	30.1
	012119S4	1/2	30,000	52.0
	13277S4	1/32	120	0.16
	36477S4	3/64	270	0.42
	11677S4	1/16	480	0.75
	56477S4	5/64	650	1.1
	33277S4	3/32	920	1.6
	01877S4	1/8	1,700	2.85
	53277S4	5/32	2,400	4.3
	31677S4	3/16	3,700	6.2
 7 x 19	01477S4	1/4	6,100	10.6
	51677S4	5/16	9,000	16.7
	03877S4	3/8	12,000	23.6
	01277S4	1/2	23,300	44.0
	116719S4	1/16	480	0.75
	332719S4	3/32	920	1.6
	018719S4	1/8	1,760	2.9
	532719S4	5/32	2,400	4.5
	316719S4	3/16	3,700	6.5
	732719S4	7/32	5,000	8.6
014719S4	1/4	6,400	11.0	
516719S4	5/16	9,000	17.3	
038719S4	3/8	12,000	24.3	

Type 304 stainless steel is the standard alloy for use in wire rope and cable. It has about the same strength as galvanized rope or cable but is much more corrosion resistant. It can be used in most industrial atmospheres and has acceptable corrosion resistance when use in marine and salt water.

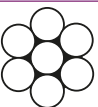

Stainless Steel 316

Construction	Code	Diameter in.	Minimum Breaking Strength lbs.	Weight per 100 ft. lbs.
 1 x 7	01417S6	1/4	7,650	13.7
	03817S6	3/8	16,200	24.3
	01217S6	1/2	30,200	52.0
 1 x 19	116119S6	1/16	467	0.85
	018119S6	1/8	1,780	3.3
	532119S6	5/32	2,800	5.5
	316119S6	3/16	4,000	7.7
	014119S6	1/4	6,900	13.5
 7 x 7	516119S6	5/16	10,600	21.0
	038119S6	3/8	14,800	30.1
	012119S6	1/2	27,000	52.0
	11677S6	1/16	360	0.75
	33277S6	3/32	700	1.6
 7 x 19	01877S6	1/8	1,360	2.85
	31677S6	3/16	2,875	6.2
	51677S6	5/16	7,600	16.7
	332719S6	3/32	700	1.6
	018719S6	1/8	1,300	2.9
	532719S6	5/32	2,000	4.5
	316719S6	3/16	2,900	6.5
014719S6	1/4	4,900	11.0	
516719S6	5/16	7,600	17.3	
038719S6	3/8	11,000	24.3	

Type 316 stainless steel is the standard high corrosion resistant steel for rope and cable. It is resistant to many chemicals in pulp and paper, photography, food processing and textile industries. It has the best pitting resistance in marine and salt water and can be used in temperatures up to 480°C (900°F).



Pre-cut cables - stainless steel

7 x 7

Dia. in	50'		100'		150'		200'		250'		500'		1,000'	
	SS304	SS316	SS304	SS316	SS304	SS316	SS304	SS316	SS304	SS316	SS304	SS316	SS304	SS316
3/64	83130	83230	81130	81230	89130	89230	88130	88230	82130	82230	80130	80230	86130	86230
1/16	83131	83231	81131	81231	89131	89231	88131	88231	82131	82231	80131	80231	86131	86231
5/64	83132	83232	81132	81232	89132	89232	88132	88232	82132	82232	80132	80232	86132	86232
3/32	83133	83233	81133	81233	89133	89233	88133	88233	82133	82233	80133	80233	86133	86233
1/8	83134	83234	81134	81234	89134	89234	88134	88234	82134	82234	80134	80234	86134	86234

7 x 19



Dia. in	50'		100'		150'		200'		250'		500'		1,000'	
	SS304	SS316	SS304	SS316	SS304	SS316	SS304	SS316	SS304	SS316	SS304	SS316	SS304	SS316
1/8	83142	83242	81142	81242	89142	89242	88142	88242	82142	82242	80142	80242	86142	86242
5/32	83143	83243	81143	81243	89143	89243	88143	88243	82143	82243	80143	80243	86143	86243
3/16	83144	83244	81144	81244	89144	89244	88144	88244	82144	82244	80144	80244	86144	86244
1/4	83145	83245	81145	81245	89145	89245	88145	88245	82145	82245	80145	80245	86145	86245
5/16	83146	83246	81146	81246	89146	89246	88146	88246	82146	82246	80146	80246	86146	86246
3/8	83147	83247	81147	81247	89147	89247	88147	88247	82147	82247	80147	80247	86147	86247



Aircraft Cable and Preformed Strands

We are qualified to manufacture aircraft cables under the detailed specification RR-W-410F and ASTM A1023/A 1023M.

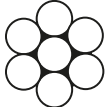
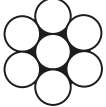
Hot Dip Galvanized

Construction	Code	Diameter in.	Minimum Breaking Strength lbs.	Weight per 100 ft. lbs.
 1 x 7 Soft guy wire	11617SOFT	1/16	100	0.85
	56417SOFT	5/64	150	1.4
	33217SOFT	3/32	250	2.0
	01817SOFT	1/8	520	3.3
 1 x 7	31617SOFT	3/16	1,150	3.8
	16417G	1/64	40	0.055
	13217G	1/32	185	0.23
	36417G	3/64	375	0.55
	11617G	1/16	500	0.85
	56417G	5/64	800	1.4
	33217G	3/32	1,200	2.0
	01817G	1/8	2,100	3.5
	01417GEHS	1/4	6,650	13.7
	03817GEHS	3/8	15,400	24.3
	71617GEHS	7/16	20,800	39.0
	01217GEHS	1/2	26,900	52.0
 1 x 19	91617GEHS	9/16	35,000	67.0
	05817GEHS	5/8	42,400	80.0
	364119G	3/64	375	0.55
	116119G	1/16	500	0.85
	564119G	5/64	800	1.4
	332119G	3/32	1,200	2.0
	018119G	1/8	2,100	3.3
	532119G	5/32	3,300	5.5
	316119G	3/16	4,700	7.7
	014119G	1/4	8,200	13.5
	516119G	5/16	12,500	21.0
	038119G	3/8	17,500	30.1

Miniature cable available on request (smaller than 1/32")



Pre-cut cables - Galvanized

7 x 7

Dia. in.	50'	100'	150'	200'	250'	500'	1,000'
	GAC	GAC	GAC	GAC	GAC	GAC	GAC
3/64	83030	81030	89030	88030	82030	80030	86030
1/16	83031	81031	89031	88031	82031	80031	86031
5/64	83032	81032	89032	88032	82032	80032	86032
3/32	83033	81033	89033	88033	82033	80033	86033
1/8	83034	81034	89034	88034	82034	80034	86034

7 x 19

Dia. in.	50'	100'	150'	200'	250'	500'	1,000'
	GAC	GAC	GAC	GAC	GAC	GAC	GAC
1/8	83042	81042	89042	88042	82042	80042	86042
5/32	83043	81043	89043	88043	82043	80043	86043
3/16	83044	81044	89044	88044	82044	80044	86044
1/4	83045	81045	89045	88045	82045	80045	86045
5/16	83046	81046	89046	88046	82046	80046	86046
3/8	83047	81047	89047	88047	82047	80047	86047

BEN-MOR Hooked on Service

Hot Dip Galvanized

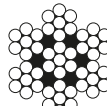
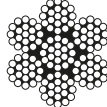
Construction	Code	Diameter in.	Minimum Breaking Strength lbs.	Weight per 100 ft. lbs.	
 7 x 7	36477G	3/64	270	0.42	
	11677G	1/16	480	0.75	
	56477G	5/64	650	1.1	
	33277G	3/32	920	1.6	
	01877G	1/8	1,700	2.85	
	53277G	5/32	2,600	4.3	
	31677G	3/16	3,700	6.2	
	01477G	1/4	6,100	10.6	
	51677G	5/16	9,200	16.7	
	03877G	3/8	13,300	23.6	
	 7 x 19	116719G	1/16	480	0.75
		332719G	3/32	1,000	1.6
018719G		1/8	2,000	2.9	
532719G		5/32	2,800	4.5	
316719G		3/16	4,200	6.5	
732719G		7/32	5,600	8.6	
014719G		1/4	7,000	11.0	
516719G		5/16	9,800	17.3	
038719G		3/8	14,400	24.3	

Miniature cable available on request (smaller than 1/32")

Galvanized, black powder paint

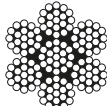
Construction	Code	Diameter in.	Minimum Breaking Strength lbs.	Weight per 100 ft. lbs.
 7 x 7	11677BLPP	1/16	480	0.75
	018719BLPP	1/8	2,000	2.9
 7 x 19	316719BLPP	3/16	4,200	6.5

Galvanized, black powder paint : Gives galvanized cable a black matte finish



6 X 19 EIPS Steel Core & Fiber Core

Diameter in.	Steel Core				Fiber Core				Weight approx./ 100 ft. lbs.
	Galvanized		Bright		Galvanized		Bright		
	Code	Minimum Breaking Strength lbs.	Code	Minimum Breaking Strength lbs.	Code	Minimum Breaking Strength lbs.	Code	Minimum Breaking Strength lbs.	
1/4	014619GEIPS	6,120	014619BEIPS	6,800	014619GFCEIPS	5,680	014619BFCEIPS	6,300	12
5/16	516619GEIPS	9,480	516619BEIPS	10,540	516619GFCEIPS	8,810	516619BFCEIPS	9,800	18
3/8	038619GEIPS	13,600	038619BEIPS	15,100	038619GFCEIPS	12,600	038619BFCEIPS	14,000	26
7/16	716619GEIPS	18,360	716619BEIPS	20,400	716619GFCEIPS	17,100	716619BFCEIPS	19,000	35
1/2	012619GEIPS	24,000	012619BEIPS	26,600	012619GFCEIPS	22,000	012619BFCEIPS	24,600	46
9/16	916619GEIPS	30,200	916619BEIPS	33,600	916619GFCEIPS	28,000	916619BFCEIPS	31,100	59
5/8	058619GEIPS	37,000	058619BEIPS	41,200	058619GFCEIPS	34,500	058619BFCEIPS	38,400	72
3/4	034619GEIPS	53,000	034619BEIPS	58,800	034619GFCEIPS	49,200	034619BFCEIPS	54,700	104
7/8	078619GEIPS	71,600	078619BEIPS	79,600	078619GFCEIPS	66,700	078619BFCEIPS	74,100	142
1	001619GEIPS	93,000	001619BEIPS	103,400	001619GFCEIPS	86,500	001619BFCEIPS	96,100	185
1 1/8	118619GEIPS	117,000	118619BEIPS	130,000	118619GFCEIPS	108,800	118619BFCEIPS	121,000	234
1 1/4	114619GEIPS	143,800	114619BEIPS	159,800	114619GFCEIPS	133,600	114619BFCEIPS	148,600	289
1 3/8	138619GEIPS	172,800	138619BEIPS	192,000	138619GFCEIPS	160,800	138619BFCEIPS	178,700	350
1 1/2	112619GEIPS	206,000	112619BEIPS	228,000	112619GFCEIPS	190,400	112619BFCEIPS	211,600	416
1 3/4	134619GEIPS	276,000	134619BEIPS	306,000	134619GFCEIPS	N/A	134619BFCEIPS	N/A	567
2	002619GEIPS	356,000	002619BEIPS	396,000	002619GFCEIPS	N/A	002619BFCEIPS	N/A	739
2 1/4	214619GEIPS	444,000	214619BEIPS	494,000	214619GFCEIPS	N/A	214619BFCEIPS	N/A	936
2 1/2	212619GEIPS	543,000	212619BEIPS	604,000	212619GFCEIPS	N/A	212619BFCEIPS	N/A	1,160

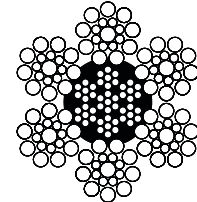

6 x 19 Steel core

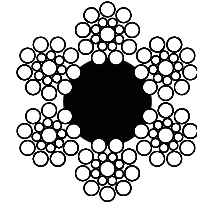

6 x 19 Fiber core

6 X 26 EIPS Steel core - Fiber core

Diameter in.	Steel Core				Fiber Core				Weight approx./ 100 ft. lbs.
	Galvanized		Bright		Galvanized		Bright		
	Code	Minimum Breaking Strength lbs.	Code	Minimum Breaking Strength lbs.	Code	Minimum Breaking Strength lbs.	Code	Minimum Breaking Strength lbs.	
1/4	014626G	6,120	014626B	6,800	014626GFCEIPS	5,680	014626BFCEIPS	6,300	12
5/16	516626G	9,480	516626B	10,540	516626GFCEIPS	8,810	516626BFCEIPS	9,800	18
3/8	038626G	13,600	038626B	15,100	038626GFCEIPS	12,600	038626BFCEIPS	14,000	26
7/16	716626G	18,360	716626B	20,400	716626GFCEIPS	17,100	716626BFCEIPS	19,000	35
1/2	012626G	24,000	012626B	26,600	012626GFCEIPS	22,000	012626BFCEIPS	24,600	46
9/16	916626G	30,200	916626B	33,600	916626GFCEIPS	28,000	916626BFCEIPS	31,100	59
5/8	058626G	37,000	058626B	41,200	058626GFCEIPS	34,500	058626BFCEIPS	38,400	72
3/4	034626G	53,000	034626B	58,800	034626GFCEIPS	49,200	034626BFCEIPS	54,700	104
7/8	078626G	71,600	078626B	79,600	078626GFCEIPS	66,700	078626BFCEIPS	74,100	142
1	001626G	93,000	001626B	103,400	001626GFCEIPS	86,500	001626BFCEIPS	96,100	185
1 1/8	118626G	117,000	118626BSUP	130,000	118626GFCEIPS	108,800	118626BFCEIPS	121,000	234
1 1/4	114626G	143,800	114626B	159,800	114626GFCEIPS	133,600	114626BFCEIPS	148,600	289
1 3/8	138626G	172,800	138626B	192,000	138626GFCEIPS	160,800	138626BFCEIPS	178,700	350
1 1/2	112626G	206,000	112626B	228,000	112626GFCEIPS	190,400	112626BFCEIPS	211,600	416
1 3/4	134626G	276,000	134626B	306,000	134626GFCEIPS	N/A	134626BFCEIPS	N/A	567
2	002626G	356,000	002626B	396,000	002626GFCEIPS	N/A	002626BFCEIPS	N/A	739
2 1/4	214626G	444,000	214626B	494,000	214626GFCEIPS	N/A	214626BFCEIPS	N/A	936
2 1/2	212626G	543,000	212626B	604,000	212626GFCEIPS	N/A	212626BFCEIPS	N/A	1,160

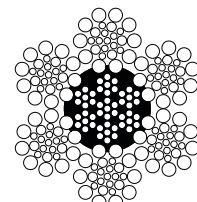

6 x 26 Steel core

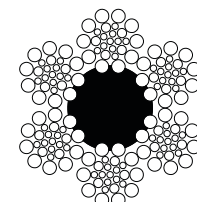

6 x 26 Fiber core

6 x 19 Stainless Steel 304

Code	Diameter in.	Minimum Breaking Strength lbs.	Weight approx. / 100 ft. lbs.
716619S4	7/16	16,300	36
012619S4	1/2	22,800	46
916619S4	9/16	28,500	59
058619S4	5/8	35,000	72
034619S4	3/4	49,600	92
078619S4	7/8	66,500	143
001619S4	1	85,400	187



6 x 19 Stainless Steel 316

Code	Diameter in.	Minimum Breaking Strength lbs.	Weight approx. / 100 ft. lbs.
716619S6	7/16	15,000	36
012619S6	1/2	19,300	46
916619S6	9/16	24,300	59
058619S6	5/8	29,800	72
034619S6	3/4	42,000	92
078619S6	7/8	58,000	143
001619S6	1	80,000	187

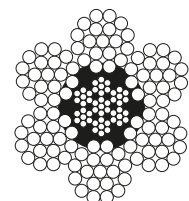

6 x 19

*Other custom cut dimensions available upon request.



6 X 36/37 EIPS Steel Core – Fiber Core

Diameter in.	Steel Core				Fiber Core				Weight approx. / 100 ft. lbs.
	Galvanized		Bright		Galvanized		Bright		
	Code	Minimum Breaking Strength lbs.	Code	Minimum Breaking Strength lbs.	Code	Minimum Breaking Strength lbs.	Code	Minimum Breaking Strength lbs.	
1/4	014636G	6,120	014636B	6,800	014636GFCEIPS	5,680	014636BFCEIPS	6,300	12
5/16	516636G	9,480	516636B	10,540	516636GFCEIPS	8,810	516636BFCEIPS	9,800	18
3/8	038636G	13,600	038636B	15,100	038636GFCEIPS	12,600	038636BFCEIPS	14,000	26
7/16	716636G	18,360	716636B	20,400	716636GFCEIPS	17,100	716636BFCEIPS	19,000	35
1/2	012636G	24,000	012636B	26,600	012636GFCEIPS	22,000	012636BFCEIPS	24,600	46
9/16	916636G	30,200	916636B	33,600	916636GFCEIPS	28,000	916636BFCEIPS	31,100	59
5/8	058636G	37,000	058636B	41,200	058636GFCEIPS	34,500	058636BFCEIPS	38,400	72
3/4	034636G	53,000	034636B	58,800	034636GFCEIPS	49,200	034636BFCEIPS	54,700	104
7/8	078636G	71,600	078636B	79,600	078636GFCEIPS	66,700	078636BFCEIPS	74,100	142
1	001636G	93,000	001636B	103,400	001636GFCEIPS	86,500	001636BFCEIPS	96,100	185
1 1/8	118636G	117,000	118636B	130,000	118636GFCEIPS	108,800	118636BFCEIPS	121,000	234
1 1/4	114636G	143,800	114636B	159,800	114636GFCEIPS	133,600	114636BFCEIPS	148,600	289
1 3/8	138636G	172,800	138636B	192,000	138636GFCEIPS	160,800	138636BFCEIPS	178,700	350
1 1/2	112636G	206,000	112636B	228,000	112636GFCEIPS	190,400	112636BFCEIPS	211,600	416
1 3/4	134636G	276,000	134636B	306,000	134636GFCEIPS	N/A	134636BFCEIPS	N/A	567
2	002636G	356,000	002636B	396,000	002636GFCEIPS	N/A	002636BFCEIPS	N/A	739
2 1/4	214636G	444,000	214636B	494,000	214636GFCEIPS	N/A	214636BFCEIPS	N/A	936
2 1/2	212636G	543,000	212636B	604,000	212636GFCEIPS	N/A	212636BFCEIPS	N/A	1,160

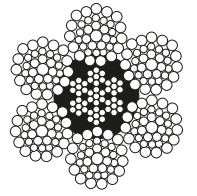

6 x 36/37 Steel core

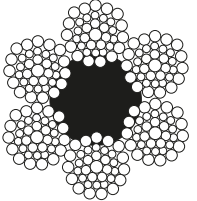

6 x 36/37 Fiber core

19 X 7 EIPS Rotation Resistant

Code	Diameter in.	Minimum Breaking Strength lbs.	Weight approx. / 100 ft. lbs.
316197BSUP	3/16	3,140	6,5
014197BSUP	1/4	5,460	11
516197BSUP	5/16	8,530	18
038197BSUP	3/8	12,300	25
716197BSUP	7/16	16,660	35
012197BSUP	1/2	21,600	45
916197BSUP	9/16	27,200	58
058197BSUP	5/8	33,600	71
034197BSUP	3/4	48,000	102
078197BSUP	7/8	65,000	139
001197BSUP	1	84,400	182

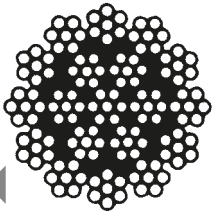

19 x 7

Cable Laid (Hot Dip Galvanized) 7 X 7 X 7

Code	Diameter in.	Minimum Breaking Strength lbs.	Weight approx. / 100 ft. lbs.
014777G	1/4	4,900	9
516777G	5/16	6,000	13
038777G	3/8	10,400	22
012777G	1/2	19,500	35
058777G	5/8	29,200	60
034777G	3/4	42,000	88
078777G	7/8	56,000	119
001777G	1	78,000	156

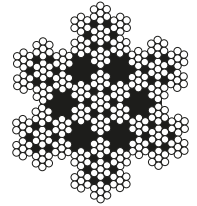

7 x 7 x 7

3 x 7 Swaged / Super Swaged

Code	Diameter in.	Minimum Breaking Strength lbs.	Weight per 100 ft. lbs.
31637BS	3/16	4,000	10
31637BSS	3/16	5,000	10
01437BSS	1/4	7,000	12



Armored Cable 1 x 19 (tow target cable)

Code	Diameter ext. in.	Diameter int. in.	Minimum Breaking Strength lbs.	Weight per 100 ft. lbs.
0181164119A	11/64	1/8 galvanized	4,000	8

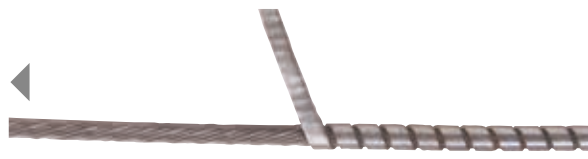

High performance wire ropes

8 x 19 - 8 x 26 (compacted/Plastic Filled Core) – 1960/2160 Grade

Code	Diameter mm	Minimum Breaking Strength lbs.	Plastic filled core	Lay direction	Weight approx. / 100 ft. lbs.
008MMBX819GCRRLCA283	8	13,040	No	Right	19,45
008MMBX819GCLRRLCA283	8	13,040	No	Left	19,45
010MMBX819GCRRLCA283	10	20,770	No	Right	30,85
010MMBX819GCLRRLCA283	10	20,770	No	Left	30,85
011MMBX819GCRRLCA283	11	25,130	No	Right	37,56
011MMBX819GCLRRLCA283	11	25,130	No	Left	37,56
012MMDP826GPRRLC82	12	30,460	Yes	Right	44,27
012MMDP826GPLRLC82	12	30,460	Yes	Left	44,27
013MMDP826GPRRLC82	13	35,743	Yes	Right	51,98
012MMDP826GPLRLC82	13	35,743	Yes	Left	51,98
016MMKP826GPRRLB51	16	50,580	Yes	Right	79,15
016MMKP826GPLRLB51	16	50,580	Yes	Left	79,15
018MMKP826GPRRLB51	18	64,068	Yes	Right	99,94
018MMKP826GPLRLB51	18	64,068	Yes	Left	99,94
019MMKP826GPRRLB51	19	71,486	Yes	Right	111,34
019MMKP826GPLRLB51	19	71,486	Yes	Left	111,34
020MMKP826GPRRLB51	20	79,129	Yes	Right	123,41
020MMKP826GPLRLB51	20	79,129	Yes	Left	123,41

* MBS may vary

**Other wire rope dimensions available upon request

***Other options available upon request: grade, reversed core, special lubrication, rotary swaged, etc.

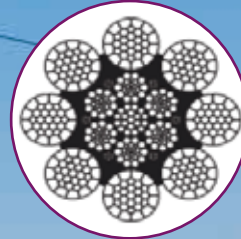

8 x 19
(compacted)

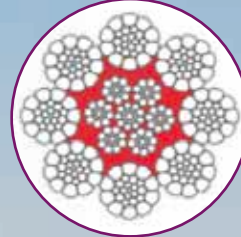

8 x 26
(compacted)



High performance wire ropes



- Features :**
- Crane rope.
 - Wire rope with the best rotation resistance.
 - Made with compacted outer strands and inner strands.
 - Extremely high breaking strength
 - Very strong resistance against drum crushing.
 - Fully lubricated and made of galvanized wires.
 - This rope is "Right Lang".

35 X 7 (compacted) Non-rotating – 2160 Grade

Code	Diameter mm	Minimum Breaking Strength (lbs)	Weight approx. / 100 ft. lbs
008MM357	8	12,897	20,8
010MM357	10	22,000	34,2
012MM357	12	31,600	49,2
013MM357	13	37,200	57,8
014MM357	14	43,100	67
015MM357	15	49,680	74,45
016MM357	16	56,300	87,8
018MM357	18	71,486	106,65
019MM357	19	79,400	123,4
020MM357	20	87,900	136,8
022MM357	22	106,400	165,6

Other wire rope dimensions available upon request

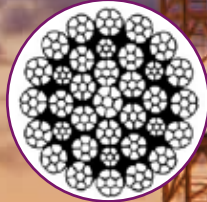

35 x 7 (compacted)



Our Extruders are equipped with laser monitors that constantly measure every centimeter of the coated cable.

These machines insure the highest quality control over the outside diameter of the coatings during production.



Coated Cable

Cable / Nominal diameter in	Outside / Coating diameter in.	Weight approx. / 100 ft. lbs
1/32	3/64	0.25
3/64	1/16	0.60
1/16	3/32	0.95
1/16	1/8	1.00
3/32	1/8	2.20
3/32	5/32	2.60
3/32	3/16	2.90
1/8	5/32	4.05
1/8	3/16	4.65
1/8	1/4	5.05
5/32	3/16	5.40
5/32	7/32	5.50
3/16	7/32	6.80
3/16	1/4	7.90
3/16	5/16	10.25
1/4	5/16	12.50
5/16	3/8	19.75
5/16	7/16	21.95
3/8	7/16	28.20
3/8	1/2	30.50
3/8	9/16	33.20
7/16	1/2	37.50
7/16	9/16	40.20
1/2	9/16	48.75
1/2	5/8	52.00
1/2	11/16	55.10
5/8	11/16	75.40
5/8	3/4	79.10
5/8	7/8	87.30
3/4	7/8	112.20
3/4	1	122.00
1	1 1/8	197.50
1	1 1/4	217.00
1 1/8	1 1/4	266.00
1 1/4	1 3/8	316.00
1 1/4	1 1/2	356.00

- Miniature cable available on request (smaller than 1/32")
- Galvanized, stainless steel 304 and 316 cable available

Nylon 6 (standard)
Nylon 11 (high performance)
Vinyl, urethane
Polypropylene
Polyester (Hytrell)

TOLERANCES

Standard outside diameter tolerances for plastic coated cables.

O.D. of Jacket		Standard Tolerance
Up to	.125 (1/8")	+/-0.007"
.126 to	.250 (1/4")	+/-0.009"
.251 to	.375 (3/8")	+/-0.010"
.376 to	.500 (1/2")	+/-0.015"
.501 to	.750 (3/4")	+/-0.020"
.751 to	1.000 (1")	+/-0.030"
1.001 to	1.250 (1 1/4")	+/-0.040"
1.251 to	1.500 (1 1/2")	+/-0.050"

WARNING

Applying fittings over a plastic jacket is not recommended.

Any fitting pressed or swaged over a plastic jacket will not hold to the nominal break strength of the cable.

CUSTOMER SUPPLIED MATERIAL

We offer a coating service for your cable subject to certain conditions.

1. The cable must be dry-oil free.
2. No protruding or broken wires.
3. No obvious defects (such as high or uneven strands).
4. Cable must be evenly wound (thread lay) on the reels.

We have the right to refuse to coat your cable if in our opinion we cannot produce a satisfactory finished product, or we determine that the cable may cause damage to our extruders.



We have engineered our own mixes to offer you superior quality colors.

Copper Duplex Sleeves or Copper Zinc Plated Duplex Sleeves

Code Copper	Code Copper Zinc Plated	For Cable Diameter in.	Weight / each approx lbs.
COS-132	CZOS-132	1/32	.001
COS-364	CZOS-364	3/64	.002
COS-116	CZOS-116	1/16	.003
COS-332	CZOS-332	3/32	.005
COS-018	CZOS-018	1/8	.016
COS-532	CZOS-532	5/32	.022
COS-316	CZOS-316	3/16	.051
COS-732	CZOS-732	7/32	.044
COS-014	CZOS-014	1/4	.078
COS-516	CZOS-516	5/16	.115
COS-038	CZOS-038	3/8	.146
COS-012	CZOS-012	1/2	.372



Aluminium Duplex Sleeves

Hour glass shape

Code	For Cable Diameter in.	Weight / each approx lbs.
AOS-132	1/32	.0002
AOS-364	3/64	.001
AOS-116	1/16	.001
AOS-564	5/64	.002
AOS-332	3/32	.003
AOS-018	1/8	.006
AOS-532	5/32	.008
AOS-316	3/16	.016
AOS-732	7/32	.022
AOS-014	1/4	.025
AOS-516	5/16	.045
AOS-038	3/8	.061
AOS-716	7/16	.118
AOS-012	1/2	.176



Aluminium Oval Sleeves

Code	For Cable Diameter in.	Weight / each approx lbs.
AOS-058OVALE	5/8	0.079
AOS-916OVALE	9/16	0.099
AOS-034OVALE	3/4	0.145
AOS-078OVALE	7/8	0.196
AOS-001OVALE	1	0.990
AOS-118OVALE	1 1/8	1.370
AOS-114OVALE	1 1/4	2.025

Other sizes available on request.



Federal Specifications MS51844

Tin or Nickel plating available on request

Copper Stop Sleeves

Code	For Cable Diameter in.	Weight / each approx lbs.
CSS-132	1/32	.001
CSS-364	3/64	.002
CSS-116	1/16	.002
CSS-332	3/32	.008
CSS-018	1/8	.007
CSS-532	5/32	.012
CSS-316	3/16	.105
CSS-732	7/32	.186
CSS-014	1/4	.061
CSS-516	5/16	.052



Not intended for overhead lifting

Aluminium Stop Sleeves

chamfered

Code	For Cable Diameter in.	Weight / each approx lbs.
ASS-116	1/16	.001
ASS-564	5/64	.002
ASS-332	3/32	.003
ASS-018	1/8	.002
ASS-532	5/32	.004
ASS-316	3/16	.004
ASS-014	1/4	.021
ASS-516	5/16	.022
ASS-038	3/8	.022



Not intended for overhead lifting

Steel Sleeves



Code	Rope Size in.	Weight per 100 lbs.	Before Swage Dimensions in.					After Swage Dimensions in. (max)	Standard Die
			C	E	M	N	O		
BAS505014	1/4	5	.66	1.00	.31	.47	.28	.57	
BAS505516	5/16	14	.91	1.50	.38	.62	.44	.75	
BAS505038	3/8	14	.91	1.50	.47	.66	.39	.75	
BAS505716	7/16	33	1.22	2.00	.53	.85	.65	1.01	
BAS505012	1/2	29	1.22	2.00	.63	.91	.56	1.01	
BAS505916	9/16	64	1.47	2.75	.70	1.03	.63	1.24	
BAS505058	5/8	56	1.47	2.75	.75	1.09	.63	1.24	
BAS505034	3/4	88	1.72	3.19	.91	1.28	.84	1.46	
BAS505078	7/8	131	2.03	3.56	1.03	1.53	1.00	1.68	

Code	Rope Size in.	Weight per 100 lbs.	Before Swage Dimensions in.					After Swage Dimensions in. (max)
			C	E	M	N	O	
BAS505001	1	195	2.28	4.00	1.16	1.72	1.13	1.93
BAS505118	1 1/8	260	2.50	4.81	1.28	1.94	1.25	2.13
BAS505114	1 1/4	355	2.78	5.19	1.44	2.16	1.41	2.32
BAS505138	1 3/8	423	3.00	5.81	1.56	2.38	1.56	2.52
BAS505112	1 1/2	499	3.25	6.25	1.69	2.63	1.69	2.71
BAS505134	1 3/4	805	3.84	7.25	1.94	3.13	1.97	3.10
BAS505002	2	1,132	4.38	8.50	2.25	3.63	2.25	3.56
BAS505214	2 1/4	1,936	5.03	9.56	2.50	4.03	2.53	4.12
BAS505212	2 1/2	2,352	5.50	10.50	2.75	4.50	2.81	4.50

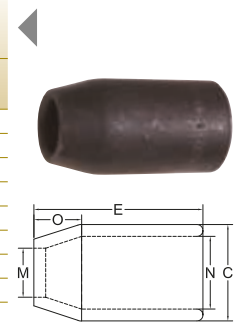

Steel Swage Buttons

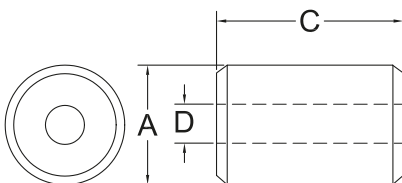

Code	For Cable diameter in.	Weight / each approx lbs.	Dimensions in.			After Swage Dimension in.	
			A	C	D	A	C
SBS409018	1/8	.02	0.438	0.526	0.141	0.40	0.61
SBS409316	3/16	.04	0.568	0.737	0.203	0.52	0.84
SBS409014	1/4	.07	0.632	1.000	0.281	0.58	1.20
SBS409516	5/16	.15	0.852	1.150	0.344	0.77	1.33
SBS409038	3/8	.20	0.875	1.500	0.406	0.77	1.69
SBS409716	7/16	.39	1.136	1.684	0.469	1.03	1.94
SBS409012	1/2	.54	1.278	1.840	0.531	1.16	2.17
SBS409916	9/16	.73	1.420	2.040	0.594	1.29	2.41
SBS409058	5/8	1.07	1.562	2.421	0.656	1.42	2.89
SBS409034	3/4	1.36	1.704	2.720	0.797	1.55	3.25
SBS409078	7/8	2.24	2.000	3.263	0.938	1.80	3.86
SBS409001	1	3.27	2.272	3.684	1.063	2.05	4.36
SBS409118	1 1/8	4.59	2.563	4.050	1.187	2.30	4.81
SBS409114	1 1/4	7.89	2.840	4.560	1.320	2.56	5.42
SBS409112	1 1/2	11.01	3.408	5.470	1.578	TBD	TBD



Standard Eye Length for Ben-Mor Cable Assemblies

Dimensions in.		
Cable Diameter	S After Swage	Tolerances (+/-)
3/64	1/2	1/32
1/16	5/8	1/32
5/64	5/8	1/32
3/32	3/4	1/32
1/8	1 1/4	1/16
5/32	1 1/2	3/32
3/16	2	1/8
7/32	3	5/32
1/4	4	3/16
5/16	5	1/4
3/8	6	5/16
7/16	7	3/8
1/2	8	7/16
9/16	9	7/16
5/8	10	1/2
3/4	12	5/8
7/8	14	3/4
1	16	3/4

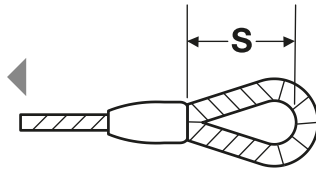

Other dimensions available upon request.

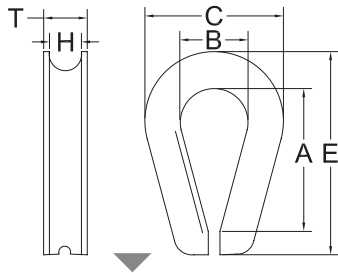

HD Thimbles (hot dip galvanized)

Code	For Cable Diameter in.	Weight / each approx lbs.	Dimensions in.					
			A	B	C	E	H	T
HDTG-014	1/4	0.080	1.62	.88	1.50	2.19	.28	.41
HDTG-516	5/16	0.140	1.88	1.06	1.81	2.50	.34	.50
HDTG-038	3/8	0.260	2.12	1.12	2.12	2.88	.41	.63
HDTG-716	7/16	0.300	2.38	1.25	2.38	3.25	.47	.72
HDTG-012	1/2	0.440	2.75	1.50	2.75	3.62	.59	.89
HDTG-916	9/16	0.510	2.75	1.50	2.75	3.62	.59	.89
HDTG-058	5/8	0.740	3.25	1.75	3.12	4.25	.66	1.00
HDTG-034	3/4	1.150	3.75	2.00	3.81	5.00	.78	1.22
HDTG-078	7/8	1.500	4.25	2.25	4.25	5.50	.94	1.38
HDTG-001	1	2.250	4.50	2.50	4.75	6.12	1.06	1.56
HDTG-114	1 1/8 - 1 1/4	3.360	5.12	2.88	5.88	7.00	1.31	1.88
HDTG-138	1 1/4 - 1 3/8	8.17	6.50	3.50	6.81	9.08	1.44	2.25
HDTG-112	1 1/2	10.00	6.25	3.50	7.12	9.00	1.56	2.62
HDTG-134	1 3/4	17.75	9.00	4.50	8.50	12.19	1.87	3.06
HDTG-002	2	27.75	12.00	6.00	10.38	15.12	2.09	3.38

Federal Specification: FF-T-276B Other dimensions available upon request.

Round Eye Thimbles (zinc plated)

Code	For Cable Diameter in.	Weight / ea. lbs.	Dimensions in.	
			E	G
RETZC-018281	3/32 - 1/8	0.02	0.625	0.281
RETZC-018359	3/32 - 1/8	0.02	0.625	0.359

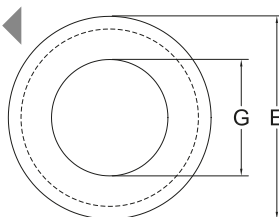

BEN-MOR Hooked on Service

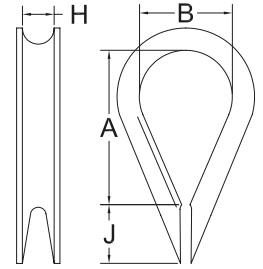

AN Thimbles (zinc plated)

Code	For Cable Diameter in.	Weight / each approx lbs.	Dimensions in.			
			A	B	H	J
ANTZ-116	3/64 - 1/16 - 5/64	.002	43/64	.350	3/32	3/16
ANTZ-018	3/32 - 7/64 - 1/8	.004	45/64	.350	9/64	7/32
ANTZ-532	5/32	.006	51/64	.400	11/64	7/32
ANTZ-316	3/16	.010	1	.500	13/64	5/16
ANTZ-014	7/32 - 1/4	.015	1 13/32	.700	17/64	13/32
ANTZ-516	9/32 - 5/16	.035	1 51/64	.900	21/64	7/16
ANTZ-038	3/8	.085	2	1.000	25/64	5/8

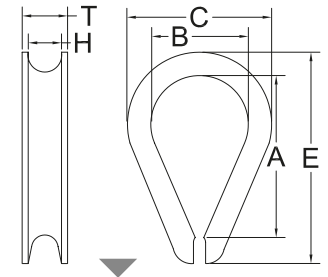

Standard Thimbles (hot dip galvanized)

Code	For Cable Diameter in.	Weight / each approx lbs.	Dimensions in.					
			A	B	C	E	H	T
STD TG-018	1/8 - 5/32	.035	1.31	.69	1.06	1.94	.16	.25
STD TG-316	3/16	.035	1.31	.69	1.06	1.94	.22	.31
STD TG-014	1/4	.035	1.31	.69	1.06	1.94	.28	.38
STD TG-516	5/16	.040	1.50	.81	1.25	2.13	.34	.44
STD TG-038	3/8	.075	1.63	.94	1.47	2.38	.41	.53
STD TG-012	1/2	.140	1.88	1.13	1.75	2.75	.53	.69
STD TG-058	5/8	.360	2.25	1.38	2.38	3.50	.66	.91
STD TG-034	3/4	.500	2.50	1.63	2.69	3.75	.78	1.08
STD TG-078	7/8	.900	3.50	1.88	3.19	5.00	.94	1.27
STD TG-001	1	1.04	4.25	2.50	3.75	5.69	1.06	1.39

Federal Specification: FF-T-276B Other dimensions available upon request.

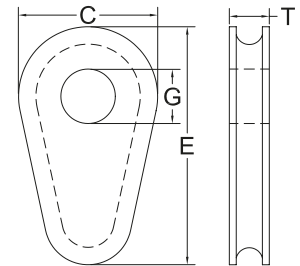

Solid Wire Rope Thimbles

Code	For Cable Diameter in.	Weight / ea. lbs.	Dimensions in.			
			C	E	G	T
S412-012	1/2	2.25	2 1/8	2 13/16	1	7/8
S412-058	5/8	6.00	3 3/8	4 11/16	1 3/16	1 1/8
S412-034	3/4	5.12	3 3/8	4 11/16	1 3/8	1 3/8
S412-078	7/8	10.00	4 1/2	6 1/16	1 5/8	1 5/8
S412-001	1	10.00	4 1/2	6 1/16	2	1 13/16
S412-118	1 1/8	10.00	5 3/8	7 1/4	2 1/4	2 1/16
S412-114	1 1/4 - 1 3/8	10.00	5 3/8	7 1/4	2 1/2	2 5/16

Wire Rope Clips Brown Pin® (drop-forged, hot dip galvanized)

Code	For Cable Diameter in.	Weight / ea. lbs.	Nut Torque ft./lbs.	Wire Rope Clips Min. Qty	Turn Back Length in.	Dimensions in.	
						A	D
WRCDF-BP-018	1/8	0.06	4.5	2	3 1/4	0.719	12 - 24
WRCDF-BP-316	3/16	0.10	7.5	2	3 3/4	0.938	1/4 - 20
WRCDF-BP-014	1/4	0.19	15	2	4 3/4	1.031	5/16 - 18
WRCDF-BP-516	5/16	0.28	30	2	5 1/4	1.313	3/8 - 16
WRCDF-BP-038	3/8	0.48	45	2	6 1/2	1.500	7/16 - 14
WRCDF-BP-716	7/16	0.76	65	2	7	1.875	1/2 - 13
WRCDF-BP-012	1/2	0.80	65	3	11 1/2	1.875	1/2 - 13
WRCDF-BP-916	9/16	1.04	95	3	12	2.250	9/16 - 12
WRCDF-BP-058	5/8	1.10	95	3	12	2.375	9/16 - 12
WRCDF-BP-034	3/4	1.42	130	4	18	2.750	5/8 - 11

Federal Specification : FF-C-450

Other dimensions available upon request. Stamped with size on the saddle.

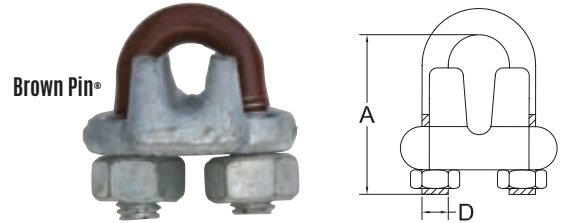

Code	For Cable Diameter in.	Weight / ea. lbs.	Nut Torque ft./lbs.	Wire Rope Clips Min. Qty	Turn Back Length in.	Dimensions in.	
						A	D
WRCDF-BP-078	7/8	2.12	225	4	19	3.125	3/4 - 10
WRCDF-BP-001	1	2.52	225	5	26	3.500	3/4 - 10
WRCDF-BP-118	1 1/8	2.90	225	6	34	3.875	3/4 - 10
WRCDF-BP-114	1 1/4	4.30	360	7	44	4.250	7/8 - 9
WRCDF-BP-112	1 1/2	5.40	360	8	54	4.940	7/8 - 9

Wire Rope Clips (malleable, zinc plated)

Code	For Cable Diameter in.	Weight / ea. lbs.	Nut Torque ft./lbs.	Wire Rope Clips Min. Qty	Turn Back Length in.	Dimensions in.	
						A	D
WRCMA-116	1/16	0.03	3.0	3	3	0.630	8 - 32
WRCMA-018	3/32 - 1/8	0.04	3.0	3	4 3/4	0.780	10 - 24
WRCMA-316	3/16	0.06	4.5	3	5 1/2	0.875	10 - 24
WRCMA-014	1/4	0.12	15	3	7	1.188	5/16 - 18
WRCMA-516	5/16	0.14	15	3	7 3/4	1.188	5/16 - 18
WRCMA-038	3/8	0.21	30	3	9 1/2	1.563	3/8 - 16
WRCMA-716	7/16	0.27	40	3	10 1/4	1.625	3/8 - 16
WRCMA-012	1/2	0.35	45	4	15 1/4	2.000	7/16 - 14
WRCMA-058	5/8	0.58	75	4	16	2.313	1/2 - 13
WRCMA-034	3/4	0.84	75	5	22 1/4	2.563	9/16 - 12
WRCMA-078	7/8	1.24	130	5	23 1/2	3.063	5/8 - 11
WRCMA-001	1	1.50	130	6	31	3.375	5/8 - 11
WRCMA-118	1 1/8	2.60	200	7	39 1/2	3.875	3/4 - 10
WRCMA-114	1 1/4	3.60	200	8	50	3.875	3/4 - 10

Not intended for overhead lifting

Federal Specification : FF-C-450

Other dimensions available upon request. Stamped with size on the saddle.

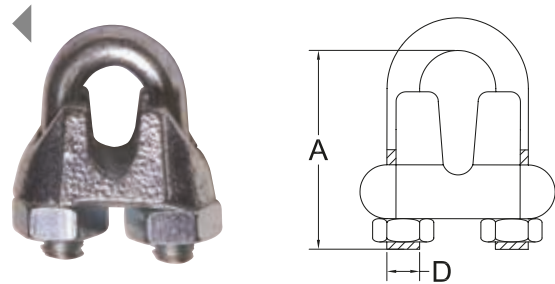

INSTRUCTIONS FOR USE OF WIRE ROPE CLIPS :

Wire rope clips are not to be used on coated cable without first stripping off the coating. Apply U-Bolt over dead end of wire rope. Live end rests in saddle. (Never saddle a dead horse !)

See following table for indications concerning quantity of clips to be installed and "turn back" lengths required on specific diameters of rope. These indications are valid for most cable "constructions". Please contact our specialists for more information.



Screw Pin Anchor Shackles, non-rated, Commercial (hot dip galvanized)

Code	Size in.	Working Load Limit TON	Weight / ea. lbs.	Dimensions in.						
				A	B	D	G	H	L	T
SPAS-316	3/16	1/4	0.06	13/16	5/8	3/16	.260	.400	1/4	1/2
SPAS-014	1/4	1/3	0.10	1	3/4	1/4	.350	.500	5/16	9/16
SPAS-516	5/16	1/2	0.19	1 3/16	13/16	5/16	.425	.525	3/8	11/16
SPAS-038	3/8	3/4	0.31	1 3/8	1	3/8	.500	.675	7/16	13/16
SPAS-716	7/16	1	0.38	1 5/8	1 1/8	7/16	.550	.750	1/2	15/16
SPAS-012	1/2	1 1/2	0.72	1 7/8	1 1/4	1/2	.660	.775	5/8	1 1/16
SPAS-058	5/8	2 1/4	1.37	2 3/8	1 11/16	5/8	.610	1.000	3/4	1 3/8
SPAS-034	3/4	3 1/4	2.35	2 5/8	2	3/4	.975	1.250	7/8	1 1/2
SPAS-078	7/8	4 1/3	3.62	3	2 1/4	7/8	1.000	1.500	1	1 7/8
SPAS-001	1	5 1/2	5.00	4	2 5/8	1	1.200	1.675	1 1/8	2 1/4

Safety Factor 5:1

Not intended for overhead lifting

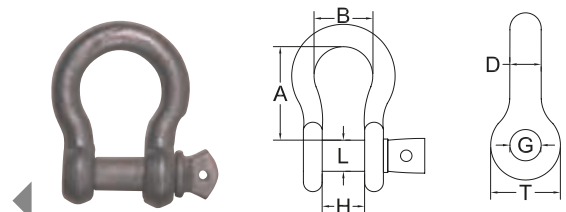



Bolt Type Anchor Shackles Brown Pin®, rated (drop forged, hot dip galvanized)

Code	Size in.	Working Load Limit TON	Weight / ea. lbs.	Dimensions in.									
				A		B	D	G	H		L	T	
				Nominal	±	Min	Min	Max	Nominal	±	Min	Max	
SPAS2130BP038	3/8	1	0.30	1 7/16	1/8	15/16	3/8	15/32	21/32	1/16	7/16	1 1/2	
SPAS2130BP012	1/2	2	0.79	1 7/8	1/8	1 3/16	1/2	23/32	13/16	1/16	5/8	1 3/8	
SPAS2130BP058	5/8	3 1/4	1.68	2 13/32	1/8	1 1/2	5/8	27/32	1 1/16	1/16	3/4	1 7/8	
SPAS2130BP034	3/4	4 3/4	2.28	2 27/32	1/4	1 3/4	3/4	31/32	1 1/4	1/16	7/8	2 1/8	
SPAS2130BP078	7/8	6 1/2	3.95	3 5/16	1/4	2	7/8	1 3/32	1 7/16	1/16	1	2 3/8	
SPAS2130BP001	1	8 1/2	6.12	3 3/4	1/4	2 5/16	1	1 7/32	1 11/16	1/16	1 1/8	2 5/8	
SPAS2130BP118	1 1/8	9 1/2	8.27	4 1/4	1/4	2 5/8	1 1/8	1 11/32	1 13/16	1/16	1 1/4	2 7/8	
SPAS2130BP114	1 1/4	12	11.71	4 11/16	1/4	2 7/8	1 1/4	1 15/32	2 1/32	1/16	1 3/8	3 1/4	
SPAS2130BP138	1 3/8	13 1/2	15.38	5 1/4	1/4	3 1/4	1 3/8	1 5/8	2 1/4	1/8	1 1/2	3 1/2	
SPAS2130BP112	1 1/2	17	20.80	5 3/4	1/4	3 3/8	1 1/2	1 3/4	2 3/8	1/8	1 5/8	3 3/4	
SPAS2130BP134	1 3/4	25	33.91	7	1/4	4 1/2	1 3/4	2 5/32	2 7/8	1/8	2	4 1/2	
SPAS2130BP002	2	35	52.25	7 3/4	1/2	5 1/4	2	2 13/32	3 1/4	1/8	2 1/4	5 1/4	
SPAS2130BP212	2 1/2	55	94.00	10 3/16	1/2	7	2 3/4	2 13/16	4 1/8	1/8	2 3/4	6	

Safety Factor 6:1

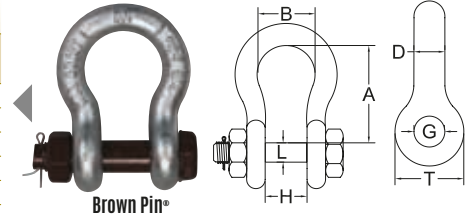

Federal Specification : RR-C-271G-16 and ASME B30.26.
 Forged steel, quenched and tempered.
 Alloy brown pin stamped with the manufacturer identification code and HS for "High Strength".
 Body stamped with BM identification code, WLL (working load limit), Size, 45° angle marks and traceability code.

Screw Pin Anchor Shackles Brown Pin®, rated (drop forged, hot dip galvanized)

Code	Size in.	Working Load Limit TON	Weight / ea. lbs.	Dimensions in.									
				A		B	D	G	H		L	T	
				Nominal	±	Min	Min	Max	Nominal	±	Min	Max	
SPASX-BP-316	3/16	1/3	0.06	7/8	1/16	9/16	3/16	5/16	3/8	1/16	1/4	5/8	
SPASX-BP-014	1/4	1/2	0.10	1 1/8	1/16	3/4	1/4	13/32	15/32	1/16	5/16	7/8	
SPASX-BP-516	5/16	3/4	0.19	1 1/4	1/16	13/16	5/16	15/32	17/32	1/16	3/8	1	
SPASX-BP-038	3/8	1	0.31	1 7/16	1/8	15/16	3/8	17/32	21/32	1/16	7/16	1 1/8	
SPASX-BP-716	7/16	1 1/2	0.38	1 11/16	1/8	1 1/16	7/16	19/32	23/32	1/16	1/2	1 1/4	
SPASX-BP-012	1/2	2	0.72	1 7/8	1/8	1 3/16	1/2	23/32	13/16	1/16	5/8	1 3/8	
SPASX-BP-058	5/8	3 1/4	1.37	2 13/32	1/8	1 1/2	5/8	27/32	1 1/16	1/16	3/4	1 7/8	
SPASX-BP-034	3/4	4 3/4	2.35	2 27/32	1/4	1 3/4	3/4	31/32	1 1/4	1/16	7/8	2 1/8	
SPASX-BP-078	7/8	6 1/2	3.62	3 5/16	1/4	2	7/8	1 3/32	1 7/16	1/16	1	2 3/8	
SPASX-BP-001	1	8 1/2	5.00	3 3/4	1/4	2 5/16	1	1 7/32	1 11/16	1/16	1 1/8	2 5/8	
SPASX-BP-118	1 1/8	9 1/2	7.41	4 1/4	1/4	2 5/8	1 1/8	1 11/32	1 13/16	1/16	1 1/4	2 7/8	
SPASX-BP-114	1 1/4	12	9.50	4 11/16	1/4	2 7/8	1 1/4	1 15/32	2 1/32	1/16	1 3/8	3 1/4	
SPASX-BP-138	1 3/8	13 1/2	13.53	5 1/4	1/4	3 1/4	1 3/8	1 5/8	2 1/4	1/8	1 1/2	3 1/2	
SPASX-BP-112	1 1/2	17	17.20	5 3/4	1/4	3 3/8	1 1/2	1 3/4	2 3/8	1/8	1 5/8	3 3/4	
SPASX-BP-134	1 3/4	25	27.78	7	1/4	4 1/2	1 3/4	2 5/32	2 7/8	1/8	2	4 1/2	
SPASX-BP-002	2	35	45.0	7 3/4	1/2	5 1/4	2	2 13/32	3 1/4	1/8	2 1/4	5 1/4	
SPASX-BP-212	2 1/2	55	85.0	10 1/2	1/2	6 3/4	2 1/2	2 29/32	4 1/8	1/8	2 3/4	6 1/4	

Safety Factor 6:1

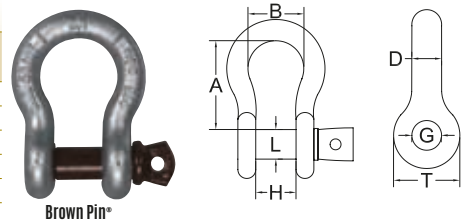

Federal Specification : RR-C-271G-16 and ASME B30.26.
 Forged steel, quenched and tempered.
 Alloy brown pin stamped with the manufacturer identification code and HS for "High Strength".
 Body stamped with BM identification code, WLL (working load limit), Size, 45° angle marks and traceability code.

Shackles Ben-Mor

<<Brown Pin®>>

US Federal Specs RR-C-271G-16

ASME B30.26

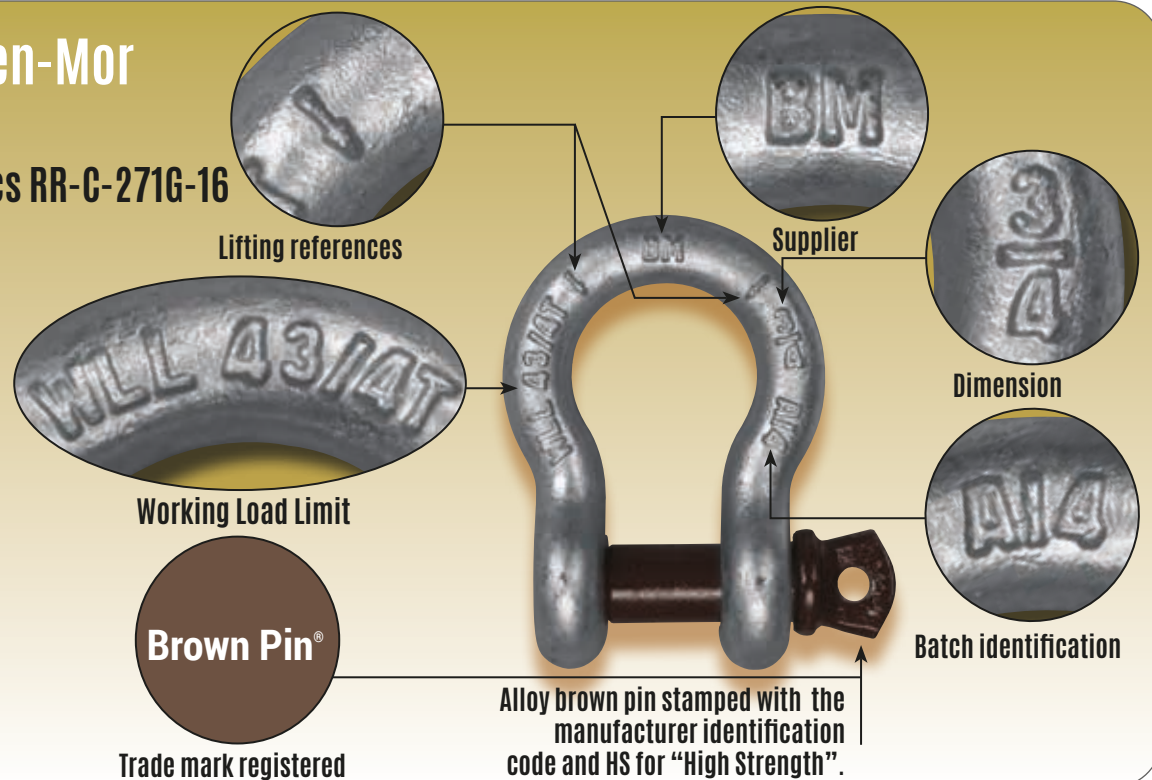

Alloy brown pin stamped with the manufacturer identification code and HS for "High Strength".

Shoulder Nut Eye Bolt • Installation for Angular Loading

Thickness of spacers must exceed this distance between the bottom of the load and the last thread of the eye bolt.

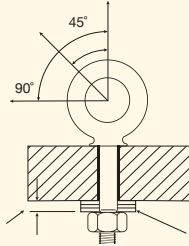

Place washers or spacers between nut and load, so that when the nut is tightened securely, the shoulder is secured flush against the load surface.

The thread shank must protrude through the load sufficiently to allow full engagement of the nut. If the eye bolt protrudes so far through the load that the nut cannot be tightened securely against the load, use properly sized washers to take up the excess space BETWEEN THE NUT AND THE LOAD.

Shoulder Nut Eye Bolts - (galvanized, drop-forged, carbon steel quenched and tempered)

Code	Working Load Limit lbs.	Weight / ea. lbs.	Dimensions in.				
			D	F	G	P	Q
SNEB-014002	500	0.07	1/4	2 3/4	1/2	1 1/2	2
SNEB-014004	500	0.09	1/4	4 3/4	1/2	2 1/2	4
SNEB-516214	800	0.12	5/16	3 1/4	5/8	1 1/2	2 1/4
SNEB-516414	800	0.19	5/16	5 1/4	5/8	2 1/2	4 1/4
SNEB-038212	1,200	0.22	3/8	3 5/8	3/4	1 1/2	2 1/2
SNEB-038412	1,200	0.25	3/8	5 5/8	3/4	2 1/2	4 1/2
SNEB-012314	2,200	0.43	1/2	5	1	1 1/2	3 1/4
SNEB-012006	2,200	0.56	1/2	7 1/2	1	3	6
SNEB-058004	3,500	0.70	5/8	5 7/8	1 1/4	2	4
SNEB-058006	3,500	1.00	5/8	7 7/8	1 1/4	3	6
SNEB-034412	5,200	1.44	3/4	6 3/4	1 1/2	2	4 1/2
SNEB-034006	5,200	1.70	3/4	8 1/4	1 1/2	3	6
SNEB-078005	7,200	2.25	7/8	7 3/4	1 3/4	2 1/2	5
SNEB-001006	10,000	3.67	1	9	2	3	6
SNEB-001009	10,000	4.23	1	12	2	4	9
SNEB-114008	15,200	6.50	1 1/4	11 3/4	2 1/2	4	8
SNEB-114012	15,200	7.95	1 1/4	15 3/4	2 1/2	4	12
SNEB-112015	21,400	14.25	1 1/2	19 1/2	3	6	15

Safety Factor 5:1

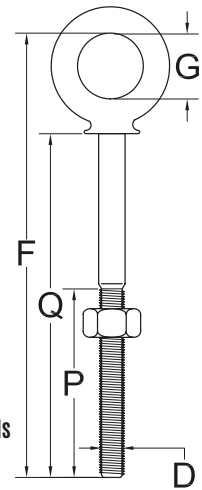

UNC threads

Shoulder Type Machinery Eye Bolts

(self-colored, drop-forged, carbon steel quenched and tempered)

Code	Working Load Limit lbs.	Weight / ea. lbs.	Dimensions in.			
			D	F	G	P
STEB-014001SC	500	0.05	1/4	2 1/8	3/4	1
STEB-516118SC	900	0.10	5/16	2 1/2	7/8	1 1/8
STEB-038114SC	1,300	0.16	3/8	2 15/16	1	1 1/4
STEB-012112SC	2,400	0.35	1/2	3 1/4	1 1/8	1 1/2
STEB-058134SC	4,000	0.67	5/8	4 1/8	1 1/4	1 3/4
STEB-034002SC	5,000	1.00	3/4	4 3/8	1 1/2	2
STEB-078214SC	7,000	1.63	7/8	5 1/8	1 3/4	2 1/4
STEB-001212SC	9,000	2.22	1	5 7/8	2	2 1/2
STEB-114003SC	15,000	4.44	1 1/4	6 7/8	2 1/2	3
STEB-112312SC	21,000	7.36	1 1/2	9 1/8	3	3 1/2

Safety Factor 5:1

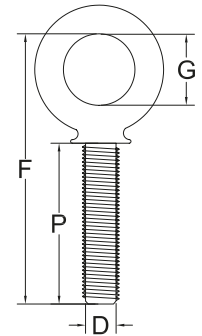

UNC threads

Shoulder Type Machinery Eye Bolts

(zinc plated drop-forged, carbon steel quenched and tempered)

Code	Working Load Limit lbs.	Weight / ea. lbs.	Dimensions in.			
			D	F	G	P
STEB-014001	500	0.05	1/4	2 1/8	3/4	1
STEB-516118	900	0.10	5/16	2 1/2	7/8	1 1/8
STEB-038114	1,300	0.16	3/8	2 15/16	1	1 1/4
STEB-012112	2,400	0.35	1/2	3 1/4	1 1/8	1 1/2
STEB-058134	4,000	0.67	5/8	4 1/8	1 1/4	1 3/4
STEB-034002	5,000	1.00	3/4	4 3/8	1 1/2	2
STEB-078214	7,000	1.63	7/8	5 1/8	1 3/4	2 1/4
STEB-001212	9,000	2.22	1	5 7/8	2	2 1/2
STEB-114003	15,000	4.44	1 1/4	6 7/8	2 1/2	3
STEB-112312	21,000	7.36	1 1/2	9 1/8	3	3 1/2

Safety Factor 5:1

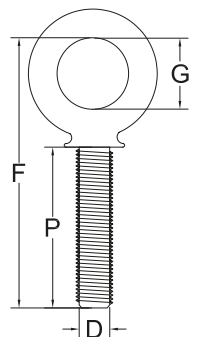

UNC threads



Regular Nut Eye Bolts

(hot dip galvanized, drop-forged, carbon steel quenched and tempered)

Code	Working Load Limit lbs.	Weight / ea. lbs.	Dimensions in.				
			D	F	G	P	Q
RNEB-014002	500	0.08	1/4	2 3/4	1/2	1 1/2	2
RNEB-014004	500	0.12	1/4	4 3/4	1/2	2 1/2	4
RNEB-516214	800	0.13	5/16	3 1/4	5/8	1 1/2	2 1/4
RNEB-516414	800	0.25	5/16	5 1/4	5/8	2 1/2	4 1/4
RNEB-038212	1,200	0.24	3/8	3 3/4	3/4	1 1/2	2 1/2
RNEB-038412	1,200	0.29	3/8	5 3/4	3/4	2 1/2	4 1/2
RNEB-038006	1,200	0.35	3/8	7 1/4	3/4	2 1/2	6
RNEB-012314	2,200	0.50	1/2	4 7/8	1	1 1/2	3 1/4
RNEB-012006	2,200	0.66	1/2	7 5/8	1	3	6
RNEB-012008	2,200	0.82	1/2	9 5/8	1	3	8
RNEB-012010	2,200	0.88	1/2	11 5/8	1	3	10
RNEB-012012	2,200	1.15	1/2	13 5/8	1	3	12
RNEB-058004	3,500	1.03	5/8	6	1 1/4	2	4
RNEB-058006	3,500	1.20	5/8	8	1 1/4	3	6
RNEB-058008	3,500	1.35	5/8	10	1 1/4	3	8
RNEB-058010	3,500	1.53	5/8	12	1 1/4	3	10
RNEB-058012	3,500	1.67	5/8	14	1 1/4	4	12
RNEB-034412	5,200	1.68	3/4	7	1 1/2	2	4 1/2
RNEB-034006	5,200	1.85	3/4	8 1/2	1 1/2	3	6
RNEB-034008	5,200	2.08	3/4	10 1/2	1 1/2	3	8
RNEB-034010	5,200	2.37	3/4	12 1/2	1 1/2	3	10
RNEB-034012	5,200	2.58	3/4	14 1/2	1 1/2	4	12
RNEB-034015	5,200	3.00	3/4	17 1/2	1 1/2	5	15
RNEB-078005	7,200	2.70	7/8	7 7/8	1 3/4	2 1/2	5
RNEB-078008	7,200	3.10	7/8	10 7/8	1 3/4	4	8
RNEB-078012	7,200	4.00	7/8	14 7/8	1 3/4	4	12
RNEB-001006	10,000	4.25	1	9 1/4	2	3	6
RNEB-001009	10,000	4.70	1	12 1/4	2	4	9
RNEB-001012	10,000	5.40	1	15 1/4	2	4	12
RNEB-001018	10,000	6.50	1	21 1/4	2	7	18
RNEB-114008	15,200	7.50	1 1/4	12 1/8	2 1/2	4	8
RNEB-114012	15,200	9.00	1 1/4	16 1/8	2 1/2	4	12
RNEB-114020	15,200	12.1	1 1/4	24 1/8	2 1/2	6	20

Safety Factor 5:1

Eye Nuts

(hot dip galvanized, drop-forged, forged carbon steel, quenched and tempered)

Code	Thread size in.	Working Load Limit lbs.	Weight / ea. lbs.	Dimensions in.			
				A	B	D	E
EN-014	1/4 - 20	520	0.09	0.690	0.750	0.250	1.690
EN-516	5/16 - 18	700	0.11	0.690	0.750	0.250	1.690
EN-038	3/8 - 16	1,250	0.18	1.250	1.000	0.312	2.062
EN-012	1/2 - 13	2,250	0.28	1.500	1.250	0.375	2.500
EN-058	5/8 - 11	3,600	0.58	2.000	1.500	0.500	3.187
EN-034	3/4 - 10	5,200	1.00	2.375	1.750	0.625	3.875
EN-078	7/8 - 9	7,200	1.70	2.625	2.000	0.750	4.312
EN-001	1	10,000	2.75	3.065	2.155	0.910	5.050
EN-114	1 1/4	15,500	3.87	3.501	2.420	1.042	5.710
EN-112	1 1/2	22,500	6.78	4.31	3.12	1.25	7.06

Safety Factor 5:1

Also available in stainless steel. Other dimensions available upon request.

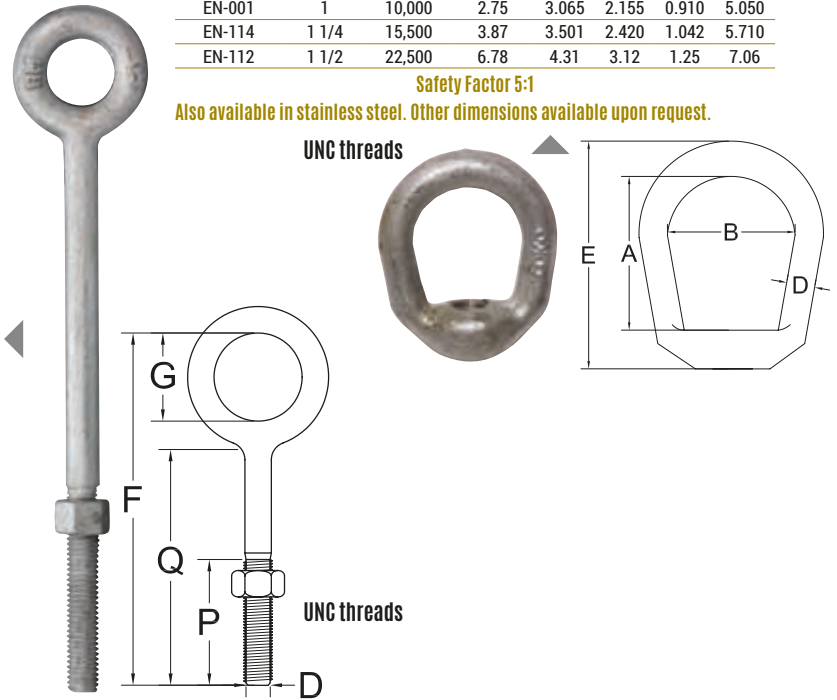

Eye & Eye Swivels

(forged steel hot dip galvanized)

Code	Diameter in.	Working Load Limit lbs.	Weight / ea. lbs.	Dimensions in.	
				B	F
G402-014	1/4	850	0.21	3/4	2 15/16
G402-516	5/16	1,250	0.39	1	3 9/16
G402-038	3/8	2,250	0.75	1 1/4	4 5/16
G402-012	1/2	3,600	1.43	1 1/2	5 7/16
G402-058	5/8	5,200	2.50	1 3/4	6 9/16
G402-034	3/4	7,200	4.13	2	7 3/16
G402-078	7/8	10,000	6.25	2 1/4	8 3/8
G402-001	1	12,500	9.00	2 1/2	9 5/8
G402-114	1 1/4	18,000	15.75	3 1/8	11 1/8
G402-112	1 1/2	45,200	54.75	4	17 1/8

Safety Factor 5:1

Federal Specification : RR-C-271G-16

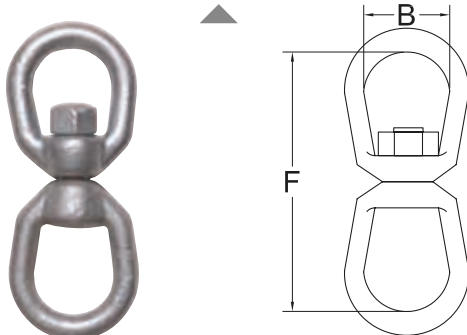

Jaw & Eye Swivels

(forged steel hot dip galvanized)

Code	Diameter in.	Working Load Limit lbs.	Weight / ea. lbs.	Dimensions in.		
				B	F	H
G403-014	1/4	850	0.25	3/4	2 5/8	15/32
G403-516	5/16	1,250	0.37	1	2 15/16	1/2
G403-038	3/8	2,250	0.70	1 1/4	3 5/8	5/8
G403-012	1/2	3,600	1.43	1 1/2	4 1/2	3/4
G403-058	5/8	5,200	2.48	1 3/4	5 5/16	15/16
G403-034	3/4	7,200	3.88	2	6 1/16	1 1/8
G403-078	7/8	10,000	5.75	2 1/4	7	1 3/16
G403-001	1	12,500	10.25	2 1/2	8 9/16	1 3/4
G403-114	1 1/4	18,000	15.75	3 1/8	9 7/16	2 1/16

Safety Factor 5:1

Federal Specification : RR-C-271D

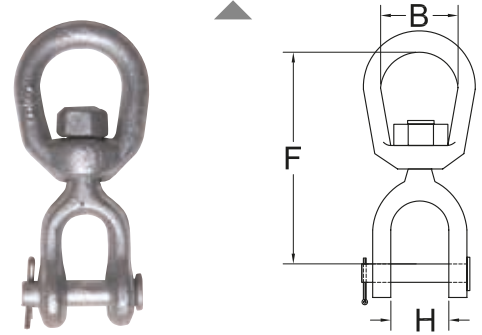

Hot Dip Galvanized Turnbuckles (JAW & JAW), drop-forged

Code	Thread Dia. x Take-Up in.	Working Load Limit lbs.	Weight / ea. lbs.	Dimensions in.					
				F Open	F Closed	H	I	U Closed	W
TJJG-01404	1/4 x 4	500	0.36	10.90	6.90	.45	.62	1.58	4.00
TJJG-516412	5/16 x 4 1/2	800	0.52	12.36	8.36	.50	.87	1.98	4.50
TJJG-03806	3/8 x 6	1,200	0.93	16.14	10.14	.54	.87	2.12	6.00
TJJG-01206	1/2 x 6	2,200	1.68	18.50	11.50	.65	1.06	2.75	6.00
TJJG-01209	1/2 x 9	2,200	1.85	24.50	14.50	.65	1.06	2.75	9.00
TJJG-01212	1/2 x 12	2,200	2.20	30.50	17.50	.65	1.06	2.75	12.00
TJJG-05806	5/8 x 6	3,500	2.82	20.05	12.80	.79	1.31	3.50	6.00
TJJG-05809	5/8 x 9	3,500	3.25	26.05	15.80	.79	1.31	3.50	9.00
TJJG-05812	5/8 x 12	3,500	3.75	32.05	18.80	.79	1.31	3.50	12.00
TJJG-03406	3/4 x 6	5,200	4.68	21.50	14.00	.94	1.50	4.18	6.00
TJJG-03409	3/4 x 9	5,200	5.36	27.50	17.00	.94	1.50	4.18	9.00
TJJG-03412	3/4 x 12	5,200	6.12	33.50	20.00	.94	1.50	4.18	12.00
TJJG-03418	3/4 x 18	5,200	7.75	45.50	26.00	.94	1.50	4.18	18.00
TJJG-07812	7/8 x 12	7,200	9.38	35.11	21.36	1.13	1.75	4.85	12.00
TJJG-07818	7/8 x 18	7,200	11.44	47.11	27.36	1.13	1.75	4.85	18.00
TJJG-00106	1 x 6	10,000	10.20	24.72	16.72	1.34	2.06	5.53	6.00

Safety Factor 5:1

Federal Specification : FF-T-791B Other dimensions available upon request.

Forged jaw ends are fitted with bolts and nuts for 1/4" through 5/8", and cotter pin on 3/4" through 2 3/4" sizes.

UNC Threading.

End fittings are quenched and tempered.

Body is heat treated by normalizing.

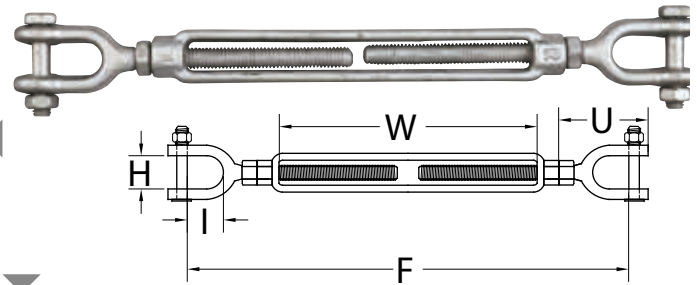

Code	Thread Dia. x Take-Up in.	Working Load Limit lbs.	Weight / ea. lbs.	Dimensions in.					
				F Open	F Closed	H	I	U Closed	W
TJJG-00112	1 x 12	10,000	12.88	36.72	22.72	1.34	2.06	5.53	12.00
TJJG-00118	1 x 18	10,000	16.10	48.72	28.72	1.34	2.06	5.53	18.00
TJJG-00124	1 x 24	10,000	18.60	60.72	34.72	1.34	2.06	5.53	24.00
TJJG-11412	1 1/4 x 12	15,200	23.60	39.84	25.34	1.75	2.81	7.21	12.00
TJJG-11418	1 1/4 x 18	15,200	26.60	51.84	31.34	1.75	2.81	7.21	18.00
TJJG-11424	1 1/4 x 24	15,200	29.00	63.84	37.34	1.75	2.81	7.21	24.00
TJJG-11212	1 1/2 x 12	21,400	35.50	41.50	26.50	2.06	2.81	7.88	12.00
TJJG-11218	1 1/2 x 18	21,400	40.70	53.50	32.50	2.06	2.81	7.88	18.00
TJJG-11224	1 1/2 x 24	21,400	47.60	65.50	38.50	2.06	2.81	7.88	24.00
TJJG-13418	1 3/4 x 18	28,000	52.40	53.38	35.38	2.60	3.38	9.40	18.00
TJJG-13424	1 3/4 x 24	28,000	64.00	65.38	41.38	2.60	3.38	9.40	24.00
TJJG-00224	2 x 24	37,000	94.00	69.54	45.54	2.62	3.69	11.86	24.00
TJJG-21224	2 1/2 x 24	60,000	175.00	72.98	48.98	3.06	4.44	13.56	24.00
TJJG-23424	2 3/4 x 24	75,000	248.00	74.75	50.75	3.63	4.19	15.22	24.00

Safety Factor 5:1

Hot Dip Galvanized Turnbuckles (JAW & EYE), drop-forged

Code	Thread Dia. x Take-Up in.	Working Load Limit lbs.	Weight / ea. lbs.	Dimensions in.								
				A	B	F Open	F Closed	H	I	U Closed	V Closed	W
TJEG-01404	1/4 x 4	500	.30	.78	.34	11.35	7.35	.45	.62	1.58	1.75	4.00
TJEG-516412	5/16 x 4 1/2	800	.50	.94	.44	13.71	8.71	.50	.87	1.98	2.09	4.50
TJEG-03806	3/8 x 6	1,200	.80	1.12	.53	16.81	10.81	.54	.87	2.12	2.52	6.00
TJEG-01206	1/2 x 6	2,200	1.51	1.44	.72	19.29	12.29	.65	1.06	2.75	3.23	6.00
TJEG-01209	1/2 x 9	2,200	1.71	1.44	.72	25.29	15.29	.65	1.06	2.75	3.23	9.00
TJEG-01212	1/2 x 12	2,200	2.08	1.44	.72	31.29	18.29	.65	1.06	2.75	3.23	12.00
TJEG-05806	5/8 x 6	3,500	2.35	1.75	.88	20.99	13.74	.79	1.31	3.50	3.90	6.00
TJEG-05809	5/8 x 9	3,500	3.17	1.75	.88	26.99	16.74	.79	1.31	3.50	3.90	9.00
TJEG-05812	5/8 x 12	3,500	3.61	1.75	.88	32.99	19.74	.79	1.31	3.50	3.90	12.00
TJEG-03406	3/4 x 6	5,200	4.00	2.09	1.00	22.69	15.19	.94	1.50	4.18	4.69	6.00
TJEG-03409	3/4 x 9	5,200	4.75	2.09	1.00	28.69	18.19	.94	1.50	4.18	4.69	9.00
TJEG-03412	3/4 x 12	5,200	5.93	2.09	1.00	34.69	21.19	.94	1.50	4.18	4.69	12.00
TJEG-03418	3/4 x 18	5,200	7.00	2.09	1.00	46.69	27.19	.94	1.50	4.18	4.69	18.00
TJEG-07812	7/8 x 12	7,200	8.36	2.38	1.25	36.09	22.34	1.13	1.75	4.85	5.10	12.00
TJEG-07818	7/8 x 18	7,200	9.75	2.38	1.25	48.09	28.34	1.13	1.75	4.85	5.10	18.00
TJEG-00106	1 x 6	10,000	8.92	3.00	1.44	26.34	18.34	1.34	2.06	5.53	6.36	6.00
TJEG-00112	1 x 12	10,000	11.20	3.00	1.44	38.34	24.34	1.34	2.06	5.53	6.36	12.00
TJEG-00118	1 x 18	10,000	13.30	3.00	1.44	50.34	30.34	1.34	2.06	5.53	6.36	18.00
TJEG-00124	1 x 24	10,000	17.00	3.00	1.44	62.34	36.34	1.34	2.06	5.53	6.36	24.00
TJEG-11412	1 1/4 x 12	15,200	19.42	3.56	1.81	41.32	26.82	1.75	2.81	7.21	7.72	12.00
TJEG-11418	1 1/4 x 18	15,200	24.18	3.56	1.81	53.32	32.82	1.75	2.81	7.21	7.72	18.00
TJEG-11424	1 1/4 x 24	15,200	28.50	3.56	1.81	65.32	38.82	1.75	2.81	7.21	7.72	24.00
TJEG-11212	1 1/2 x 12	21,400	28.99	4.06	2.12	43.50	28.50	2.06	2.81	7.88	8.62	12.00
TJEG-11218	1 1/2 x 18	21,400	35.00	4.06	2.12	55.50	34.50	2.06	2.81	7.88	8.62	18.00
TJEG-11224	1 1/2 x 24	21,400	39.18	4.06	2.12	67.50	40.50	2.06	2.91	7.88	8.62	24.00
TJEG-13418	1 3/4 x 18	28,000	53.75	4.62	2.38	53.38	37.38	2.60	3.38	9.40	10.00	18.00
TJEG-13424	1 3/4 x 24	28,000	60.68	4.62	2.38	67.38	43.38	2.60	3.38	9.40	10.00	24.00
TJEG-00224	2 x 24	37,000	89.00	5.75	2.69	72.62	48.62	2.62	3.69	11.86	11.86	24.00
TJEG-21224	2 1/2 x 24	60,000	165.00	6.50	3.12	75.80	51.80	3.06	4.44	13.56	13.78	24.00
TJEG-23424	2 3/4 x 24	75,000	183.00	7.00	3.25	77.88	53.88	3.68	4.19	15.22	15.22	24.00

Safety Factor 5:1

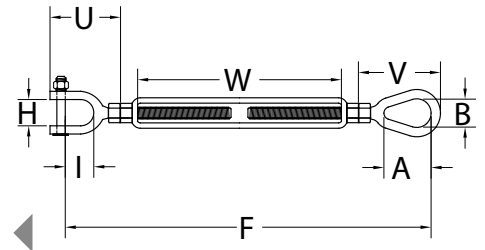

Federal Specification : FF-T-791B

Other dimensions available upon request.

Forged jaw ends are fitted with bolts and nuts for 1/4" through 5/8", and cotter pin on 3/4" through 2 3/4" sizes.

UNC Threading.

End fittings are quenched and tempered.

Body is heat treated by normalizing.

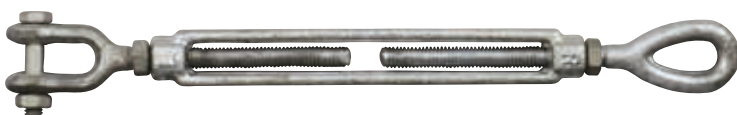



Hot Dip Galvanized Turnbuckles (EYE & EYE), drop-forged

Code	Thread Dia. x Take-Up in.	Working Load Limit lbs.	Weight / ea. lbs.	Dimensions in.					
				A	B	F Open	F Closed	U Closed	W
TEEG-01404	1/4 x 4	500	0.26	.78	.34	11.80	7.80	1.75	4.00
TEEG-516412	5/16 x 4 1/2	800	0.45	.94	.44	13.56	9.06	2.09	4.50
TEEG-03806	3/8 x 6	1,200	0.75	1.12	.53	17.47	11.47	2.52	6.00
TEEG-01206	1/2 x 6	2,200	1.50	1.44	.72	20.08	13.08	3.23	6.00
TEEG-01209	1/2 x 9	2,200	1.75	1.44	.72	26.08	16.08	3.23	9.00
TEEG-01212	1/2 x 12	2,200	2.18	1.44	.72	32.08	19.08	3.23	12.00
TEEG-05806	5/8 x 6	3,500	2.63	1.75	.88	21.93	14.68	3.90	6.00
TEEG-05809	5/8 x 9	3,500	3.00	1.75	.88	27.93	17.68	3.90	9.00
TEEG-05812	5/8 x 12	3,500	3.25	1.75	.88	33.93	20.68	3.90	12.00
TEEG-03406	3/4 x 6	5,200	3.75	2.09	1.00	23.88	16.38	4.69	6.00
TEEG-03409	3/4 x 9	5,200	4.50	2.09	1.00	29.88	19.38	4.69	9.00
TEEG-03412	3/4 x 12	5,200	5.75	2.09	1.00	35.88	22.38	4.69	12.00
TEEG-03418	3/4 x 18	5,200	7.00	2.09	1.00	47.88	28.38	4.69	18.00
TEEG-07812	7/8 x 12	7,200	8.35	2.38	1.25	37.07	23.32	5.10	12.00
TEEG-07818	7/8 x 18	7,200	10.25	2.38	1.25	49.07	29.32	5.10	18.00
TEEG-00106	1 x 6	10,000	9.04	3.00	1.44	27.97	19.97	6.36	6.00

Safety Factor 5:1

Federal Specification : FF-T-791B Other dimensions available upon request.
UNC Threading.

End fittings are quenched and tempered.
Body is heat treated by normalizing.

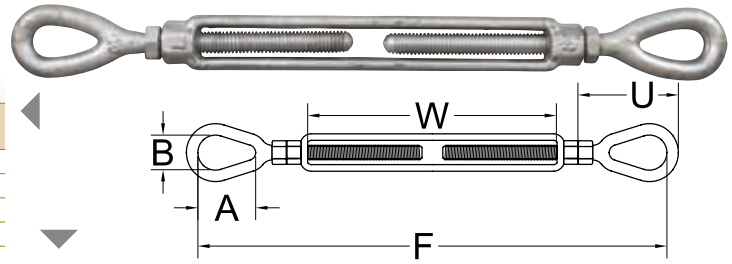

Code	Thread Dia. x Take-Up in.	Working Load Limit lbs.	Weight / ea. lbs.	Dimensions in.					
				A	B	F Open	F Closed	U Closed	W
TEEG-00112	1 x 12	10,000	11.25	3.00	1.44	39.97	25.97	6.36	12.00
TEEG-00118	1 x 18	10,000	14.0	3.00	1.44	51.97	31.97	6.36	18.00
TEEG-00124	1 x 24	10,000	17.0	3.00	1.44	63.97	37.97	6.36	24.00
TEEG-11412	1 1/4 x 12	15,200	19.0	3.56	1.81	42.81	28.31	7.72	12.00
TEEG-11418	1 1/4 x 18	15,200	24.1	3.56	1.81	54.81	34.31	7.72	18.00
TEEG-11424	1 1/4 x 24	15,200	27.0	3.56	1.81	66.81	40.31	7.72	24.00
TEEG-11212	1 1/2 x 12	21,400	27.0	4.06	2.12	45.50	30.50	8.62	12.00
TEEG-11218	1 1/2 x 18	21,400	31.2	4.06	2.12	57.50	36.50	8.62	18.00
TEEG-11224	1 1/2 x 24	21,400	38.2	4.06	2.12	69.50	42.50	8.62	24.00
TEEG-13418	1 3/4 x 18	28,000	45.0	4.62	2.38	57.38	39.38	10.00	18.00
TEEG-13424	1 3/4 x 24	28,000	58.0	4.62	2.38	69.38	45.38	10.00	24.00
TEEG-00224	2 x 24	37,000	85.0	5.75	2.69	75.69	51.69	13.09	24.00
TEEG-21224	2 1/2 x 24	60,000	148.0	6.50	3.12	78.62	54.62	13.78	24.00
TEEG-23424	2 3/4 x 24	75,000	180.0	7.00	3.25	81.00	57.00	15.22	24.00

Safety Factor 5:1

Hot Dip Galvanized Turnbuckles (HOOK & HOOK), drop-forged

Code	Thread Dia. x Take-Up in.	Working Load Limit lbs.	Weight / ea. lbs.	Dimensions in.					
				C	F Open	F Closed	H	U Closed	W
THHG-01404	1/4 x 4	400	0.26	1.27	11.12	7.12	.45	1.59	4.00
THHG-516412	5/16 x 4 1/2	700	0.45	1.50	12.81	8.31	.50	1.94	4.50
THHG-03806	3/8 x 6	1,000	0.75	1.77	16.50	10.50	.56	2.30	6.00
THHG-01206	1/2 x 6	1,500	1.50	2.28	18.82	11.82	.66	2.94	6.00
THHG-01209	1/2 x 9	1,500	1.75	2.28	24.82	14.82	.66	2.94	9.00
THHG-01212	1/2 x 12	1,500	2.18	2.28	30.82	17.82	.66	2.94	12.00
THHG-05806	5/8 x 6	2,250	2.63	2.81	20.50	13.25	.90	3.69	6.00
THHG-05809	5/8 x 9	2,250	3.00	2.81	26.50	16.25	.90	3.69	9.00
THHG-05812	5/8 x 12	2,250	3.25	2.81	32.50	19.25	.90	3.69	12.00
THHG-03406	3/4 x 6	3,000	3.75	3.33	22.38	14.88	.98	4.52	6.00
THHG-03409	3/4 x 9	3,000	4.50	3.33	28.38	17.88	.98	4.52	9.00
THHG-03412	3/4 x 12	3,000	5.75	3.33	34.38	20.88	.98	4.52	12.00
THHG-03418	3/4 x 18	3,000	7.00	3.33	46.38	26.88	.98	4.52	18.00
THHG-07812	7/8 x 12	4,000	8.35	3.78	36.00	22.25	1.13	5.19	12.00

Safety Factor 5:1

Federal Specification : FF-T-791B Other dimensions available upon request.
UNC Threading.

End fittings are quenched and tempered.
Body is heat treated by normalizing.

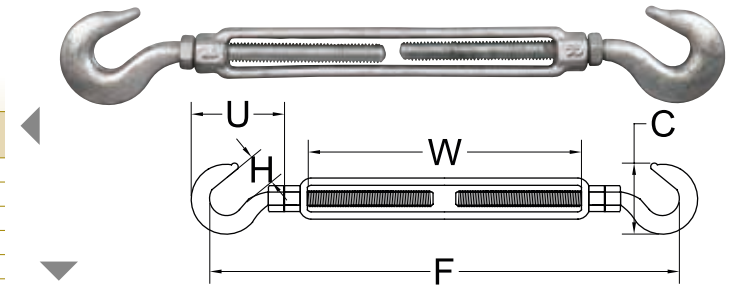

Code	Thread Dia. x Take-Up in.	Working Load Limit lbs.	Weight / ea. lbs.	Dimensions in.					
				C	F Open	F Closed	H	U Closed	W
THHG-07818	7/8 x 18	4,000	10.25	3.78	48.00	28.25	1.13	5.19	18.00
THHG-00106	1 x 6	5,000	9.04	4.25	25.63	17.63	1.25	5.84	6.00
THHG-00112	1 x 12	5,000	11.25	4.25	37.63	23.63	1.25	5.84	12.00
THHG-00118	1 x 18	5,000	14.0	4.25	49.63	29.63	1.25	5.84	18.00
THHG-00124	1 x 24	5,000	17.0	4.25	61.63	35.63	1.25	5.84	24.00
THHG-11412	1 1/4 x 12	6,500	19.0	5.13	40.50	26.50	1.50	7.22	12.00
THHG-11418	1 1/4 x 18	6,500	24.1	5.13	52.50	32.50	1.50	7.22	18.00
THHG-11424	1 1/4 x 24	6,500	27.0	5.13	64.50	38.50	1.50	7.22	24.00
THHG-11212	1 1/2 x 12	7,500	27.0	5.75	43.50	30.50	1.88	8.34	12.00
THHG-11218	1 1/2 x 18	7,500	31.2	5.75	55.50	36.50	1.88	8.34	18.00
THHG-11224	1 1/2 x 24	7,500	38.2	5.75	67.50	42.50	1.88	8.34	24.00

Safety Factor 5:1

Stub end Turnbuckles, self colored, drop forged

Code	Thread Dia. x Take-Up in.	Working Load Limit lbs.	Weight / ea. lbs.	Dimensions in.			
				E	F	U	W
TSE-03806	3/8 x 6	1,200	0.75	7.13	16.0	4.44	6.0
TSE-01206	1/2 x 6	2,200	1.25	7.50	16.0	4.25	6.0
TSE-01209	1/2 x 9	2,200	1.70	10.50	19.0	4.25	9.0
TSE-05806	5/8 x 6	3,500	2.11	7.88	16.0	4.06	6.0
TSE-03406	3/4 x 6	5,200	3.27	8.25	17.0	4.38	6.0
TSE-03409	3/4 x 9	5,200	3.90	11.25	20.0	4.38	9.0
TSE-03412	3/4 x 12	5,200	4.60	14.25	23.0	4.38	12.0
TSE-07806	7/8 x 6	7,200	4.78	8.63	18.0	4.69	6.0
TSE-00106	1 x 6	10,000	6.36	9.00	19.0	5.00	6.0
TSE-00112	1 x 12	10,000	8.80	15.00	25.0	5.00	12.0
TSE-11806	1 1/8 x 6	12,400	8.88	9.13	19.0	4.94	6.0
TSE-11406	1 1/4 x 6	15,200	10.18	9.13	20.0	5.44	6.0
TSE-11412	1 1/4 x 12	15,200	13.60	15.12	26.0	5.44	12.0
TSE-11206	1 1/2 x 6	21,400	15.30	9.75	20.5	5.38	6.0
TSE-11212	1 1/2 x 12	21,400	20.44	15.75	26.5	5.38	12.0
TSE-13406	1 3/4 x 6	28,000	30.00	TBD	TBD	TBD	6.0

Safety Factor 5:1

Federal Specification : FF-T-791B

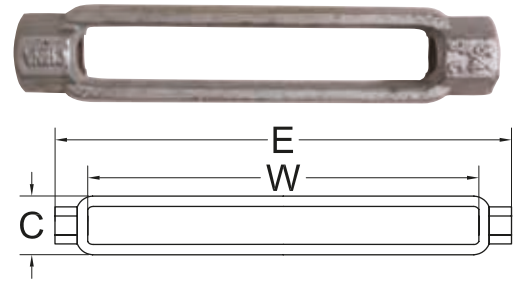
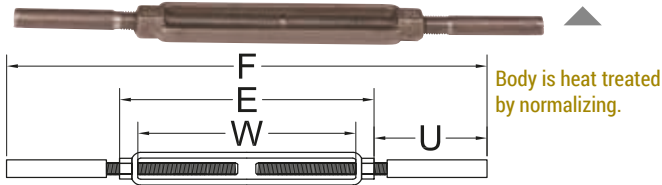

Turnbuckles (body only) Hot Dip Galvanized, drop forged

Code	Thread Dia. x Take-Up in.	Working Load Limit lbs.	Weight / ea. lbs.	Dimensions in.		
				C	E	W
TBG-01404	1/4 x 4	500	0.15	.72	4.75	4.00
TBG-03806	3/8 x 6	1,200	0.29	.88	7.12	6.00
TBG-01206	1/2 x 6	2,200	0.60	1.12	7.50	6.00
TBG-01212	1/2 x 12	2,200	1.00	1.12	13.50	12.00
TBG-05806	5/8 x 6	3,500	0.90	1.38	7.88	6.00
TBG-03406	3/4 x 6	5,200	1.30	1.69	8.25	6.00
TBG-03412	3/4 x 12	5,200	2.08	1.69	14.25	12.00
TBG-00106	1 x 6	10,000	2.48	2.25	9.00	6.00
TBG-00112	1 x 12	10,000	3.93	2.25	15.00	12.00
TBG-11412	1 1/4 x 12	15,200	5.25	2.62	15.12	12.00

Safety Factor 5:1

Federal Specification : FF-T-791B

Other diameters and/or color available upon request.

Zinc Die Cast Ben-Mor Turnbuckles

Code E & H	Thread Dia. x Take-Up in.	Working Load Limit lbs.	Weight / ea. lbs.	Dimensions in.					
				B	F Closed	H	U1 Closed	U2 Closed	W
THEZ-014218	1/4 x 2 1/8	75	0.17	0.425	4.750	0.375	0.375	0.950	2.375
THEZ-516258	5/16 x 2 5/8	150	0.25	0.425	5.750	0.445	0.445	1.300	2.625
THEZ-038003	3/8 x 3	200	0.41	0.500	7.250	0.750	0.750	2.170	3.000

Safety Factor 5:1

Not intended for overhead lifting

UNC Threading

Code E & E	Thread Dia. x Take-Up in.	Working Load Limit lbs.	Weight / ea. lbs.	Dimensions in.			
				B	F Closed	U2 Closed	W
TEEZ-014218	1/4 x 2 1/8	75	0.17	0.425	4.750	0.970	2.375
TEEZ-516258	5/16 x 2 5/8	150	0.25	0.380	6.375	1.580	2.625
TEEZ-038003	3/8 x 3	200	0.41	0.500	7.125	1.800	3.000

Safety Factor 5:1

Not intended for overhead lifting

UNC Threading

Body zinc die cast. End fittings steel zinc plated.

EYE & HOOK

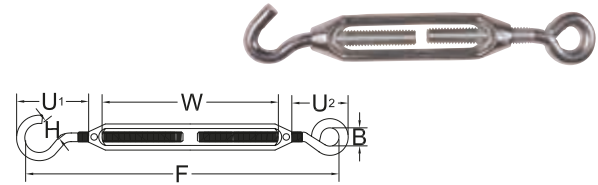

EYE & EYE

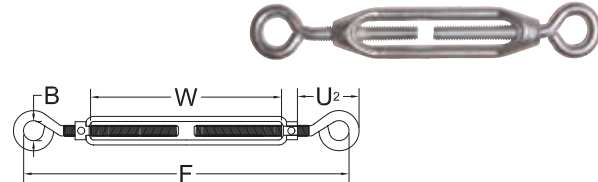

Snap Hooks (zinc plated)

Code	For Chain Dia. in.	Working Load Limit lbs.	Weight / ea. lbs.	Dimensions in.					
				A	C	E	F	G	H
G3315-716	7/16	750	0.23	.27	2.25	3.94	3.36	.75	.68
G3315-916	9/16	1,000	0.48	.34	2.69	4.75	3.84	1.12	.75

Safety Factor 4:1

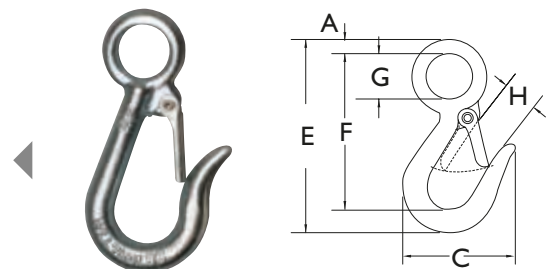

BEN-MOR Hooked on Service



Eye Slip Hooks (Gr. 40 zinc plated, forged steel quenched and tempered)

Code	For Chain Dia. in.	Working Load Limit lbs.	Weight / ea. lbs.	Dimensions in.				
				C	F	G	H	T
ESH40-014	1/4	1,950	0.40	2.75	2.56	.50	.94	.50
ESH40-516	5/16	2,875	0.70	3.06	2.95	.63	1.06	.56
ESH40-038	3/8	4,000	1.00	3.63	3.36	.72	1.31	.66
ESH40-012	1/2	6,900	2.00	4.81	4.28	.94	1.69	.91

Safety Factor 4:1

Not intended for overhead lifting

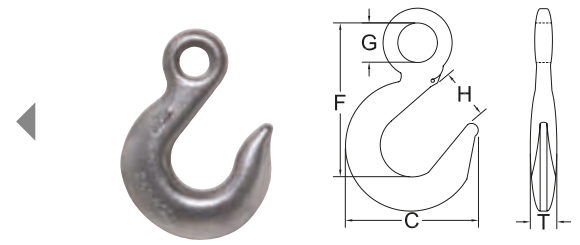

Clevis Slip Hooks (Gr. 40, zinc plated, forged steel quenched and tempered)

Code	For Chain Dia. in.	Working Load Limit lbs.	Weight / ea. lbs.	Dimensions in.						
				B	C	E	F	H	L	T
CSH40-014	1/4	1,950	0.50	.32	2.75	3.95	2.58	.94	.38	.50
CSH40-516	5/16	2,875	0.75	.43	3.06	4.52	2.87	1.06	.44	.56
CSH40-038	3/8	4,000	1.13	.45	3.63	5.15	3.25	1.31	.47	.66
CSH40-716	7/16	5,000	2.06	.59	4.34	5.97	3.70	1.56	.56	.81
CSH40-012	1/2	6,900	2.75	.57	4.81	6.53	4.00	1.69	.63	.91

Safety Factor 4:1

Not intended for overhead lifting

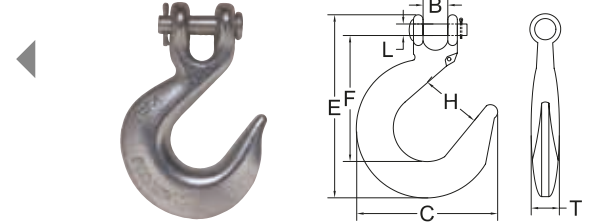

Eye Grab Hooks (Gr. 40 zinc plated, forged steel quenched and tempered)

Code	For Chain Dia. in.	Working Load Limit lbs.	Weight / ea. lbs.	Dimensions in.				
				C	E	F	G	T
EGH40-014	1/4	2,600	0.28	1.81	3.05	1.88	.53	.47
EGH40-516	5/16	3,900	0.45	2.12	3.59	2.28	.62	.59
EGH40-038	3/8	5,400	0.79	2.53	4.28	2.69	.75	.72

Safety Factor 4:1

Not intended for overhead lifting

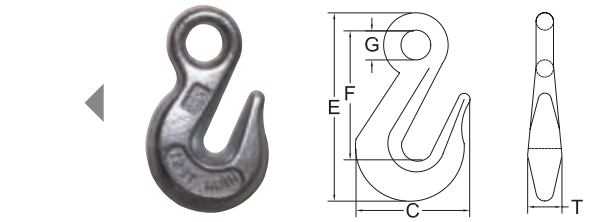

Clevis Grab Hooks (Gr. 40, zinc plated, forged steel quenched and tempered)

Code	For Chain Dia. in.	Working Load Limit lbs.	Weight / ea. lbs.	Dimensions in.						
				B	C	E	F	L	T	
CGH40-014	1/4	2,600	0.38	.32	1.81	3.05	1.64	.31	.47	
CGH40-516	5/16	3,900	0.70	.43	2.12	3.66	2.02	.38	.59	
CGH40-038	3/8	5,400	1.04	.48	2.53	4.42	2.41	.44	.72	
CGH40-716	7/16	7,200	1.31	.66	3.09	4.94	2.75	.56	.69	
CGH40-012	1/2	9,200	2.06	.57	3.56	5.72	3.19	.63	.78	

Safety Factor 4:1

Not intended for overhead lifting

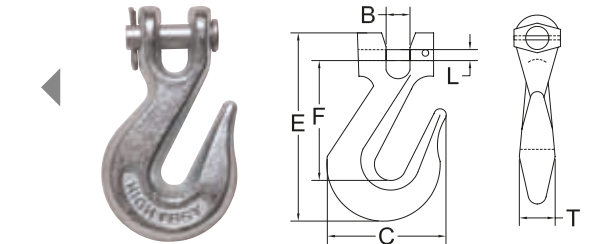

Eye Slip Tow and Lanyard Hooks (zinc plated steel)

Code	Inside Eye Dia. in.	Throat opening in.	Working Load Limit lbs.	Weight / ea. lbs.	Dimensions in.					
					C	E	F	G	H	J
N-318	1.10	2.45	1136	0.7	4.36	8.25	7.19	1.10	2.49	2.12

Safety Factor 5:1

Not intended for overhead lifting

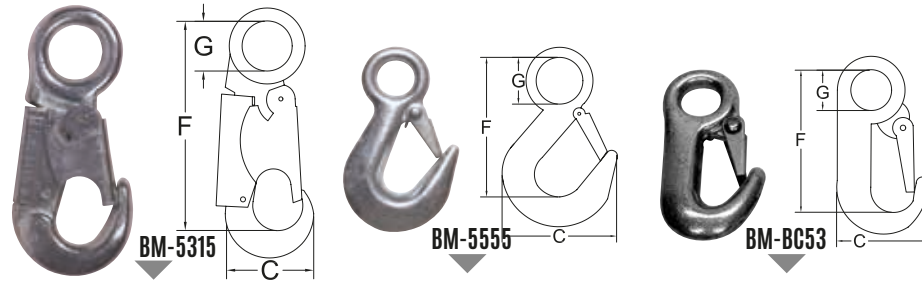
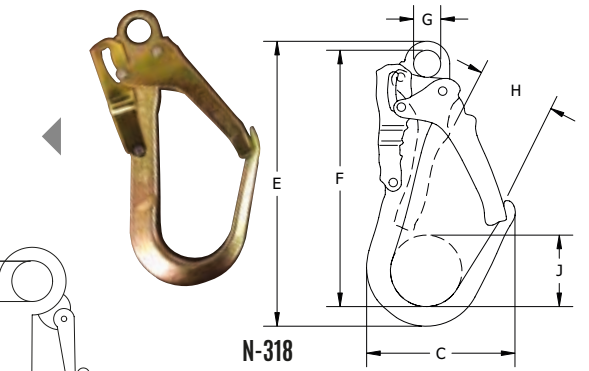

Code	Inside Eye Dia. in.	Throat opening in.	Working Load Limit lbs.	Weight / ea. lbs.	Dimensions in.		
					C	F	G
BM-BC53	3/4	1/2	800	0.33	1.771	2.553	0.75
BM-5555	3/4	5/8	1,500	0.45	2.172	2.827	0.75
BM-5315	1	5/8	1,000	0.61	2.321	4.435	1.00

Safety Factor 5:1

Not intended for overhead lifting



Eye Hooks with latch* (alloy, forged alloy steel, quenched and tempered)

Eye Hooks with latch* (carbon, Forged carbon steel, quenched and tempered)

Code	Working Load Limit TON	Weight / ea. lbs.	Dimensions in.				
			C	D	F	G	H
EH-034	3/4	0.54	2.54	.33	2.80	.63	.81
EH-001	1	0.61	2.83	.36	3.34	.75	.89
EH-112	1 1/2	0.89	3.11	.42	3.81	.91	.91
EH-002	2	1.44	3.53	.55	4.14	1.13	1.00
EH-003	3	2.07	3.97	.58	4.69	1.25	1.09
EH-005	5	4.0	4.5	.72	5.77	1.56	1.52
EH-007	7	8.30	6.27	.90	7.37	2.00	1.61
EH-011	11	15.00	7.45	1.11	9.07	2.44	2.08
EH-015	15	21.60	8.30	1.27	10.08	2.84	2.27

Code	Working Load Limit TON	Weight / ea. lbs.	Dimensions in.				
			C	D	F	G	H
EH-034C	3/4	0.54	2.83	.36	3.34	.75	.89
EH-001C	1	0.61	3.11	.42	3.81	.91	.91
EH-112C	1 1/2	0.89	3.53	.55	4.14	1.13	1.00
EH-002C	2	1.44	3.97	.58	4.69	1.25	1.09
EH-003C	3	2.07	4.81	.72	5.77	1.56	1.36
EH-005C	5	4.0	6.27	.90	7.37	2.00	1.61
EH-007C	7	8.30	7.45	1.11	9.07	2.44	2.08
EH-010C	10	15.00	8.30	1.27	10.08	2.84	2.27
EH-015C	15	21.60	10.30	1.56	12.53	3.50	3.02

Safety Factor 5:1

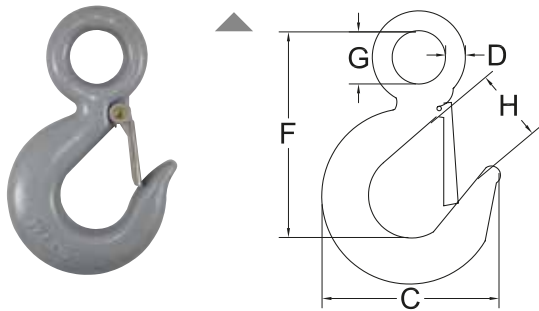

Safety Factor 5:1

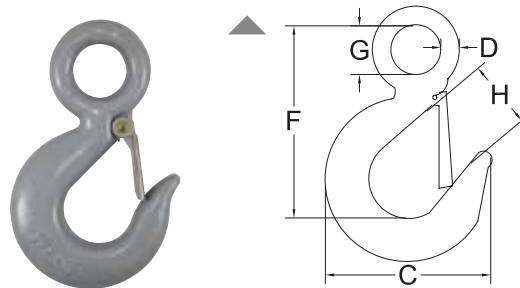

* Lock nut with Nylon insert nut

* Lock nut with Nylon insert nut

Swivel Hooks with latch* (alloy, Forged alloy steel, quenched and tempered)

Swivel Hooks with latch* (carbon, Forged carbon steel, quenched and tempered)

Code	Working Load Limit TON	Weight / ea. lbs.	Dimensions in.				
			B	C	D	F	H
SH-001	1	0.75	1.25	2.86	.38	4.55	.89
SH-112	1 1/2	1.25	1.50	3.15	.50	5.37	.91
SH-002	2	2.25	1.75	3.59	.63	6.12	1.00
SH-003	3	2.30	1.75	4.00	.63	6.50	1.09
SH-005	5	5.00	1.95	4.85	0.80	7.43	1.56
SH-007	7	10.29	2.50	6.28	1.00	9.63	1.61
SH-011	11	16.18	2.75	7.54	1.13	11.37	2.08
SH-015	15	23.25	3.12	8.34	1.25	12.25	2.27

Code	Working Load Limit TON	Weight / ea. lbs.	Dimensions in.				
			B	C	D	F	H
SH-034C	3/4	.75	1.25	2.86	.38	4.55	.89
SH-001C	1	1.25	1.50	3.15	.50	5.37	.91
SH-112C	1 1/2	2.25	1.75	3.59	.63	6.12	1.00
SH-002C	2	2.30	1.75	4.00	.63	6.50	1.09
SH-003C	3	4.96	2.00	4.84	.75	7.50	1.36
SH-005C	5	10.29	2.50	6.28	1.00	9.63	1.61

Safety Factor 5:1

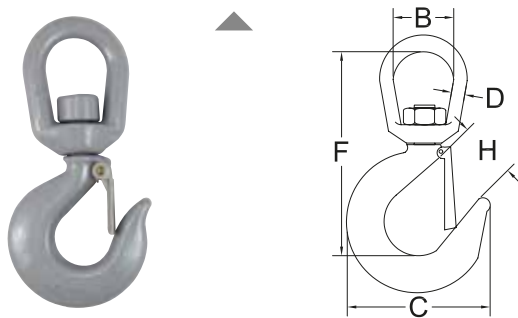

Safety Factor 5:1

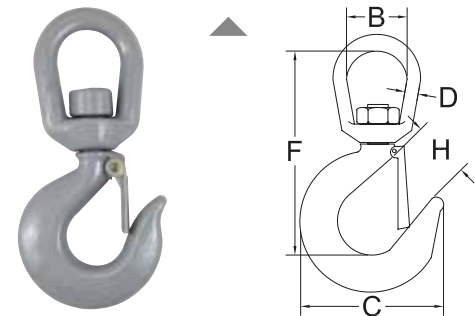

* Lock nut with Nylon insert nut

* Lock nut with Nylon insert nut

Safety Latch Kits (stainless steel)

Code	For Hooks With Capacity Carbon & Alloy TON	Weight / ea. lbs.	Code	For Hooks With Capacity Carbon & Alloy TON	Weight / ea. lbs.
SS4055-012	1/2 & 3/4	0.01	SS4055-003	3 & 5	0.06
SS4055-034	3/4 & 1	0.02	SS4055-005	5 & 7	0.11
SS4055-001	1 & 1 1/2	0.02	SS4055-712	7 1/2 & 11	0.17
SS4055-112	1 1/2 & 2	0.03	SS4055-010	10 & 15	0.17
SS4055-002	2 & 3	0.03			





Snatch Blocks with Alloy Swivel Hook, forged steel

Code	For Cable Diameter in.	Pulley Diameter in.	Working Load Limit TON	Weight / ea. lbs.
K4180-002	3/8	3	2	2
K4180-004	1/2	4 1/2	4	12
K4180-008A	3/4	6	8	27
K4180-008B	3/4	8	8	35
K4180-008C	3/4	10	8	50
K4180-012	7/8	8	12	55
K4180-015	7/8	8	15	58
K4180-020	1 1/8	8	20	103

Safety Factor 4:1



Snatch Blocks with Shackle, forged steel

Code	For Cable Diameter in.	Pulley Diameter in.	Working Load Limit TON	Weight / ea. lbs.
K4190-002	3/8	3	2	2
K4190-004	1/2	4 1/2	4	10
K4190-008A	3/4	6	8	31
K4190-008B	3/4	8	8	36
K4190-008C	3/4	10	8	53
K4190-008D	3/4	14	8	81
K4190-015	7/8	8	15	64
K4190-020	1 1/8	8	20	117

Safety Factor 4:1



Toggle Blocks, forged steel (Tail Board)

Code	For Cable Diameter in.	Pulley Diameter in.	Working Load Limit TON	Weight / ea. lbs.
K4040-002	3/8	3	2	2
K4040-004	1/2	4 1/2	4	7.5
K4040-008A	3/4	6	8	15
K4040-008B	3/4	8	8	25
K4040-015	7/8	8	15	35
K4040-020	1 1/8	8	20	70

Safety Factor 4:1



With a variety of hydraulic swagers and rotary swaging machines, we are capable of swaging 3/64" through 3 1/2" diameter fittings.

With two teams of splicers on two shifts, we manufacture and deliver exactly when needed.

BEN-MOR Hooked on Service



Our Guarantee:

An experienced team available, always ready to deliver your order on time!



Open Spelter Sockets (forged steel, hot dip galvanized)

Code	For Cable Diameter in.	Wirelock required (G416-G417) cm ³	Weight / ea. lbs.	Dimensions in.		
				A	B	L
G416-014	1/4	9	0.90	1.219	11/16	11/16
G416-516	5/16	17	1.30	1.344	13/16	13/16
G416-038	3/8	17	1.30	1.344	13/16	13/16
G416-716	7/16	35	2.30	1.000	1	1
G416-012	1/2	35	2.30	1.000	1	1
G416-916	9/16	52	3.90	1.313	1 1/4	1 3/16
G416-058	5/8	52	3.90	1.313	1 1/4	1 3/16
G416-034	3/4	86	6.00	1.625	1 1/2	1 3/8
G416-078	7/8	125	10.00	1.875	1 3/4	1 5/8
G416-001	1	160	15.50	2.000	2	2
G416-118	1 1/8	210	24.00	2.250	2 1/4	2 1/4
G416-114	1 1/4	350	32.00	2.250	2 1/2	2 1/2
G416-138	1 3/8	350	32.00	2.250	2 1/2	2 1/2
G416-112	1 1/2	420	46.00	3.625	3	2 3/4

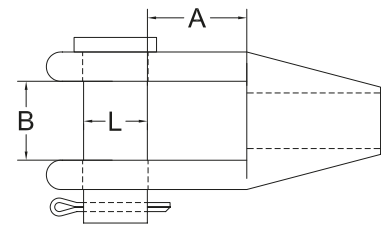

Closed Spelter Sockets (forged steel, hot dip galvanized)

Code	For Cable Diameter in.	Wirelock required (G416-G417) cm ³	Weight / ea. lbs.	Dimensions in.			
				A	B	C	T
G417-014	1/4	9	0.50	2	1 7/16	0.438	0.50
G417-516	5/16	17	1.00	2	1 11/16	0.563	0.69
G417-038	3/8	17	1.00	2	1 11/16	0.563	0.69
G417-716	7/16	35	1.80	2 1/2	2	0.689	0.88
G417-012	1/2	35	1.80	2 1/2	2	0.689	0.88
G417-916	9/16	52	3.40	3	2 5/8	0.813	1.00
G417-058	5/8	52	3.40	3	2 5/8	0.813	1.00
G417-034	3/4	86	5.10	3 1/2	3	1.063	1.25
G417-078	7/8	125	7.80	4	3 5/8	1.313	1.50
G417-001	1	160	12.00	4 1/2	4 1/8	1.438	1.75
G417-118	1 1/8	210	16.00	5	4 1/2	1.563	2.00
G417-114	1 1/4	350	23.00	5 1/2	5	1.689	2.25
G417-138	1 3/8	350	23.00	5 1/2	5	1.689	2.25
G417-112	1 1/2	420	28.00	6	5 3/8	2.00	2.50

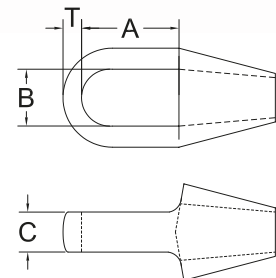



Open Swage Sockets (forged steel)

Code	For Cable Diameter in.	Weight / ea. lbs.	Dimensions in.				
			A	B	D Before swage	D After swage	L
S501-014	1/4	0.57	1.156	11/16	.495	.438	.688
S501-516	5/16	1.24	1.344	13/16	.770	.688	.812
S501-038	3/8	.120	1.344	13/16	.770	.688	.812
S501-716	7/16	2.45	1.500	1	.982	.875	1.00
S501-012	1/2	2.40	1.500	1	.982	.875	1.00
S501-916	9/16	4.80	1.655	1 1/4	1.26	1.13	1.19
S501-058	5/8	4.50	1.655	1 1/4	1.26	1.13	1.19
S501-034	3/4	7.80	2.150	1 1/2	1.55	1.38	1.38
S501-078	7/8	11.80	2.435	1 3/4	1.70	1.50	1.63
S501-001	1	17.80	2.750	2	1.98	1.75	2.00
S501-118	1 1/8	28.90	3.125	2 1/4	2.25	2.00	2.25
S501-114	1 1/4	36.20	3.500	2 1/2	2.53	2.25	2.50
S501-138	1 3/8	47.70	4.000	2 1/2	2.80	2.50	2.50
S501-112	1 1/2	64.40	4.375	3	3.08	2.75	2.75

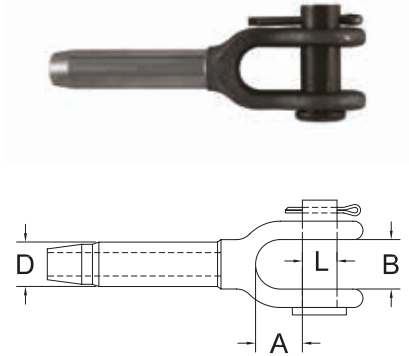

Closed Swage Sockets (forged steel)

Code	For Cable Diameter in.	Weight / ea. lbs.	Dimensions in.				
			C	D Before swage	D After swage	G	T
S502-014	1/4	0.35	1 7/16	.495	.438	.750	1/2
S502-516	5/16	0.77	1 11/16	.770	.688	.875	11/16
S502-038	3/8	0.73	1 11/16	.770	.688	.875	11/16
S502-716	7/16	1.47	2	.982	.875	1.06	7/8
S502-012	1/2	1.38	2	.982	.875	1.06	7/8
S502-916	9/16	2.90	2 1/2	1.26	1.13	1.25	1 1/8
S502-058	5/8	2.80	2 1/2	1.26	1.13	1.25	1 1/8
S502-034	3/4	5.16	3	1.55	1.38	1.44	1 5/16
S502-078	7/8	7.40	3 1/2	1.70	1.50	1.69	1 1/2
S502-001	1	11.20	4	1.98	1.75	2.06	1 3/4
S502-118	1 1/8	16.00	4 1/2	2.25	2.00	2.31	2
S502-114	1 1/4	22.70	5	2.53	2.25	2.56	2 1/4
S502-138	1 3/8	29.00	5 1/4	2.80	2.50	2.56	2 1/4
S502-112	1 1/2	37.50	5 1/2	3.08	2.75	2.81	2 1/2

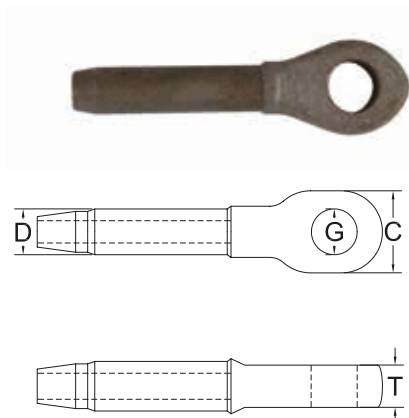

Carbine Snap Hooks with Eyelets

(zinc plated, cold drawn mild steel)

Code	Working Load Limit lbs.	Weight / ea. lbs.	Dimensions in.						
			D		E	F	G	H	
			in.	mm					
S8-1	100	0.04	3/16	5	1.97	1.586	0.197	0.250	
S8-2	140	0.06	1/4	6	2.36	1.894	0.197	0.3125	
S8-3	240	0.15	5/16	8	3.15	2.449	0.315	0.375	
S8-4	400	0.32	3/8	10	3.94	3.071	0.394	0.500	
S8-5	560	0.60	1/2	12	5.51	4.470	0.512	0.8125	

Safety Factor 5:1

Not intended for overhead lifting

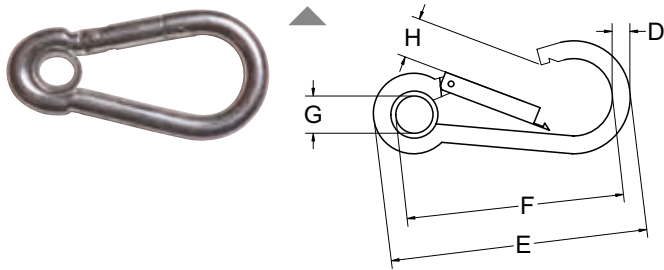

Carbine Snap Hooks

(zinc plated, cold drawn mild steel)

Code	Working Load Limit lbs.	Weight / ea. lbs.	Dimensions in.						
			D		E	F	G	H	
			in.	mm					
S10-1	100	0.04	3/16	5	1.97	1.614	0.197	0.250	
S10-2	140	0.06	1/4	6	2.36	1.949	0.197	0.3125	
S10-3	240	0.15	5/16	8	3.15	2.545	0.315	0.375	
S10-4	400	0.32	3/8	10	3.94	3.199	0.394	0.500	
S10-4.5	485	0.42	7/16	11	4.72	3.960	0.433	0.640	
S10-5	560	0.60	1/2	12	5.51	4.606	0.512	0.8125	

Safety Factor 5:1

Not intended for overhead lifting

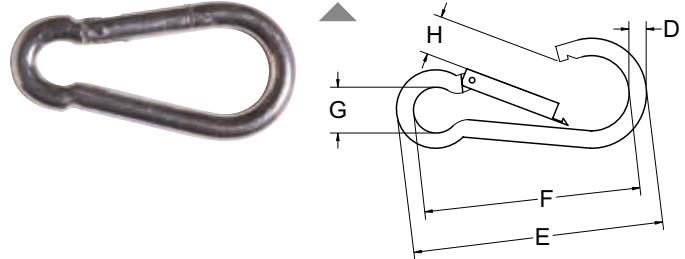

"S" Hooks

(zinc plated, low carbon steel)

Code	Weight / ea. lbs.	Dimensions in.			
		D		F	H
		in.	mm		
SHZ-018	0.01	1/8	3	1.30	0.238
SHZ-532	0.02	5/32	4	1.50	0.191
SHZ-316	0.03	3/16	5	1.44	0.273
SHZ-014	0.07	1/4	6	1.75	0.332
SHZ-516	0.15	5/16	8	2.34	0.497
SHZ-038	0.27	3/8	10	2.75	0.657

Not intended for overhead lifting

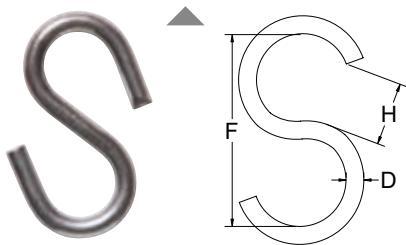

Quick Links Rated and Non-rated

(zinc plated, cold drawn mild steel)

Code Classifié	Code Non-rated	Working Load Limit lbs.	Weight / ea. lbs.	Dimensions in.				
				D		A	B	H
				in.	mm			
QLZ-018	70700	220	0.03	1/8	3	1.00	0.335	0.210
QLZ-316	70701	660	0.06	3/16	5	1.40	0.512	0.242
QLZ-014	70702	880	0.09	1/4	6	1.77	0.571	0.290
QLZ-516	70703	1,760	0.18	5/16	8	2.28	0.689	0.420
QLZ-038	70704	2,640	0.28	3/8	10	2.72	0.808	0.500
QLZ-716	70705	2,900	0.48	7/16	11	3.00	0.870	0.493
QLZ-012	70706	3,300	0.70	1/2	12	3.17	0.925	0.510
QLZ-058	70707	6,000	1.16	5/8	16	4.12	1.065	0.800

Safety Factor 2.5:1

Not intended for overhead lifting

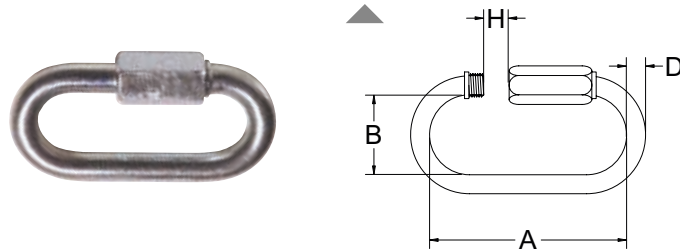

Round Rings

(nickel plated)

Code	Std Pack	Dimensions in.	
		A	D
71000	12	1	3/16
71001	12	1 1/4	3/16
71002	12	1 1/2	1/4
71003	12	2	1/4
71005	12	3/4	11/64

Not intended for overhead lifting

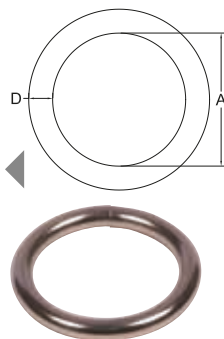

Malleable Swivel

(zinc plated)

Code	For Cable Diameter in.	Working Load Limit lbs.	Weight / ea. lbs.	Dimensions in.			
				B1	B2	D	F
SW316112	3/16	N/D	0.044	.57	.31	.21	1 1/2
SW316134	3/16	N/D	0.044	.57	.31	.21	1 3/4
SW014214	1/4	400	0.11	.71	.43	.23	2 1/4
SW516234	5/16	N/D	0.086	1.00	.48	.32	2 3/4

Safety Factor 5:1

Not intended for overhead lifting

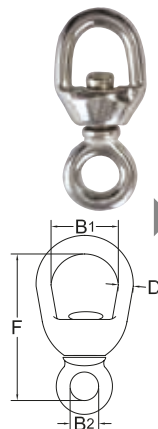



Ben-Mor Single Shank Balls

Code	For Cable Diameter in.	Minimum Breaking Strength lbs.	Material	Dimensions in.				
				C	D	E	I	Z
BM20664C3	3/32	500	Zinc	.285	.187	.650	.168	.477
BM20664C4BAT	1/8	2,000	Zinc plated steel	.375	.252	1.383	.256	1.114
BM20664C6	3/16	3,500	Zinc plated steel	.437	.313	1.444	.997	.435

Not intended for overhead lifting

Plain balls and double shank balls (military specs.) available upon request.

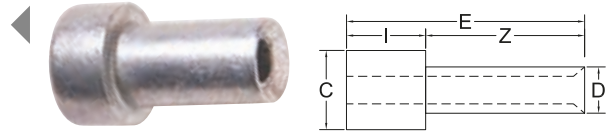

Eye Bolts shoulder-drilled (zinc plated, drop-forged)

Eye Bolts shoulder-drilled (zinc plated, drop-forged)

Code	For Cable Diameter in.	Working Load Limit lbs.	Weight / ea. lbs.	Dimensions in.		
				G	M	P
BM-55830	1/4	1,200	0.35	1	.275	1.7

Safety Factor 5:1 Not intended for overhead lifting

Other dimensions available upon request

See Shoulder Type Machinery Eye Bolt for dimensions (page 22)

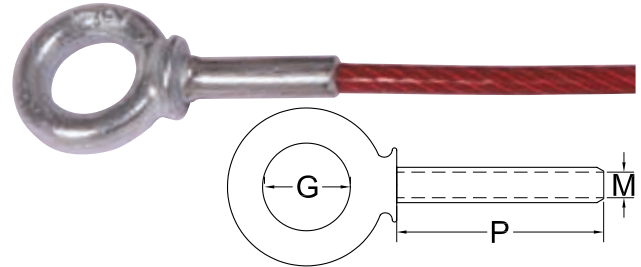

Ben-Mor Threaded Studs (steel)

Code	For Cable Diameter in.	Threads size UNC	Dimensions in.			Finish
			D Before swage	E	P	
BM21259-014F	3/32	1/4 - 20	1/4	2 9/16	1 1/2	ZP
BM21259-014B	1/8	1/4 - 20	1/4	2 1/2	1/2	ZP
BM21259-014C	1/8	1/4 - 20	1/4	2 9/16	1 1/2	ZP
BM21259-014E	1/8	1/4 - 20	1/4	3 3/4	1 1/2	ZP
BM21259-516A	1/8	5/16 - 18	5/16	2 3/4	1 3/4	ZP
BM21259-516B	1/8	5/16 - 18	5/16	4 1/2	3	ZP
BM21259-038A	1/8	3/8 - 16	3/8	3	1 1/2	ZP
BM21259-038B	3/16	3/8 - 16	1/2	3	1 1/2	ZP
BM21259-012A	1/4	1/2 - 13	5/8	4 1/2	2 1/2	ZP
BM21259-058A	5/16	5/8 - 11	3/4	6 1/2	3 1/2	ZP
BM21259-058B	5/16	5/8 - 11	3/4	8	5	ZP
BM21259-058C	3/8	5/8 - 11	7/8	9	6	ZP
BM21259-034A	3/8	3/4 - 10	3/4	8	5	ZP
BM21259-014L	1/8	1/4 - 28	0.250	1.36	3/8	SS
BM21259-038C	1/4	3/8 - 16	0.500	8	5	SS
BM21259-012AB	1/4	1/2 - 13	0.625	6	4	SS
BM21259-012AK	3/8	1/2 - 13	0.700	5.775	1	ZP
BM21259-058AG	5/16	5/8 - 11	0.750	3 1/2	1	SS
BM21259-034X	3/8	3/4 - 10	0.750	13 5/8	5 1/4	Acier
BM21259-034Y	3/8	3/4 - 10	0.750	5 1/8	1 5/8	Acier

Available on request : Stainless steel, Left-Hand thread, metric thread, fine thread.

Custom made for cables up to 1 1/2". Other dimensions available upon request.

Available in self colored or zinc plated.

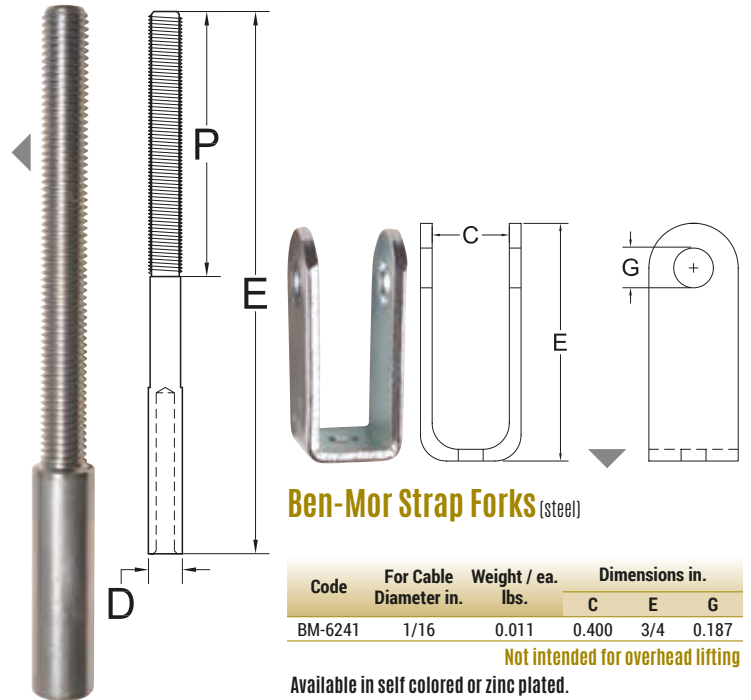

Ben-Mor Strap Forks (steel)

Code	For Cable Diameter in.	Weight / ea. lbs.	Dimensions in.		
			C	E	G
BM-6241	1/16	0.011	0.400	3/4	0.187

Not intended for overhead lifting

Available in self colored or zinc plated.

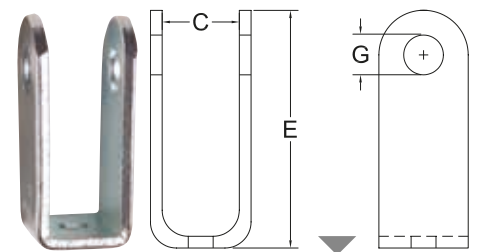

Ben-Mor Forks (steel)

Code	For Cable Diameter in.	Weight / ea. lbs.	Dimensions in.				
			C	D Before swage	D After swage	E	G
BM100-058	3/16	0.2045	3/4	0.501	0.460	2 1/2	0.3125
BM100-031	3/8	0.549	1	0.842	0.775	4 1/2	0.4375
BM100-094	7/16	0.507	1	0.840	0.775	4 1/2	0.4375
BM100-026	3/8	1.069	1	0.840	0.775	7 1/2	0.500

Available in self colored or zinc plated. Custom made for cables up to 1 1/2".

Other dimensions available upon request.

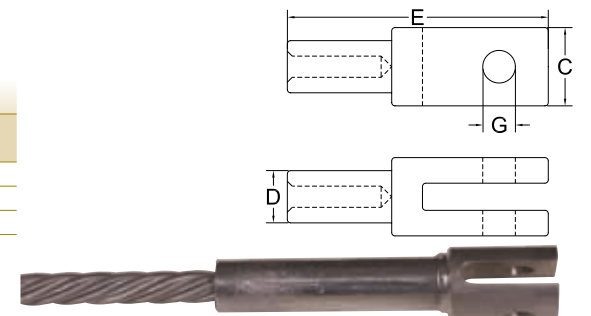

Ben-Mor Eye Ends (steel)

Code	For Cable Diameter in.	Weight / ea. lbs.	Dimensions in.				
			C	D Before swage	D After swage	E	G
BM100-028	3/8	0.875	1	0.838	0.775	6 1/4	0.500

Available in self colored or zinc plated. Other dimensions available upon request.

BEN-MOR Hooked on Service

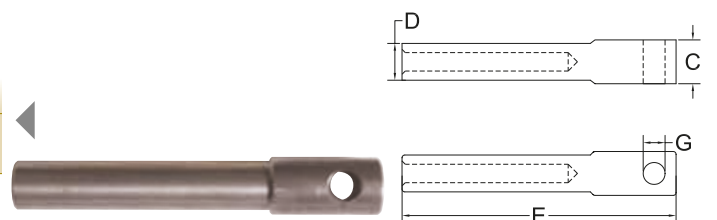



Single Sleeves (stainless steel 304)

Code	For Cable Diameter in.	Weight / each lbs.
BSS505-516	5/16	0.2
BSS505-038	3/8	0.2
BSS505-716	7/16	0.3
BSS505-012	1/2	0.3
BSS505-058	5/8	0.8
BSS505-034	3/4	1
BSS505-078	7/8	1.5
BSS505-001	1	2.2
BSS505-118	1 1/8	2.8
BSS505-114	1 1/4	2.5
BSS505-138	1 3/8	3.5
BSS505-112	1 1/2	3.8
BSS505-134	1 3/4	7
BSS505-002	2	8



Oval Sleeves (Stainless Steel 304)

Code	For Cable Diameter in.	Weight / each approx. lbs.
SSOS-716	7/16	.350
SSOS-012	1/2	.320
SSOS-058	5/8	.600
SSOS-034	3/4	1.00
SSOS-078	7/8	1.50
SSOS-001	1	2.00



Other dimensions available upon request.

Oval Sleeves (Stainless Steel 304)

Code	For Cable Diameter in.	Weight / each approx. lbs.
SSOS-132	1/32	.001
SSOS-364	3/64	.002
SSOS-116	1/16	.002
SSOS-332	3/32	.003
SSOS-018	1/8	.004
SSOS-532	5/32	.014
SSOS-316	3/16	.023
SSOS-732	7/32	.031
SSOS-014	1/4	.044
SSOS-516	5/16	.150
SSOS-038	3/8	.150



Federal Specification MS51844.

Other dimensions available upon request.



Heavy Duty Thimbles (stainless steel 316)

Heavy Duty Code 316	For Cable Diameter in.	Weight / each approx. lbs.	Dimensions in.			
			A	B	H	O
HDTs6FS-316	3/16	0.04	1.35	0.71	0.23	0.05
HDTs6FS-014	1/4	0.08	1.60	0.90	0.28	0.07
HDTs6FS-516	5/16	0.14	1.85	1.08	0.35	0.07
HDTs6FS-038	3/8	0.25	2.00	1.12	0.40	0.11
HDTs6FS-012	1/2	0.53	2.62	1.52	0.55	0.15
HDTs6FS-058	5/8	0.70	3.00	1.78	0.65	0.15
HDTs6FS-034	3/4	1.25	3.83	2.02	0.85	0.22
HDTs6FS-078	7/8	1.50	4.08	2.30	0.95	0.22
HDTs6FS-001	1	2.50	4.80	2.56	1.12	0.22

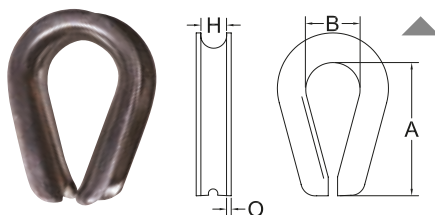

Standard Thimbles (stainless steel 304)

Standard Code 304	For Cable Diameter in.	Weight / each approx. lbs.	Dimensions in.		
			A	B	H
STDTS4-018	1/8	.006	.709	.394	.157
STDTS4-316	3/16	.014	.827	.512	.236
STDTS4-014	1/4	.024	1.063	.591	.276
STDTS4-516	5/16	.056	1.496	.866	.354
STDTS4-038	3/8	.073	1.614	.945	.394
STDTS4-012	1/2	.139	2.080	1.142	.551
STDTS4-058	5/8	.276	2.638	1.574	.709
STDTS4-034	3/4	.588	3.150	1.968	.866
STDTS4-078	7/8	.625	3.543	2.205	.945
STDTS4-001	1	.735	4.724	2.953	1.181

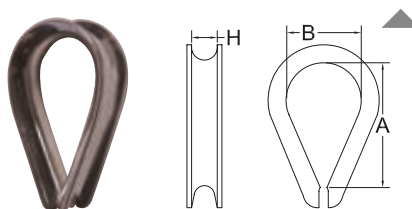

AN Thimbles (stainless steel 304)

Code	For Cable Diameter in.	Weight / each approx. lbs.	Dimensions in.		
			A	B	H
ANTS4-116	3/64 - 1/16 - 5/64	.002	43/64	.350	3/32
ANTS4-018	3/32 - 7/64 - 1/8	.004	45/64	.350	9/64
ANTS4-532	5/32	.006	51/64	.400	11/64
ANTS4-316	3/16	.010	1	.500	13/64
ANTS4-014	7/32 - 1/4	.015	1 13/32	.700	17/64
ANTS4-516	9/32 - 5/16	.035	1 51/64	.900	21/64
ANTS4-038	3/8	.085	2	1.000	25/64





Wire Rope Clips (stainless steel 316)

Code	For Cable Diameter in.	Dimensions in.		Weight / each lbs.
		A	D	
WRCS6-116	1/16	0.620	0.110	0.020
WRCS6-018	1/8	0.810	0.150	0.030
WRCS6-532	5/32	0.810	0.150	0.040
WRCS6-316	3/16	0.960	0.190	0.060
WRCS6-014	1/4	1.490	0.230	0.090
WRCS6-516	5/16	1.315	0.300	0.190
WRCS6-038	3/8	1.855	0.385	0.370
WRCS6-012	1/2	1.965	0.460	0.596
WRCS6-916	9/16	2.630	0.540	0.850
WRCS6-058	5/8	2.630	0.540	1.000
WRCS6-034	3/4	2.730	0.540	1.500
WRCS6-078	7/8	3.000	0.770	2.000
WRCS6-001	1	3.560	0.770	2.500

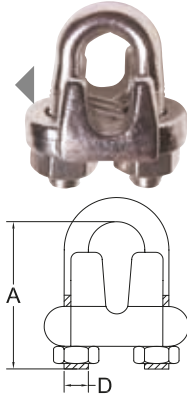

Wire Rope Clips (stainless steel 304)

Code	For Cable Diameter in.	Dimensions in.		Weight / each lbs.
		A	D	
WRCS4-116	1/16	0.705	0.150	0.020
WRCS4-018	1/8	0.830	0.195	0.030
WRCS4-532	5/32	0.905	0.205	0.040
WRCS4-316	3/16	0.945	0.235	0.060
WRCS4-014	1/4	1.285	0.300	0.090
WRCS4-516	5/16	1.375	0.312	0.190
WRCS4-038	3/8	1.725	0.385	0.370
WRCS4-012	1/2	2.130	0.465	0.596
WRCS4-058	5/8	2.405	0.540	1.000
WRCS4-034	3/4	2.630	0.560	1.500
WRCS4-078	7/8	3.150	0.630	2.000
WRCS4-001	1	3.500	0.630	2.500

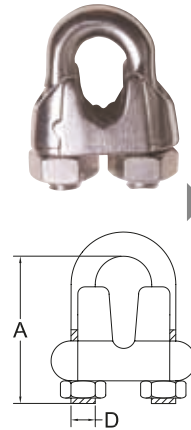

Not intended for overhead lifting

Lifting Eye Bolts (stainless steel 316)

Code	Working Load Limit lbs.	Weight / each lbs.	Dimensions in.				
			B	D	G	J	P
LEBS-014916	400	0.05	1.000	0.250	0.625	0.500	0.563
LEBS-516916	800	0.07	1.250	0.313	0.750	0.625	0.563
LEBS-0381116	1,350	0.14	1.563	0.375	1.000	0.750	0.688
LEBS-012078	2,100	0.30	2.000	0.500	1.250	1.000	0.875
LEBS-0581116	3,800	0.45	2.313	0.625	1.375	1.125	1.063
LEBS-034118	6,200	0.80	2.750	0.750	1.563	1.313	1.125
LEBS-034002	5,150	-	2.750	0.750	1.563	1.313	2.000
LEBS-0011516	9,500	1.65	3.500	1.000	2.000	1.750	1.375

Safety Factor 5:1

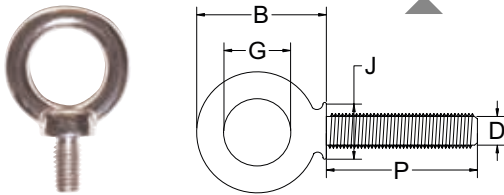

Eye Nuts (stainless steel)

Code	Working Load Limit lbs.	Weight / each lbs.	Thread	Dimensions in.			
				D	E	G	J
ENS-014	400	0.05	1/4	0.19	1.19	0.63	0.50
ENS-516	800	0.07	5/16	0.25	1.56	0.75	0.63
ENS-038	1,000	0.14	3/8	0.31	1.88	1.00	0.75
ENS-012	2,000	0.3	1/2	0.38	2.38	1.25	1.00
ENS-058	3,200	0.45	5/8	0.50	2.88	1.38	1.13
ENS-034	4,700	0.8	3/4	0.63	3.38	1.56	1.31

Safety Factor 5:1

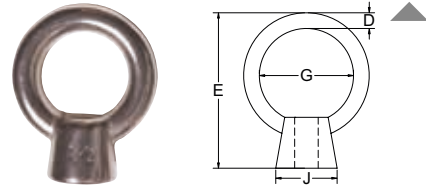

Shoulder Nut Eye Bolts (stainless steel 316)

Code	Working Load Limit lbs.	Weight / each lbs.	Dimensions in.				
			D	F	G	P	Q
SNEBS-014004	370	0.06	1/4	4 13/16	.495	2 5/8	4
SNEBS-516412	625	0.13	5/16	5 7/8	.620	2 7/16	4 1/2
SNEBS-038412	930	0.20	3/8	5 1/4	.759	2 1/2	4 1/2
SNEBS-012006	1,700	0.33	1/2	7 3/4	1.021	3	6

Safety Factor 5:1

UNC Threading

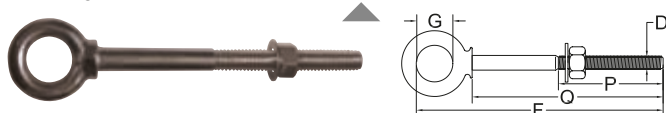

Shoulder Nut Eye Bolts Heavy Duty (stainless steel 316)

Code	Working Load Limit lbs.	Weight / each lbs.	Dimensions in.				
			D	E	F	G	P
HDSNEBS-014002	400	0.04	1/4	1.20	3	0.56	2.00
HDSNEBS-516004	800	0.15	5/16	1.55	5 1/4	0.75	4.00
HDSNEBS-038005	1,000	0.28	3/8	2.00	6 5/8	1.00	5.00
HDSNEBS-012006	2,000	0.50	1/2	2 3/8	7 7/8	1.16	6.00
HDSNEBS-058006	3,200	1.10	5/8	2.81	8 1/4	1.38	6.00
HDSNEBS-034006	4,700	1.60	3/4	3.36	8 5/8	1.56	6.00
HDSNEBS-001009	7,500	3.55	1	3.55	11 1/2	2.00	9.00

Safety Factor 5:1

UNC Threading

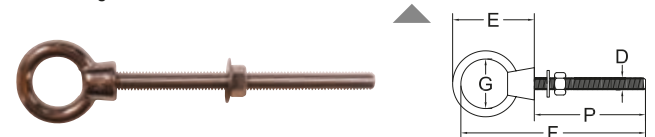

Ben-Mor Threaded Studs (stainless steel)

Code	For Cable Diameter in.	Thread D NF-3A or UNF-3A	Dimensions in.					
			C	D Before swage	D After swage	E Before swage	E After swage	P
BM21259-2	1/16	6-40	.188	.160	.138	2.473	2.650	1.045
BM21259-3	3/32	10-32	.250	.218	.190	2.879	2.996	1.204
BM21259-4	1/8	1/4-28	.313	.250	.219	3.333	3.589	1.376
BM21259-5	5/32	1/4-28	.313	.297	.250	3.627	3.972	1.376
BM21259-6	3/16	5/16-24	.375	.359	.313	4.002	4.170	1.458
BM21259-7	7/32	3/8-24	.438	.427	.375	4.516	4.812	1.625
BM21259-8	1/4	3/8-24	.500	.494	.438	4.937	5.236	1.750
BM21259-9	9/32	7/16-20	.625	.563	.500	5.391	5.750	1.875
BM21259-10	5/16	1/2-20	.688	.635	.563	5.844	6.266	2.000
BM21259-12	3/8	9/16-18	.750	.703	.625	6.656	7.069	2.250
BM21259-14	7/16	5/8-18	.812	.781	.688	7.437	7.910	2.500
BM21259-16	1/2	5/8-18	.875	.844	.750	8.187	8.742	2.500



Marine Eyes EY1 (stainless steel)

Code	For Cable Diameter in.	Weight / each lbs.	Dimensions in.					
			D Before swage	D After swage	G Before swage	T Before swage	X Before swage	X After swage
EY1-2	1/16	.015	0.160	0.138	0.264	0.218	1.500	1.809
EY1-3	3/32	.028	0.218	0.190	0.264	0.218	1.758	2.070
EY1-4	1/8	.033	0.250	0.219	0.264	0.218	2.088	2.401
EY1-5	5/32	.055	0.297	0.250	0.327	0.281	2.355	2.709
EY1-6	3/16	.090	0.359	0.313	0.389	0.359	2.750	3.147
EY1-7	7/32	.150	0.427	0.375	0.452	0.406	3.220	3.787
EY1-8	1/4	.250	0.494	0.438	0.514	0.468	3.625	4.282
EY1-9	9/32	.330	0.563	0.500	0.514	0.468	3.795	4.514
EY1-10	5/16	.500	0.635	0.563	0.640	0.593	4.495	5.274
EY1-12	3/8	.670	0.703	0.625	0.640	0.593	4.930	5.659
EY1-14	7/16	1.00	0.781	0.688	0.765	0.719	6.375	6.750
EY1-16	1/2	1.25	0.844	0.750	0.890	0.844	7.375	7.587

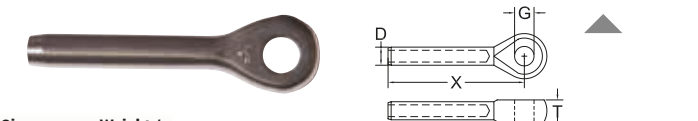

Jaw and Swage Terminals (stainless steel 316)

Code	For Cable Diameter in.	Size Diameter x Take-Up in.	Weight / each lbs.
TJS-018A	1/8	1/4 x 3 1/2	0.2
TJS-532A	5/32	1/4 x 3 1/2	0.2
TJS-532B	5/32	5/16 x 4 5/16	0.3
TJS-316A	3/16	5/16 x 4 5/16	0.3
TJS-316B	3/16	3/8 x 4 3/4	0.5

Code	For Cable Diameter in.	Size Diameter x Take-Up in.	Weight / each lbs.
TJS-732A	7/32	3/8 x 4 3/4	0.5
TJS-014A	1/4	3/8 x 4 3/4	0.6
TJS-014B	1/4	1/2 x 5 7/8	0.6
TJS-932A	9/32	7/10 x 5 1/8	0.7
TJS-932B	9/32	1/2 x 5 7/8	1.0
TJS-516A	5/16	1/2 x 5 7/8	1.8
TJS-516B	5/16	5/8 x 7 1/2	1.9
TJS-038A	3/8	5/8 x 7 1/2	2.0

Code	For Cable Diameter in.	Size Diameter x Take-Up in.	Weight / each lbs.
TJS-038B	3/8	3/4 x 8 5/8	3.7
TJS-012A	1/2	3/4 x 8 5/8	3.8

Not intended for overhead lifting



EYE & EYE



JAW & JAW



HOOK & HOOK

UNC threading

Precision Cast Turnbuckles (stainless steel 316)

Code E & E	Code J & J	Size Diameter x Take-Up in.	Working Load Limit lbs.	Code H & H	Size Diameter x Take-Up in.	Working Load Limit lbs.	Weight / each lbs.
TEES-316214	TJJS-316214	3/16 x 2 1/4	350	THHS-316214	3/16 x 2 1/2	100	0.10
TEES-014234	TJJS-014234	1/4 x 2 3/4	450	THHS-014234	1/4 x 3	200	0.20
TEES-516334	TJJS-516334	5/16 x 3 3/4	850	THHS-516334	5/16 x 4	400	0.37
TEES-038434	TJJS-038434	3/8 x 4 3/4	1,260	THHS-038434	3/8 x 6	700	0.60
TEES-012006	TJJS-012006	1/2 x 6	2,200	THHS-012006	1/2 x 6	1,000	1.25
TEES-058008	TJJS-058008	5/8 x 8	2,500	THHS-058008	5/8 x 8	1,500	2.38
TEES-034010	TJJS-034010	3/4 x 10	3,500	THHS-034010	3/4 x 10	2,000	4.00

Safety Factor 5:1

Not intended for overhead lifting



EYE & EYE

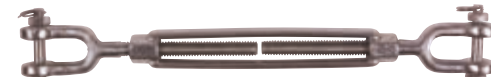

JAW & JAW



HOOK & HOOK

UNC threading

Forged Turnbuckles (stainless steel 316)

Code E & E	Code J & J	Size Diameter x Take-Up in.	Working Load Limit lbs.	Code H & H	Size Diameter x Take-Up in.	Working Load Limit lbs.	Weight / each lbs.
TEES-014004	TJJS-014004	1/4 x 4	500	THHS-014004	1/4 x 4	200	0.20
TEES-516412	TJJS-516412	5/16 x 4 1/2	800	THHS-516412	5/16 x 4 1/2	400	0.37
TEES-038006	TJJS-038006	3/8 x 6	1,200	THHS-038006	3/8 x 6	700	0.60
TEES-012006	TJJS-012006	1/2 x 6	2,200	THHS-012006	1/2 x 6	1,050	1.25
TEES-058006	TJJS-058006	5/8 x 6	3,500	THHS-058006	5/8 x 6	1,600	2.38
TEES-034006	TJJS-034006	3/4 x 6	5,200	THHS-034006	3/4 x 6	2,000	4.00

Safety Factor 5:1

Carbine Snap Hooks with Eyelets (stainless steel 316)

Code	Working Load Limit lbs.	Weight / each lbs.	Dimensions in.				
			D in. mm	E	F	G	H
S9-1	120	0.04	3/16 5	2.000	1.625	0.3125	0.2500
S9-2	160	0.06	1/4 6	2.375	1.875	0.3125	0.3125
S9-3	300	0.15	5/16 8	3.125	2.500	0.3750	0.3750
S9-4	400	0.32	3/8 10	4.000	3.250	0.6250	0.5625
S9-5	700	0.78	1/2 12	6.375	5.375	0.9375	1.0000

Safety Factor 3:1

Not intended for overhead lifting

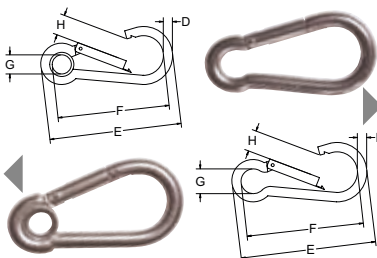

Carbine Snap Hooks (stainless steel 316)

Code	Working Load Limit lbs.	Weight / each lbs.	Dimensions in.				
			D in. mm	E	F	G	H
S11-1	120	0.04	3/16 5	2.000	1.625	0.313	0.250
S11-2	160	0.06	1/4 6	2.375	1.875	0.313	0.313
S11-3	300	0.15	5/16 8	3.125	2.500	0.375	0.375
S11-4	400	0.32	3/8 10	4.000	3.250	0.625	0.563
S11-5	700	0.78	1/2 12	6.375	5.375	0.938	1.000

Safety Factor 3:1

Not intended for overhead lifting



Screw Pin Shackles, bow type (stainless steel 316)

Code	Dim. in.	Working Load Limit lbs.	Weight / each lbs.	Dimensions in.							
				A	B	D	G	H	L	T	
SPAS-316S6	3/16	520	0.04	15/16	0.622	3/16	0.220	13/32	3/16	0.448	
SPAS-014S6	1/4	750	0.06	1 1/8	0.960	1/4	0.268	15/32	1/4	0.500	
SPAS-516S6	5/16	1,300	0.12	1 1/2	1.120	5/16	0.335	5/8	5/16	0.625	
SPAS-038S6	3/8	1,750	0.25	1 3/4	1.280	3/8	0.427	3/4	3/8	0.780	
SPAS-716S6	7/16	2,500	0.50	2 5/32	1.640	7/16	0.497	15/16	7/16	0.933	
SPAS-012S6	1/2	2,850	0.40	2 5/16	1.520	1/2	0.520	1.000	1/2	1.100	
SPAS-058S6	5/8	4,000	1.00	3.000	2.130	5/8	0.635	1 1/4	5/8	1.250	
SPAS-034S6	3/4	5,600	1.61	3 5/16	2.450	3/4	0.845	1 1/2	3/4	1.550	
SPAS-078S6	7/8	6,700	2.53	3 7/8	2.190	7/8	1.040	1 3/4	7/8	2.000	
SPAS-001S6	1	10,000	3.80	4 3/8	3.400	1.000	1.100	2.000	1.000	2.000	

Safety Factor 5:1

Do not use for lifting. Lifting application available on request.

Not intended for overhead lifting

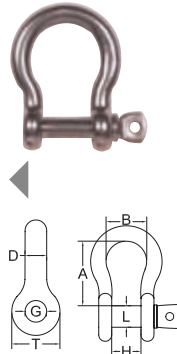

"S" Hooks (stainless steel 316)

Code	Working Load Limit lbs.	Dimensions in.			
		D		F	H
		in.	mm		
SHS-018	30	1/8	3	1.125	0.156
SHS-532	40	5/32	4	1.313	0.156
SHS-316	60	3/16	5	1.375	0.313
SHS-014	150	1/4	6	1.625	0.375
SHS-516	300	5/16	8	2.125	0.438

Not intended for overhead lifting

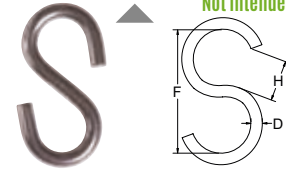

Screw Pin Shackles, chain type (stainless steel 316)

Code	Dim. in.	Working Load Limit lbs.	Weight / each lbs.	Dimensions in.					
				A	D	G	H	L	T
SPCS-316S6	3/16	650	0.08	0.750	0.188	0.210	0.375	0.250	0.400
SPCS-014S6	1/4	880	0.10	0.875	0.250	0.260	0.469	0.313	0.425
SPCS-516S6	5/16	1,300	0.18	1.000	0.313	0.325	0.500	0.375	0.620
SPCS-038S6	3/8	1,500	0.31	1.250	0.375	0.400	0.625	0.438	0.770
SPCS-012S6	1/2	3,000	0.68	1.625	0.500	0.525	0.875	0.625	1.020
SPCS-058S6	5/8	4,000	1.26	2.000	0.625	0.637	1.063	0.750	1.150

Safety Factor 5:1

Do not use for lifting. Lifting application available on request.

Not intended for overhead lifting

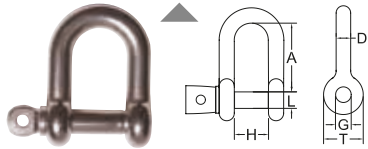

Quick links (stainless steel 316)

Classified Code	Working Load Limit lbs.	Weight / each lbs.	Dimensions in.				
			D		A	B	H
			in.	mm			
QLS-018	220	0.02	1/8	3	1.375	0.375	0.219
QLS-532	500	0.03	5/32	4	1.188	0.469	0.188
QLS-316	660	0.05	3/16	5	1.500	0.500	0.250
QLS-014	880	0.08	1/4	6	1.750	0.563	0.313
QLS-516	1,760	0.18	5/16	8	2.250	0.750	0.375
QLS-038	2,640	0.33	3/8	10	2.750	0.875	0.438
QLS-012	3,300		1/2	12			

Safety Factor 3:1

Not intended for overhead lifting



Eye Hooks (stainless steel 316)

Code	For Chain Size in.	Working Load Limit lbs.	Weight / each lbs.	Dimensions in.			
				D	F	G	H
EHS-014	1/4	880	0.30	1/4	2.520	0.520	0.680
EHS-516	5/16	1,320	0.50	5/16	2.850	0.650	0.750
EHS-038	3/8	1,760	0.90	3/8	3.300	0.700	0.800
EHS-012	1/2	2,640	1.80	1/2	4.120	0.920	1.020

Safety Factor 4:1

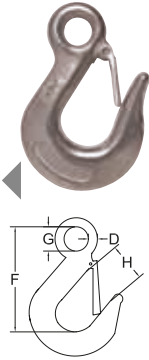

Swivel Hooks (stainless steel 316)

Code	Working Load Limit lbs.	Weight / each lbs.	Dimensions in.				
			B	D	E	F	H
SH4-014	880	0.42	0.875	1/4	4.000	3.600	0.625
SH5-516	1,320	0.72	1.125	5/16	5.000	4.210	0.750
SH6-038	1,760	1.16	1.188	3/8	6.000	4.750	0.875
SH8-012	2,640	1.42	1.375	1/2	8.000	5.875	1.188

Safety Factor 4:1

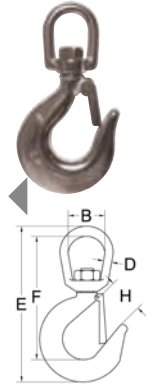

Fixed Eye Snaps (stainless steel 316)

Code	Working Load Limit lbs.	Weight / each lbs.	Dimensions in.				
			C	D	E	G	H
S1-0	100	0.06	0.88	0.16	2.13	0.38	0.22
S1-1	140	0.10	1.25	0.19	2.88	0.63	0.44
S1-2	240	0.14	1.38	0.22	3.25	0.75	0.50
S1-3	320	0.28	1.75	0.28	3.88	0.88	0.56

Safety Factor 3:1

Not intended for overhead lifting

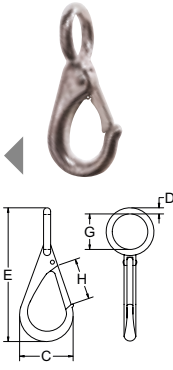

Safety Snap Hooks (stainless steel 316)

Code	Working Load Limit lbs.	Weight / each lbs.	Dimensions in.	
			F	H
S7-1	500	0.26	4 1/8	3/4
S7-2	600	0.42	4 3/4	1 1/8

Safety Factor 3:1 Not intended for overhead lifting

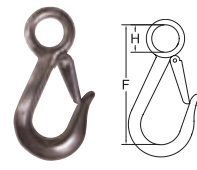

Swivel Eye Snaps (stainless steel 316)

Code	Working Load Limit lbs.	Weight / each lbs.	Dimensions in.			
			D	E	G	H
S2-1	120	0.13	0.19	3.38	0.63	0.38
S2-2	150	0.21	0.25	4.00	0.75	0.50

Safety Factor 3:1

Not intended for overhead lifting

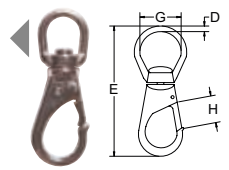

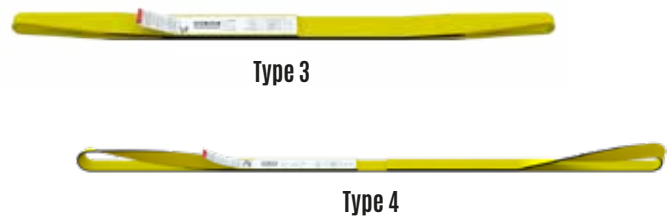
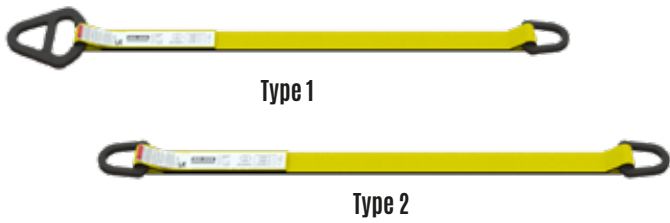

Synthetic Web Sling type # 1 - 2 - 3 - 4

SINGLE PLY

Width in.	Working Load Limit lbs.					Ply Nb	Hook	Ring	
	Vertical	Choker	Basket 90°	Basket 60°	Basket 45°				Basket 30°
1	1,600	1,280	3,200	2,770	2,260	1,600	1	EH-001	A342-012BM
2	3,100	2,480	6,200	5,360	4,380	3,100	1	EH-002	A342-012BM
3	4,700	3,760	9,400	8,140	6,640	4,700	1	EH-005	A342-012BM
4	6,200	4,960	12,400	10,730	8,760	6,200	1	EH-005	A342-012BM
6	9,300	7,440	18,600	16,100	13,150	9,300	1	EH-015	A342-034BM
8	11,750	9,400	23,500	20,350	16,610	11,750	1	EH-022	A342-001BM
10	14,700	11,760	29,400	25,460	20,780	14,700	1	EH-022	A342-001BM
12	17,650	14,120	35,300	30,560	24,950	17,650	1	CS-1023565	A342-112BM

Safety Factor 5:1

DOUBLE PLY

Width in.	Working Load Limit lbs.					Ply Nb	Hook	Ring	
	Vertical	Choker	Basket 90°	Basket 60°	Basket 45°				Basket 30°
1	3,100	2,400	6,200	5,300	4,300	3,100	2	EH-002	A342-012BM
2	6,200	4,960	12,400	10,700	8,700	6,200	2	EH-005	A342-012BM
3	8,800	7,040	17,600	15,200	12,400	8,800	2	EH-005	A342-058BM
4	11,000	8,800	22,000	19,000	15,500	11,000	2	EH-007	A342-034BM
6	16,500	13,200	33,000	28,500	23,300	16,500	2	EH-015	A342-001BM
8	22,750	18,200	45,500	39,400	32,100	22,750	2	EH-022	A342-001BM
10	28,400	22,720	56,800	49,100	40,100	28,400	2	EH-022	A342-114BM
12	34,100	27,280	68,200	59,000	48,200	34,100	2	CS-1023565	A342-112BM

Safety Factor 5:1

Note: 1" width not available for types 1 and 2.

Synthetic Web Sling type # 3 - 4

TRIPLE PLY

Width in.	Working Load Limit lbs.					Ply Nb	Hook	Ring	
	Vertical	Choker	Basket 90°	Basket 60°	Basket 45°				Basket 30°
1	4,100	3,300	8,200	7,050	5,780	4,100	3	EH-003	A342-012BM
2	8,300	6,600	16,600	14,470	11,700	8,300	3	EH-005	A342-058BM
3	12,500	10,000	25,000	21,500	17,600	12,500	3	EH-007	A342-001BM
4	16,000	12,800	32,000	27,500	22,500	16,000	3	EH-011	A342-001BM
6	23,000	18,400	46,000	39,500	32,400	23,000	3	EH-015	A342-001BM
8	30,700	24,500	61,400	52,800	43,300	30,700	3	EH-022	A342-114BM
10	36,800	29,400	73,600	63,300	51,900	36,800	3	EH-022	A342-114BM
12	44,000	35,200	88,000	75,700	62,000	44,000	3	CS-1023565	A342-112BM

Safety Factor 5:1

QUADRUPLE PLY

Width in.	Working Load Limit lbs.					Ply Nb	Hook	Ring	
	Vertical	Choker	Basket 90°	Basket 60°	Basket 45°				Basket 30°
1	5,500	4,400	11,000	9,500	7,700	5,500	4	EH-003	A342-012BM
2	11,000	8,800	22,000	19,000	15,500	11,000	4	EH-007	A342-034BM
3	16,450	13,100	32,900	28,400	23,200	16,450	4	EH-011	A342-001BM
4	20,400	16,300	40,800	35,300	28,800	20,400	4	EH-011	A342-001BM
6	30,600	24,400	61,200	52,900	43,200	30,600	4	EH-022	A342-114BM
8	39,700	31,700	79,400	68,600	56,000	39,700	4	EH-022	A342-112BM
10	49,600	39,600	99,200	85,800	69,900	49,600	4	CS-102332A	A342-112BM
12	59,500	47,600	119,000	102,900	83,900	59,500	4	CS-1023565	A342-134BM

Safety Factor 5:1

Material available: Polyester, Nylon Class 7: 9,800 lbs/in. = Breaking Strength

Synthetic slings should be used with wear pads. Wear pads will reduce the wear on the sling, and in turn extend the life of the sling. See page 41.

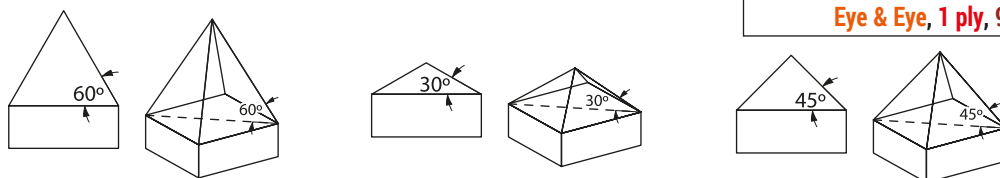
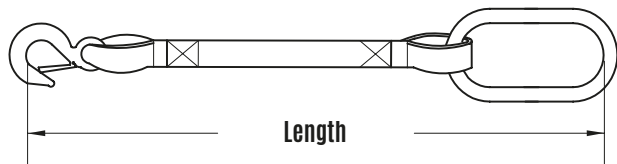

WARNING: The maximum loads shown are applicable only for new products or in perfect condition.

Do not exceed maximum rated capacities.

Product code

EE	1	9	01	Y	03	T3
Sling Type EE = Eye & Eye TT = Triangle & Triangle TC = Triangle & Choker EN = Endless	Number of ply	Capacity (9800 lbs./in.)	Largeur (inches)	Material Y = Polyester N = Nylon A = «Armour»	Length (feet)	Type
Eye & Eye, 1 ply, 9800 lbs./in., 1", Poly, 3', Type T3						



Synthetic Web Sling type # 5



SINGLE PLY

Width in.	Working Load Limit lbs.					
	Vertical	Choker	Basket 90°	Basket 60°	Basket 45°	Basket 30°
1	3,200	2,560	6,400	5,540	4,520	3,200
2	6,200	4,960	12,400	10,730	8,760	6,200
3	9,400	7,520	18,800	16,200	13,200	9,400
4	12,400	9,920	24,800	21,470	17,530	12,400
6	18,600	14,880	37,200	32,210	26,300	18,600
8	21,200	16,900	42,400	36,700	29,900	21,200
10	26,500	21,200	53,000	45,800	37,400	26,500
12	31,800	25,400	63,600	55,000	44,900	31,800

Safety Factor 5:1

DOUBLE PLY

Width in.	Working Load Limit lbs.					
	Vertical	Choker	Basket 90°	Basket 60°	Basket 45°	Basket 30°
1	6,200	4,960	12,400	10,700	8,700	6,200
2	12,400	9,920	24,800	21,400	17,500	12,400
3	17,600	14,080	35,200	30,400	24,800	17,600
4	22,000	17,600	44,000	38,100	31,100	22,000
6	33,000	26,400	66,000	57,100	46,600	33,000
8	42,300	33,800	84,600	73,200	59,800	42,300
10	52,900	42,300	105,800	91,600	74,800	52,900
12	63,500	50,800	127,000	109,900	89,700	63,500

Safety Factor 5:1

TRIPLE PLY

Width in.	Working Load Limit lbs.					
	Vertical	Choker	Basket 90°	Basket 60°	Basket 45°	Basket 30°
1	7,900	6,300	15,800	13,600	11,100	7,900
2	15,800	12,600	31,600	27,300	22,300	15,800
3	22,900	18,300	45,800	39,600	32,300	22,900
4	30,600	24,400	61,200	52,900	43,200	30,600
6	45,800	36,600	91,600	79,300	64,700	45,800
8	61,200	48,900	122,400	105,900	86,500	61,200
10	76,500	61,200	153,000	132,400	108,100	76,500
12	91,800	73,400	183,600	158,900	129,800	91,800

Safety Factor 5:1

QUADRUPLE PLY

Width in.	Working Load Limit lbs.					
	Vertical	Choker	Basket 90°	Basket 60°	Basket 45°	Basket 30°
1	10,200	8,100	20,400	17,600	14,400	10,200
2	19,800	15,800	39,600	34,200	27,900	19,800
3	30,000	24,000	60,000	51,900	42,400	30,000
4	39,600	31,600	79,200	68,500	55,900	39,600
6	59,500	47,600	119,000	103,000	84,100	59,500
8	81,600	65,200	163,200	141,300	115,300	81,600
10	102,000	81,600	204,000	176,600	144,200	102,000
12	122,400	97,900	244,800	211,900	173,000	122,400

Safety Factor 5:1

Type 6 (RE) return eye slings have protective webbing sewn on the body to provide a long lasting flexible and wear-resistant sling. These slings can be used in a vertical, choker or basket hitch.

SINGLE PLY

Code	Width in.	Working Load Limit lbs.		
		Vertical	Choker	Basket 90°
RE1902	2	3,100	2,300	6,200
RE1904	4	6,000	4,500	12,000
RE1906	6	8,600	6,450	17,200

Safety Factor 5:1

DOUBLE PLY

Code	Width in.	Working Load Limit lbs.		
		Vertical	Choker	Basket 90°
RE2902	2	6,100	4,500	12,200
RE2904	4	12,000	9,000	24,000
RE2906	6	16,300	12,200	32,600

Safety Factor 5:1

Type 6 - Return eye



These slings are designed for occasional or light duty lifting applications. They can be used in a vertical, choker & basket hitch. Available 1" & 1.75" only.

SINGLE PLY

Code	Width in.	Working Load Limit lbs.		
		Vertical	Choker	Basket 90°
EE1601	1	1,100	880	2,200
EE1675	1 3/4	1,900	1,425	3,800

Safety Factor 5:1

DOUBLE PLY

Code	Width in.	Working Load Limit lbs.		
		Vertical	Choker	Basket 90°
EE2601	1	2,200	1,650	4,400
EE2675	1 3/4	3,800	2,850	7,600

Safety Factor 5:1

Type 7 - Light duty eye & eye



SINGLE PLY

Code	Width in.	Working Load Limit lbs.		
		Vertical	Choker	Basket 90°
EN1601	1	2,200	1,750	4,400
EN1675	1 3/4	3,800	3,050	7,600

Safety Factor 5:1

DOUBLE PLY



Code	Width in.	Working Load Limit lbs.		
		Vertical	Choker	Basket 90°
EN2601	1	4,400	3,500	8,800
EN2675	1 3/4	7,700	6,100	15,400

Safety Factor 5:1

Type 7 - Light duty endless





Synthetic Web Sling, double leg

Number of plies	Material Width in.	Working Load Limit lbs.				
		60 °	45 °	30 °		
1	1	2,770	2,260	1,600	EH-001	A342-012BM
1	2	5,360	4,380	3,100	EH-002	A342-012BM
1	3	8,140	6,640	4,700	EH-005	A342-058BM
1	4	10,730	8,760	6,200	EH-005	A342-001BM
2	1	5,360	4,380	3,100	EH-002	A342-012BM
2	2	10,790	8,760	6,200	EH-005	A342-034BM
2	3	15,240	12,440	8,800	EH-005	A342-001BM
2	4	19,050	15,550	11,000	EH-007	A342-001BM
3	1	6,580	5,370	3,800	EH-003	A342-058BM
3	2	12,820	10,460	7,400	EH-005	A342-001BM
3	3	19,400	15,840	11,200	EH-007	A342-001BM
3	4	25,630	20,930	14,800	EH-011	A342-114BM
4	1	9,520	7,770	5,500	EH-003	A342-034BM
4	2	19,050	15,550	11,000	EH-007	A342-001BM
4	3	28,490	23,260	16,450	EH-011	A342-114BM
4	4	35,330	28,840	20,400	EH-011	A342-114BM

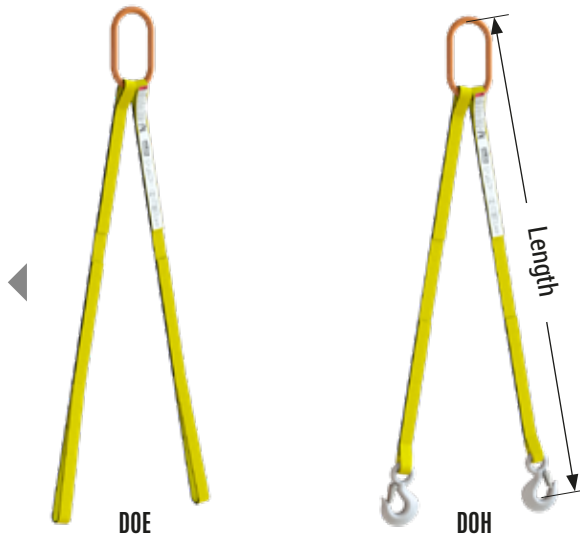
Safety Factor 5:1





Synthetic Web Sling, three legs

Number of plies	Material Width in.	Working Load Limit lbs.				
		60 °	45 °	30 °		
1	1	4,150	3,390	2,400	EH-001	A342-012BM
1	2	8,050	6,570	4,650	EH-002	A342-058BM
1	3	12,200	9,960	7,050	EH-005	A342-112BM
1	4	16,100	13,100	9,300	EH-005	A342-112BM
2	1	8,050	6,570	4,650	EH-002	A342-058BM
2	2	16,100	13,150	9,300	EH-005	A342-001BM
2	3	22,800	18,600	13,200	EH-005	A342-112BM
2	4	28,500	23,300	16,500	EH-007	A342-112BM
3	1	9,870	8,060	5,700	EH-003	A342-001BM
3	2	19,220	15,690	11,100	EH-005	A342-001BM
3	3	29,100	23,750	16,800	EH-007	A342-112BM
3	4	38,450	31,390	22,200	EH-011	A342-112BM
4	1	14,200	11,600	8,250	EH-003	A342-001BM
4	2	28,500	23,300	16,500	EH-007	A342-114BM
4	3	42,700	34,800	24,600	EH-011	A342-112BM
4	4	52,900	43,200	30,600	EH-011	A342-112BM

Safety Factor 5:1



Synthetic Web Sling, four legs

Number of plies	Material Width in.	Working Load Limit lbs.				
		60 °	45 °	30 °		
1	1	5,540	4,520	3,200	EH-001	A342-012BM
1	2	10,700	8,760	6,200	EH-002	A342-114BM
1	3	16,200	13,200	9,400	EH-005	A342-134BM
1	4	21,400	17,500	12,400	EH-005	A342-134BM
2	1	10,730	8,760	6,200	EH-002	A342-034BM
2	2	21,470	17,530	12,400	EH-005	A342-114BM
2	3	30,400	24,800	17,600	EH-005	A342-134BM
2	4	38,100	31,100	22,000	EH-007	A342-134BM
3	1	13,160	10,750	7,600	EH-003	A342-114BM
3	2	25,630	20,930	14,800	EH-005	A342-114BM
3	3	38,800	31,670	22,400	EH-007	A342-134BM
3	4	51,270	41,850	29,600	EH-011	A342-134BM
4	1	19,000	15,500	11,000	EH-003	A342-114BM
4	2	38,100	31,100	22,000	EH-007	A342-114BM
4	3	56,900	46,500	32,900	EH-011	A342-134BM
4	4	70,600	57,600	40,800	EH-011	A342-134BM

Safety Factor 5:1

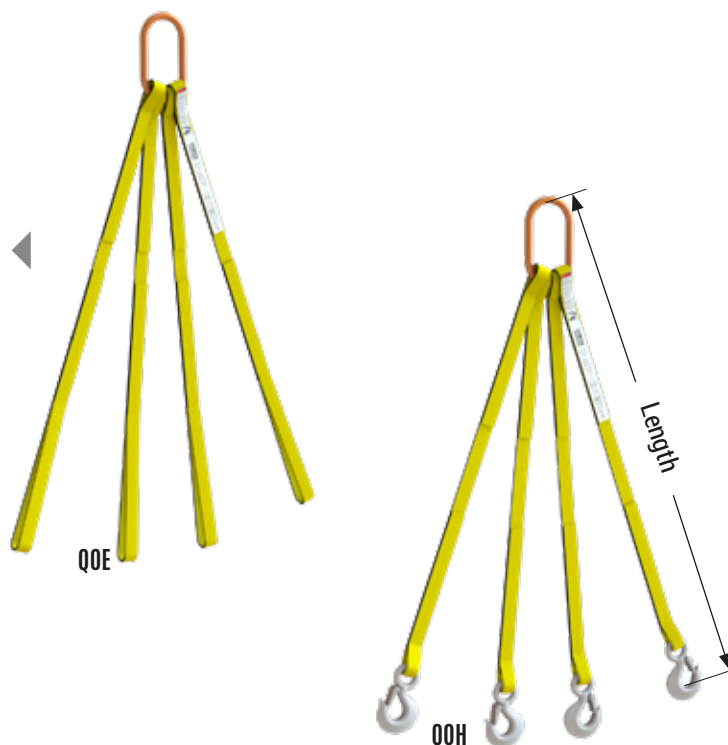

Material available : Polyester, Nylon
Class 7 : 9,800 lbs/in. = Fabric Tensile



Wear Pads

Synthetic slings should be used with wear pads. Wear pads will reduce the wear on the sling, and in turn extend the life of the sling.

	Material ID	Material Code	Description	Quality	Sliding	Sewn	Wrapped eye
	80	BNS	Ballistic Nylon Sandwich	Excellent	X		
	81	NYL	Nylon	Good	X		
	82	BAL	Ballistic Nylon Very high resistance to abrasion	Excellent	X	X	X
	83	COR	Cordura Nylon	Good	X	X	X
	84	DYT	Dyneema Tubing	Best	X		
	85	POT	Poly Tubing	Good	X		
	86	COT	Cordura Nylon Tubing	Good	X		
	87	ART	Armour Ploy Tubing	Very Good	X		
	88	PWY	Poly Web (Yellow CPL)	Good	X		
	89	PWA	Poly Web (Blue Armour)	Very Good	X		
	91	PYR	Pyro Jacket Protect against sparks and extreme heat	Good	X		
	94	PBP	Poly Blue Protector	Basic			X
	99	HTF	Xtreme Cover High-tech fiber yarns	Excellent	X	X	X



SLIDING
Type 02



SLIDING WITH VELCRO
Type 03



WRAPPED EYES

Product code

WITH SEWN WEAR PAD

EE	1	9	01	Y	03	T3	COR	02
Sling Type EE = Eye & Eye TT = Triangle & Triangle TC = Triangle & Choker EN = Endless	Number of ply	Capacity (9800 lbs./in.)	Width (inches)	Material Y = Polyester N = Nylon A = Armour	Length (feet)	Type	Material See "Material Code"	Protector Type See "Sewn Protector Type"

SLIDING WEAR PAD

WP	03	003	81
Wear Pad	Wear Pad Type 02 = Sliding 03 = Velcro Sliding	Width of Sling to fit. (inches)	Material See "Material ID"

Sewn Protector Type

Codes to use:

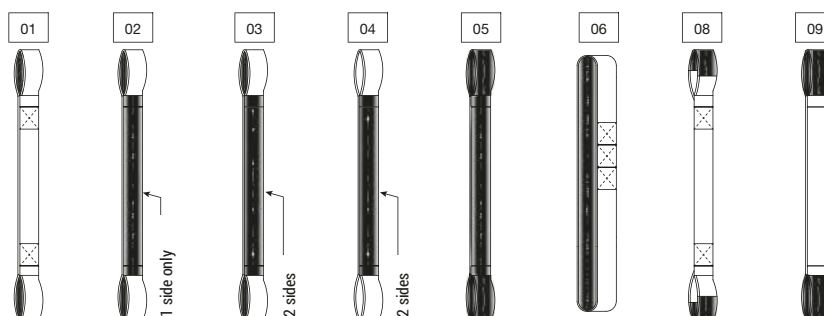

Wide lift slings provide maximum weight distribution of the load for those extra wide lifts. These slings have tapered eyes but can only be used in a basket hitch.

SINGLE PLY

Code	Width in.	Eye Length in.	Eye Width in.	Working Load Limit lbs.
				Basket
WL1906	6	9	1.5	15,400
WL1908	8	12	1.5	20,400
WL1912	12	18	2.5	30,800
WL1916	16	24	3	38,000
WL1920	20	30	3.5	45,000
WL1924	24	36	4.5	52,000

Safety Factor 5:1

DOUBLE PLY

Code	Width in.	Eye Length in.	Eye Width in.	Working Load Limit lbs.
				Basket
WL2906	6	9	1.5	28,600
WL2908	8	12	2	38,000
WL2912	12	18	3	57,200
WL2916	16	24	4	75,000
WL2920	20	30	5	90,000
WL2924	24	36	6	110,000

Safety Factor 5:1

Wide Lift Cargo Heavy Loads

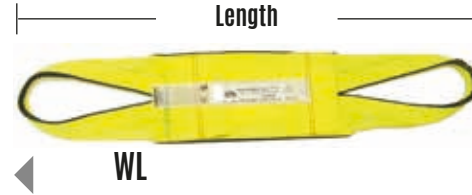

Wide lift light load slings are made with a single ply body and an eye is attached. Eyes are available in one ply (WLA1) and two plies (WLA2)

EYE SINGLE PLY

Code	Width in.	Eye Length in.	Web Width Used for Eye in.	Working Load Limit lbs.
				Basket
WLA1906	6	10	2	5,000
WLA1908	8	10	2	5,000
WLA1910	10	12	2	5,000
WLA1912	12	12	2	5,000
WLA1916	16	12	4	10,000
WLA1920	20	18	4	10,000
WLA1924	24	18	4	10,000

Safety Factor 5:1

EYE DOUBLE PLY

Code	Width in.	Eye Length in.	Web Width Used for Eye in.	Working Load Limit lbs.
				Basket
WLA2906	6	10	2	10,000
WLA2908	8	10	2	10,000
WLA2910	10	12	2	10,000
WLA2912	12	12	2	10,000
WLA2916	16	12	4	18,000
WLA2920	20	18	4	18,000
WLA2924	24	18	4	18,000

Safety Factor 5:1

Wide Lift Cargo Light Loads



EYE SINGLE PLY

Code	Width in.	Eye Length in.	Web Width Used for Eye in.	Working Load Limit lbs.
				Basket
WLE1906	6	10	1	5,000
WLE1908	8	10	1	5,000
WLE1910	10	12	1	5,000
WLE1912	12	12	1	5,000
WLE1916	16	12	2	10,000
WLE1920	20	18	2	10,000
WLE1924	24	18	2	10,000

Safety Factor 5:1

EYE DOUBLE PLY

Code	Width in.	Eye Length in.	Web Width Used for Eye in.	Working Load Limit lbs.
				Basket
WLE2906	6	10	1	10,000
WLE2908	8	10	1	10,000
WLE2910	10	12	1	10,000
WLE2912	12	12	1	10,000
WLE2916	16	12	2	18,000
WLE2920	20	18	2	18,000
WLE2924	24	18	2	18,000

Safety Factor 5:1

Wide Lift Cargo Light - Endless Style

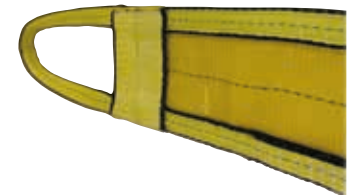

Steel Triangles (black paint)

Code	Working Load Limit lbs.	Weight approx. lbs.	Dimensions in.						
			A	B	C	E	G	I	T
TAC2C	6600	0.97	2.81	2.59	4.12	4.45	1.02	0.88	0.39
TAC3C	8800	1.9	3.06	3.61	5.71	5.19	1.76	1.06	0.47
TAC4C	11200	2.4	3.74	4.38	6.59	5.94	2.36	1.1	0.47
TAC5C	14000	4	4.65	5.43	8.58	7.4	2.6	1.38	0.47
TAC6C	16800	6	5.63	6.6	8.97	7.99	3	1.18	0.79
TAC8C	22800	15	6.5	8.46	12.91	10.83	4	2.17	0.79
TAC10C	28400	24	8.23	10.39	15.92	13.9	5	2.76	0.79
TAC12C	34200	32	9.06	12.6	19.02	15.75	6.77	3.31	0.79

Safety Factor 5:1

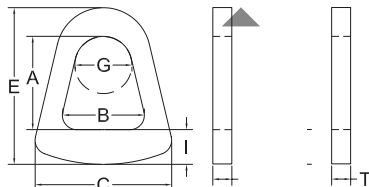

Steel Chokers (black paint)

Code	Working Load Limit lbs.	Weight approx. lbs.	Dimensions in.						
			A	B	C	E	G	I	T
CAC2C	6600	0.97	3.08	2.39	5.39	6.81	1.02	1.31	0.39
CAC3C	8800	1.9	3.06	3.5	7.91	7.75	1.76	1.57	0.47
CAC4C	11200	2.4	3.74	4.41	8.82	8.62	2.36	1.61	0.47
CAC5C	14000	4	3.74	5.51	11.46	9.45	2.6	1.69	0.47
CAC6C	16800	6	5.43	6.42	11.42	11.14	3	1.77	0.79
CAC8C	22800	15	6.5	8.46	17.64	15.16	4	2.76	0.79
CAC10C	28400	24	8.23	10.43	20.08	19.02	5	3.54	0.79
CAC12C	34200	32	9.02	12.4	24.09	21.85	6.77	4.17	0.79

Safety Factor 5:1

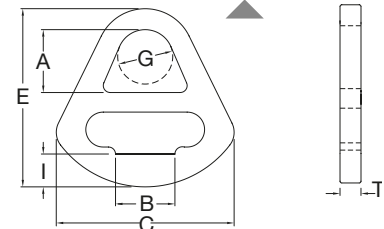

WARNING: The maximum loads shown are applicable only for new products or in perfect condition.

WARNING: Do not exceed maximum rated capacities.



Glass Slings

SINGLE PLY			
Code	Length in.	Height in.	Working Load Limit lbs.
GS1-078	78	36 to 54	12,400
GS1-108	108	60 to 84	12,400
GS1-124	124	72 to 100	12,400

Safety Factor 5:1

Glass Lifting Slings can be custom made to fit any size of glass. The slings are available with fully lined with rubber on the inside to protect the sling from the sharp edges.

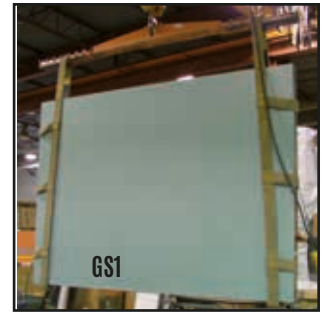

Transformer slings

DOUBLE PLY				
Code	Width in.	Leg length in.	Spread in.	Working Load Limit lbs.
TRAN15L	1 3/4	15	15	2,800
TRAN20L	1 3/4	20	20	2,800
TRAN22L	1 3/4	22	22	2,800
TRAN24L	1 3/4	24	24	2,800
TRAN30L	1 3/4	30	30	2,800

Safety Factor 5:1

Transformer slings are made to move transformers into place. They are made with an endless nylon sling as the link and 1-3/4" elastic web to ensure proper fit.



Custom fabrication

Ben-Mor takes pride in the custom work we do for our customers. All custom slings are made to a diagram that is approved by the customer before starting the manufacturing process. We identify the product with the diagram number and keep on file for future orders.

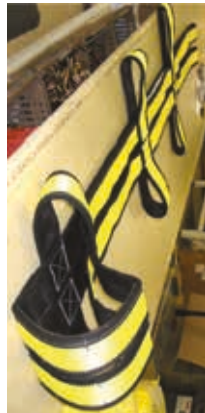

⚠ WARNING: The maximum loads shown are applicable only for new products or in perfect condition.

⚠ Do not exceed maximum rated capacities.

Marine Slings

Nylon Marine slings (MS) are lightweight and easy to use. They will not scratch or abuse the most delicate hull.



Extra eyes are available in tapered fabric or for use with hardware. Allows a single sling to adjust to different overall lengths.



Quick disconnect allow for easy removal and installation of slings. Protective flap included.



Keel pad is fastened to the sling at the centre to protect the sling from wear at the greatest load point.

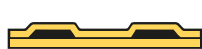

Lead weights keep slings under water. Allows easier positioning of slings under boat.

SINGLE PLY

Code	Width in.	Basket lbs.
MS1-903	3	9,400
MS1-904	4	12,400
MS1-906	6	18,600
MS1-908	8	23,500
MS1-910	10	29,400
MS1-912	12	35,300

DOUBLE PLY

Code	Width in.	Basket lbs.
MS2-903	3	17,600
MS2-904	4	22,000
MS2-906	6	33,000
MS2-908	8	45,500
MS2-910	10	56,800
MS2-912	12	68,200

Drum Slings

Drum sling safety lifts plastic and steel drums up to 1,000 lbs.

Code	Working Load Limit lbs.
DRUMSLING	1,000



Code	Width in.	Working Load Limit lbs.
AWN	Adjustable Wheel tie-down 14" – 20" Rim	1,500
LAS-07	7 ft. Wheel lift strap	1,500
LAS-09	9 ft. Wheel lift strap	1,500

Not intended for overhead lifting

Wheel tie-Down



Wheel Lift Strap





Tow Straps



Tow Straps Eye Style

Code	Ply Number	Width in.	Assembly breaking strength lbs.	Towing Capacity lbs.	Eye length in.	Approx. weight/ft in pounds
TSE1902	1	2	15,300	5,100	12	.20
TSE2902	2	2	31,000	10,300	12	.26
TSE1903	1	3	23,500	7,800	14	.30
TSE2903	2	3	44,000	14,600	14	.40
TSE1904	1	4	31,000	10,300	18	.40
TSE2904	2	4	55,000	18,300	18	.50
TSE1906	1	6	46,500	15,500	20	.65
TSE2906	2	6	82,000	27,300	20	.78
TSE1908	1	8	58,700	19,500	22	-
TSE2908	2	8	113,700	37,900	22	-

Safety Factor 3:1

Not intended for overhead lifting



Tow Straps Round Style

Code	Width in.	Assembly breaking strength lbs.	Towing Capacity lbs.	Eye length in.	Approx. weight/ft in pounds
TS-SL230E	4	115,000	38,300	16	1.25
TS-SL320E	4	160,000	53,300	16	1.75
TS-SL400E	5	200,000	66,600	18	2.25
TS-SL540E	6	270,000	90,000	20	2.75

Safety Factor 3:1

Not intended for overhead lifting



Tow Straps with Hooks

Code	Ply Number	Width in.	Assembly breaking strength lbs.	Towing Capacity lbs.	Hook Size (tons) Alloy	Approx. weight/ft in pounds
TSH1902	1	2	15,000	5,000	1.5	.30
TSH2902	2	2	30,000	10,000	3.0	.45
TSH1903	1	3	23,500	7,800	3.0	.46
TSH2903	2	3	44,000	14,600	5.0	.80

Safety Factor 3:1

Not intended for overhead lifting

Features

Nylon tow straps give you the flexibility and elasticity that tow chains do not offer.

These nylon tow straps have approximately 15% - 20% stretch.

Connect the tow straps to solid mounting points under the vehicle.

Tow straps are NOT for lifting

When recovering a vehicle, use straps with loops, not hooks that could retract and hit someone.

Always inspect the tow straps before each use. Look out for: cuts, knots, burns, or any other damage.

Warning: Do not use for overhead lifting

Custom sizes available on request.

Anchor Straps

Ben-Mor's Atlas Anchor straps become part of a fall arrest system. Anchor tie off points may differ according to the design of the project and or structure. It is important that all workers are trained so that all fall protection regulations are met. Ben-Mor's Atlas Anchor straps have a 5,000 lbs minimum breaking strength per strap and meet CSA, ANSI, and OSHA anchorage requirements.



Atlas Low Rise Anchor Strap LR2-42

2" X 42" complete with 4" loop at one end and 6" loop at the other end
5,000 Lbs minimum breaking strength

Not intended for overhead lifting



Atlas High Rise Anchor Strap HR2-42

2" X 42" complete with dee ring at one end and 6" loop at the other end
5,000 Lbs minimum breaking strength

Not intended for overhead lifting

ARMOUR WEB™



- Excellent abrasion resistance
- Best Value in Synthetic Web Slings
- Longer sling life reducing rigging costs
- Available in a wide range of sizes
- 100% Polyester
- 3% Elongation
- Maximum temperature exposure 180°F
- Better resistance to UV rays than Nylon
- Excellent chemical resistance

Results from a 5,000 cycle Hex-Bar Abrasion test proved **ARMOUR WEB** to be better than treated Nylon and treated Polyester.

Environmental considerations

WARNING

Nylon and Polyester are seriously degraded at temperatures above 200° F. Prolonged exposure to ultraviolet light adversely affects nylon and polyester. Slings become bleached and stiff when exposed to sunlight or arc welding. Many chemicals have an adverse effect on nylon and polyester. See chemicals chart.

Chemicals Chart		
Chemicals	Nylon	Polyester
Acids	NOT OK	OK *
Bleaching Agents	NOT OK	OK
Alcohols	OK	OK
Aldehydes	OK	NOT OK
Weak alkaline	OK	OK
Strong alkaline	OK	OK **
Ketones	OK	OK
Dry Cleaning Solvents	OK	OK
Water & Seawater	OK	OK
Ethers	OK	NOT OK
Oils Crude	OK	OK
Oils Lubricating	OK	OK
Hydrocarbons	OK	OK
Halogenated Hydrocarbons	OK	OK
Soap Detergents	OK	OK

* Disintegrated by concentrated sulfuric acid.

** Degraded by strong alkaline concentration at elevated temperature.

Angle reduction

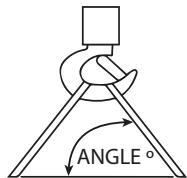

CAUTION: SLING SHOULD FIT THE HOOK

On eye and eye type slings, the eyes must be of ample length to easily slip over the crane hook, thus reducing stress on stitching.

Reduction of sling capacity depends on the angle of the Sling leg. See chart for loss factor.

Rated capacities are affected by angle of lift (sling to load angle) measured from the horizontal when used with multi-legged slings or choker/basket hitches.

To determine the actual capacity at a given angle of lift, multiply the original sling rating by the appropriate loss factor determined from the table. Example:

Angle Degrees	Loss Factor
90°	1
85°	0.996
80°	0.985
75°	0.966
70°	0.94
65°	0.906
60°	0.866
55°	0.819
50°	0.766
45°	0.707
40°	0.643
35°	0.574
30°	0.500

$$\begin{matrix} \text{Web Sling Rating} \\ \text{EE2-902} \\ \text{6,200 lbs} \end{matrix} \times \begin{matrix} \text{60° angle} \\ \text{reduction} \\ \text{.866} \end{matrix} \times \begin{matrix} \text{Nombre} \\ \text{of legs 2} \end{matrix} = \begin{matrix} \text{2 Leg Bridle} \\ \text{EE2-902} \\ \text{10,730 lbs} \end{matrix}$$

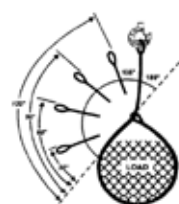

Angle of Chocke (degrees)	% of single leg chocker hitch capacity
120 - 180	100%
90 - 120	87%
60 - 89	74%
30 - 59	62%
0 - 29	49%



Stage rigging

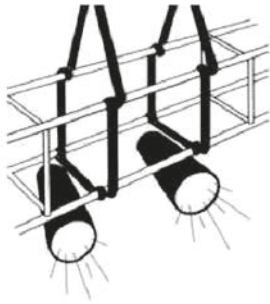

Features

- High heat resistance 400°F
- Excellent flexibility
- High abrasion resistance (longer sling life)
- Made for stage rigging over-head suspension
- Optional inspection window to inspect all inside wires

Steel Slingers - Steel

Steel Slingers are manufactured from multiple galvanized cables for strength, extreme flexibility and heat resistance and then covered in a jacket for high abrasion resistance.



Working Load Limit (lbs.)

Code	Color	Working Load Limit (lbs.)					Approx. Diameter in.	Approx. Weight / ft. Pounds
		Vertical	Choker	Basket 90°	Basket 60°	Basket 45°		
STL30	Black	3,000	2,400	6,000	5,200	4,200	0.75	0.30
STL40	Black	4,000	3,200	8,000	6,900	5,600	0.80	0.40
STL60	Black	6,000	4,800	12,000	10,300	8,400	0.90	0.45

Safety Factor 5:1

Available Options/



Velcro inspection window

Clear inspection window

Inspection area under tag, where wires are easily checked for damage.

1" Endless Straps

Code	End Hardware	Width in.	Length Ft.	Working Load Limit (lbs.)
RSEN1-08BLK	Ratchet Strap - Endless	1	8	1,100
RSEN1-12BLK	Ratchet Strap - Endless	1	12	1,100
RSEN1-16BLK	Ratchet Strap - Endless	1	16	1,100
RSEN1-24BLK	Ratchet Strap - Endless	1	24	1,100

Safety Factor 3:1

Not intended for overhead lifting



Powder coated colored thimbles available for easy length distinction.

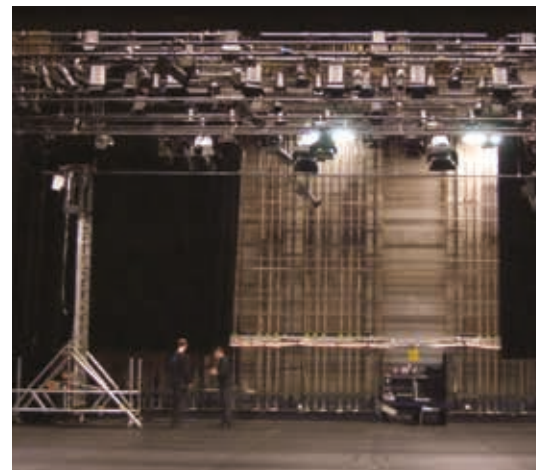

Slinger Round Slings Features

The most flexible sling available

The sling conforms to the load extremely well, and provides the best choker hold

Hook and load contact points can be continually rotated to extend the service life of the sling

Longer life means cost reduction in sling purchases

The load bearing fiber never comes into contact with the load

Protection to the load from sling damage

Seamless cover, no edge to wear out

Wide variety of sling lengths and load capacities

Adapts to all types, sizes, and load

Lightweight, easy to rig, store, and clean

Excellent resistance to ultraviolet light, rot, and mildew

No loss of strength in water

Only 3% elongation

Maximum temperature exposure 194°F

No metal parts on the sling, will not rust

Configurations



Slinger Construction

Slinger round slings are constructed from a multiple of high tenacity polyester yarns in an endless or continuous loop. These load bearing yarns are protected by two woven polyester jackets which act as a buffer between the load and the polyester yarn.

It is recommended to always use wear pads.

Product code: WPCPB

(See below)

Wear pads

All Slinger Round Slings shall be used with wear pads. Using wear pads will protect your investment of a round sling and/or high performance sling as well as lower risk of accidents or injuries. There are many options available with qualities varying from good to ultimate.

Xtreme Tubing

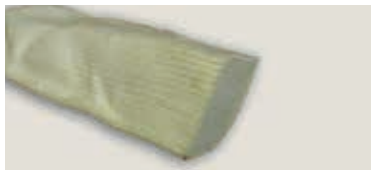

Xtreme wear pads provide the Ultimate protection against abrasion. These wear pads are specifically designed to be used on loads with sharp edges.

Corner Wear Pad

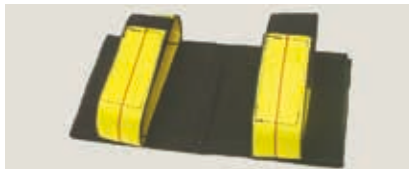

These wear pads are necessary when lifting around sharp corners. The bulky protection pad ensures that the sling will not be damaged.

*Also available with Xtreme cover.



Armour Tubing

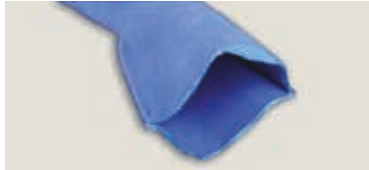

Armour wear pads are a great solution to abrasive surfaces. These wear pads will prolong the life of the sling.

Ballistic Nylon



Ballistic Nylon wear pads offer extensive protection to the sling.

Velcro Ties









Velcro ties hold the wear pad in place.



Slinger Polyester Round Slings

Working Load Limit (lbs.)

Code	Color Code							Minimum Length ft.	Diameter in.	Weight lbs./ft.
		Vertical	Choker	Basket 90°	Basket 60°	Basket 45°	Basket 30°			
SL 30	Purple	3,000	2,400	6,000	5,100	4,200	3,000	18"	.75	.25
SL 40	Black	4,000	3,200	8,000	6,900	5,600	4,000	18"	.80	.35
SL 60	Green	6,000	4,800	12,000	10,300	8,400	6,000	18"	.90	.40
SL 90	Yellow	9,000	7,200	18,000	15,500	12,600	9,000	18"	1.00	.50
SL 120	Beige	12,000	9,600	24,000	20,600	16,800	12,000	18"	1.25	.75
SL 140	Red	14,000	11,200	28,000	24,100	19,600	14,000	18"	1.30	.85
SL 170	Orange	17,000	13,600	34,000	29,300	23,800	17,000	18"	1.60	.95
SL 230	Blue	23,000	18,400	46,000	39,500	32,200	23,000	18"	1.65	1.25
SL 260	Orange	26,000	20,800	52,000	44,700	36,400	26,000	2	1.75	1.45
SL 320	Grey	32,000	25,600	64,000	55,000	44,800	32,000	2	2.15	1.75
SL 400	Orange	40,000	32,000	80,000	68,800	56,000	40,000	3	2.45	2.25
SL 540	Brown	54,000	43,200	108,000	92,900	75,600	54,000	4	3.00	2.75
SL 680	Olive	68,000	54,400	136,000	117,000	95,200	68,000	4	3.25	3.60
SL 900	Black	90,000	72,000	180,000	155,000	126,000	90,000	4	3.75	4.10

Safety Factor 5:1



Code	Color Code	MIN. Connection Hardware Thickness Vertical or Choker in.	MIN. Connection Hardware Thickness Basket in.	MIN. Connection Hardware Effective Contact Width Vertical or Choker in.	MIN. Connection Hardware Effective Contact Width Basket in.
SL 30	Purple	0,500	0,625	1,000	1,375
SL 40	Black	0,625	0,875	1,000	1,375
SL 60	Green	0,625	1,000	1,375	1,875
SL 90	Yellow	0,750	1,125	1,750	2,375
SL 120	Beige	1,000	1,375	1,875	2,500
SL 140	Red	1,000	1,500	2,000	2,875
SL 170	Orange	1,125	1,750	2,125	3,000
SL 230	Blue	1,250	1,875	2,625	3,750
SL 260	Orange	1,375	1,875	2,875	4,000
SL 320	Grey	1,500	2,125	3,250	4,500
SL 400	Orange	1,625	2,375	3,625	5,000
SL 540	Brown	2,000	2,750	4,000	5,625
SL 680	Olive	2,125	3,000	4,625	6,500
SL 900	Black	2,500	3,500	5,250	7,375

Safety Factor 5:1



⚠ WARNING: The maximum loads shown are applicable only for new products or in perfect condition.

⚠ Do not exceed maximum rated capacities.

Eye & Eye Slinger Round Slings

Eye & eye round slings are made with polyester tubing slid over both legs to create the eyes on each end. For improved abrasion resistance, we can supply ballistic nylon to create the Eye & Eye round slings. (Code: ...EB)

We can also cover the eyes with ballistic nylon. (For ballistic nylon eyes, add «BAL09» at the end of the part number)

Code	Standard Eye size in.	Color	Working Load Limit (lbs.)				
			Vertical	Choker	Basket 90°	Basket 60°	Basket 45°
SL-30E	12	Purple	3,000	2,400	6,000	5,200	4,200
SL-40E	12	Black	4,000	3,200	8,000	6,900	5,600
SL-60E	12	Green	6,000	4,800	12,000	10,300	8,400
SL-90E	12	Yellow	9,000	7,200	18,000	15,500	12,600
SL-120E	12	Tan	12,000	9,600	24,000	20,600	16,800
SL-140E	12	Red	14,000	11,200	28,000	24,100	19,600
SL-170E	12	Orange	17,000	13,600	34,000	29,300	23,800
SL-230E	18	Blue	23,000	18,400	46,000	39,500	32,200
SL-260E	18	Orange	26,000	20,800	52,000	44,700	36,400
SL-320E	18	Grey	32,000	25,600	64,000	55,000	44,800
SL-400E	20	Orange	40,000	32,000	80,000	68,800	56,000
SL-540E	24	Brown	54,000	43,200	108,000	92,900	75,600
SL-680E	30	Olive	68,000	54,400	136,000	117,000	95,200
SL-900E	30	Black	90,000	72,000	180,000	155,000	126,000

Safety Factor 5:1



⚠ WARNING: The maximum loads shown are applicable only for new products or in perfect condition.

⚠ Do not exceed maximum rated capacities.



Slinger Bridle Slings ; 1 to 4 Legs

Code	Color	SINGLE 90° Vertical		DOUBLE LEG BRIDLE			Alloy Hook TON	Master Link Diameter in.	
		ANGLE °	ANGLE °	60°	45°	30°		SINGLE	DOUBLE
SL-30	Purple	3,000	5,200	4,200	3,000	2	1/2	3/4	
SL-40	Black	4,000	6,900	5,600	4,000	5	1/2	5/8	
SL-60	Green	6,000	10,300	8,400	6,000	7	1/2	1	
SL-90	Yellow	9,000	15,500	12,700	9,000	7	5/8	1	
SL-120	Beige	12,000	20,700	16,900	12,000	11	1	1 1/4	
SL-140	Red	14,000	24,200	19,700	14,000	11	1	1 1/4	
SL-170	Orange	17,000	29,400	24,000	17,000	15	1	1 1/2	
SL-230	Blue	23,000	39,800	32,500	23,000	22	1 1/4	1 1/2	
SL-260	Orange	26,000	45,000	36,700	26,000	22	1 1/4	1 3/4	
SL-320	Grey	32,000	55,400	45,200	32,000	30	1 1/2	2	
SL-400	Orange	40,000	69,200	56,500	40,000	37	1 1/2	2	
SL-540	Brown	54,000	93,500	76,300	54,000	45	1 3/4	2 1/4	
SL-680	Olive	68,000	117,700	96,100	68,000	60	2	2 3/4	
SL-900	Black	90,000	155,850	127,200	90,000	n/a	2 1/4	3 1/4	

Safety Factor 5:1



Slinger Bridle Slings are custom made depending on the customer's needs. Hooks or eyes can be installed upon manufacturing. The customer can also supply their own accessories to install on its sling.

Code	Color	SINGLE 90° Vertical		THREE LEG BRIDLE			Alloy Hook TON	Master Link Diameter in.	
		ANGLE °	ANGLE °	60°	45°	30°		SINGLE	TRIPLE
SL-30	Purple	3,000	7,700	6,300	4,500	2	1/2	5/8	
SL-40	Black	4,000	10,300	8,400	6,000	5	1/2	3/4	
SL-60	Green	6,000	15,500	12,700	9,000	7	1/2	1	
SL-90	Yellow	9,000	23,300	19,000	13,500	7	5/8	1 1/4	
SL-120	Beige	12,000	31,100	25,400	18,000	11	1	1 1/2	
SL-140	Red	14,000	36,300	29,600	21,000	11	1	1 1/2	
SL-170	Orange	17,000	44,100	36,000	25,500	15	1	1 3/4	
SL-230	Blue	23,000	59,700	48,700	34,500	22	1 1/4	2	
SL-260	Orange	26,000	67,500	55,100	39,000	22	1 1/4	2	
SL-320	Grey	32,000	83,100	67,800	48,000	30	1 1/2	2 1/4	
SL-400	Orange	40,000	103,900	84,800	60,000	37	1 1/2	2 1/2	
SL-540	Brown	54,000	140,200	114,500	81,000	45	1 3/4	2 3/4	
SL-680	Olive	68,000	176,600	144,200	102,000	60	2	3 1/2	
SL-900	Black	90,000	233,800	190,800	135,000	n/a	2 1/4	4	

Safety Factor 5:1



Code	Color	SINGLE 90° Vertical		FOUR LEG BRIDLE			Alloy Hook TON	Master Link Diameter in.	
		ANGLE °	ANGLE °	60°	45°	30°		SINGLE	QUAD.
SL-30	Purple	3,000	10,300	8,400	6,000	2	1/2	3/4	
SL-40	Black	4,000	13,800	11,300	8,000	5	1/2	1	
SL-60	Green	6,000	20,700	16,900	12,000	7	1/2	1 1/4	
SL-90	Yellow	9,000	31,100	25,400	18,000	7	5/8	1 1/2	
SL-120	Beige	12,000	41,500	33,900	24,000	11	1	1 3/4	
SL-140	Red	14,000	48,500	39,500	28,000	11	1	1 3/4	
SL-170	Orange	17,000	58,800	48,000	34,000	15	1	2	
SL-230	Blue	23,000	79,600	65,000	46,000	22	1 1/4	2 1/4	
SL-260	Orange	26,000	90,000	73,500	52,000	22	1 1/4	2 1/4	
SL-320	Grey	32,000	110,800	90,400	64,000	30	1 1/2	2 3/4	
SL-400	Orange	40,000	138,500	113,100	80,000	37	1 1/2	2 3/4	
SL-540	Brown	54,000	187,000	152,700	108,000	45	1 3/4	3 1/2	
SL-680	Olive	68,000	235,500	192,304	136,000	60	2	4	
SL-900	Black	90,000	311,700	254,500	180,000	n/a	2 1/4	4 1/2	

Safety Factor 5:1



WARNING: The maximum loads shown are applicable only for new products or in perfect condition.

Heavy Lifting... Light Slings!

Super Slinger

High Performance Round Slings

Super Slings can be 15 times lighter than steel
 Reduce the amount of manpower needed for the job.
 Reduce the hours it takes to do the lift.
 Super Slings weigh less than 16% of what a wire rope sling would weigh.

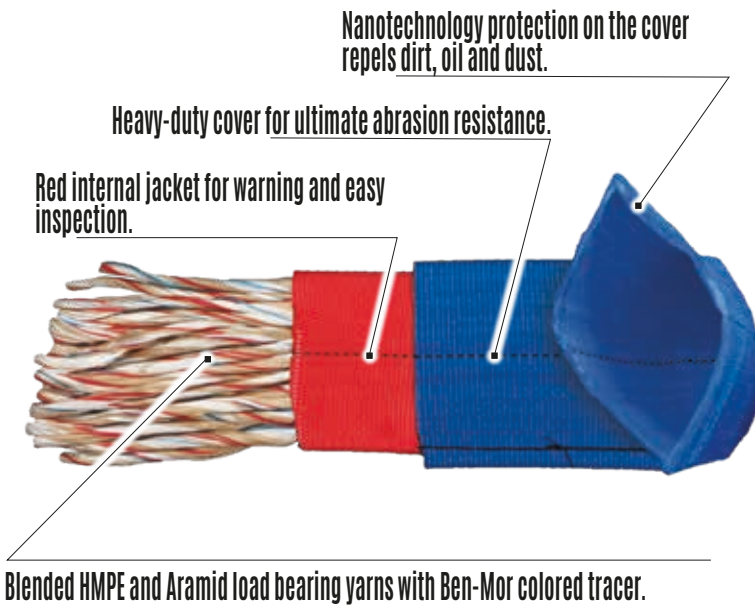

Building the world, one lift at a time!

First ever round sling with Nanotechnology applied on the cover

STAYS CLEAN



Durable protective function

Due to the extremely high level of abrasion resistance, the Nano cover protective function is retained even with heavy-duty use, frequent washing or cleaning.

Naturally Self-cleaning

Oil, dirt and dust do not adhere to the Nano surface and can be rinsed off with water.



Heavy Lifting... Light Slings!



Super Slinger High Performance Round Slings

Rely on full inspection

Prevent delays! Save money!
Pre-failure warnings on slings often present a false alarm, when in fact the sling is ok to use. Prevent delays with your lift, and save money with inspection costs by using Super Slings.

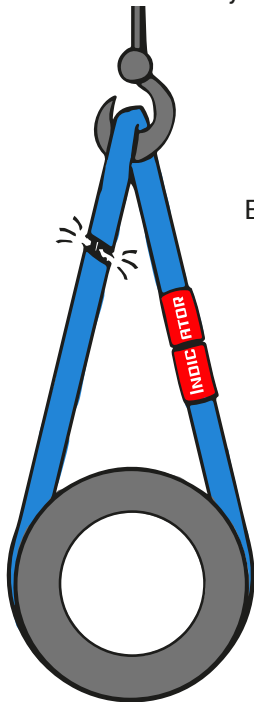

NEVER rely only on overload indicators
Even with overload indicators you must inspect the entire length of the sling.

No, the sling is damaged!

The indicator is okay, we can proceed.



Hey Boss, we just received this sling back from inspection, I put it up on crane, and pre-failure warnings have failed again. What should I do?

You can't use it, put the sling in the barrel with the others.

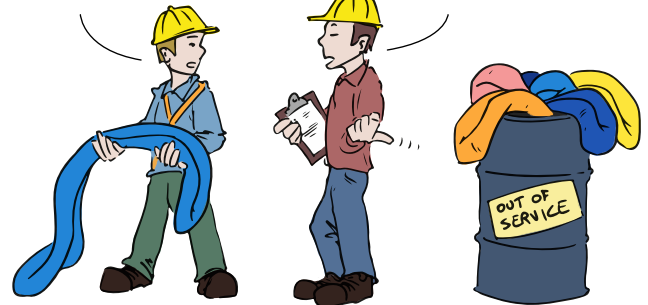

Meets ASME B30.9 standard!

ASME B30.9 states inspection **MUST** be done on the entire length of the sling!



Super Slinger High Performance Round Slings

Code	Color	Minimum Length	Working Load Limit (lbs.)				Approx. Diameter in.	Approx. Weight / ft lbs.	
			Vertical	Choker	Basket 90°	Basket 60°			Basket 45°
SSA200	Blue	18"	20,000	16,000	40,000	34,600	28,000	1 1/4	0.55
SSA250	Blue	18"	25,000	20,000	50,000	43,200	35,000	1 1/4	0.65
SSA300	Blue	2 ft	30,000	24,000	60,000	51,900	42,000	1 3/8	0.80
SSA400	Blue	3 ft	40,000	32,000	80,000	69,200	56,000	1 3/4	1.10
SSA500	Blue	3 ft	50,000	40,000	100,000	86,500	70,000	1 7/8	1.50
SSA600	Blue	3 ft	60,000	48,000	120,000	103,800	84,000	2	1.60
SSA700	Blue	4 ft	70,000	56,000	140,000	121,100	98,000	2 1/2	1.65
SSA850	Blue	4 ft	85,000	68,000	170,000	147,000	119,000	2 1/2	1.85
SSA1000	Blue	5 ft	100,000	80,000	200,000	173,000	140,000	2 3/4	2.20
SSA1250	Blue	5 ft	125,000	100,000	250,000	216,200	175,000	3	3.00
SSA1500	Blue	6 ft	150,000	120,000	300,000	259,500	210,000	3 1/4	3.35
SSA1750	Blue	6 ft	175,000	140,000	350,000	302,700	245,000	3 1/2	4.00
SSA2000	Blue	8 ft	200,000	160,000	400,000	346,000	280,000	3 3/4	4.35
SSA2250	Blue	8 ft	225,000	180,000	450,000	389,700	318,000	5	5.00
SSA2500	Blue	10 ft	250,000	200,000	500,000	433,000	353,000	5 1/2	5.85
SSA2750	Blue	10 ft	275,000	220,000	550,000	476,300	388,000	6	6.50
SSA3000	Blue	10 ft	300,000	240,000	600,000	519,600	424,000	6 1/2	7.15
SSA4000	Blue	10 ft	400,000	320,000	800,000	692,800	565,600	7	7.00
SSA5000	Blue	10 ft	500,000	400,000	1,000,000	866,000	707,000	8	8.50
SSA6000	Blue	10 ft	600,000	480,000	1,200,000	1,039,200	848,400	9	10.00

Safety Factor 5:1

Elongation at WLL	1%
Density	Floats
Moisture Retention	1%
Yarn Abrasion Resistance	Excellent (yarn on yarn)
Cover Abrasion Resistance	Excellent
UV Resistance	Very Good
Loss Strength when wet	0%

Xtreme Cover

Made with covers woven with Dyneema® yarns

Covers woven with Dyneema® yarns provide the ultimate protection for slings, and have the highest resistance to cuts and abrasion. Dyneema® is a synthetic material that protects your load while protecting your sling at the same time. This sling is specifically designed to be used on loads with sharp edges.

Durability:

Dyneema® fibers are produced from polyethylene and do not contain any aromatic rings nor any amide, hydroxylic or other chemical groups that are susceptible to attack by aggressive agents. The result is a highly crys-talline fiber with excellent resistance to water, moisture, most chemicals, UV light and micro organisms.

High Energy Absorption:

Dyneema® fibers can absorb extremely high amounts of energy. This property is utilized in products for ballistic protection, but this makes the fiber equally suited for products such as cut-resistant gloves, motor helmets and to improve the impact strength of laminated boat hulls. In these applications not only the high tenacity is used but also the high energy absorption.

Dyneema® is a registered trademark.

Contact us for more information. Item Code: SSX



Wear pads made with Dyneema® yarns flipping a mold

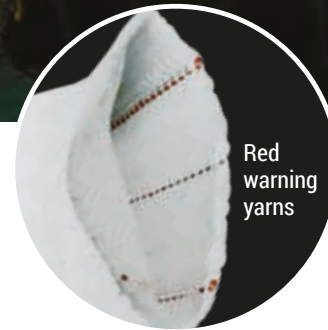

Red warning yarns

Made with covers woven with Dyneema® yarns

Ultimate Edge Protection

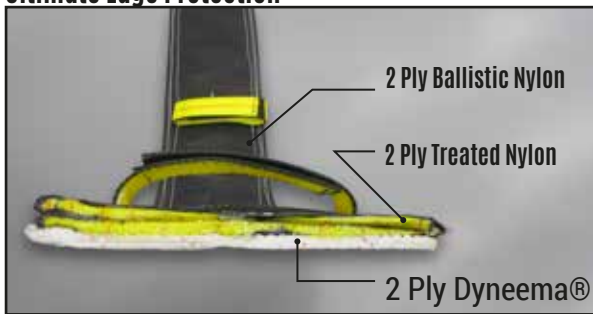

Easy Velcro attachment

Code	Width of Wear Pad in.	Width of sling it fits over in.
WPCPX04	4	Up to 4
WPCPX06	6	Up to 6
WPCPX08	8	Up to 8

*Build any length you need.



Corner Protector Xtreme wear pad

Wear Pad Corner Protector Xtreme (WPCPX) will reduce wear on the sling, prevent cutting, and extend the life of the sling. Corner Protector Xtreme provides ultimate protection against abrasion. Corner Protector Xtreme are made from synthetic material with Dyneema® high-tech fiber yarns that will protect your load while protecting your sling at the same time. With a cut protection rating of 25,000 lbs per inch of sling width, these wear pads are specifically designed to be used on loads with sharp edges. The pads can be secured to the sling to prevent the pad from slipping between lifts. The Corner Protector Xtreme wear pads allow the use of synthetic slings in applications where wire and chain slings were mandatory.

FOR ALL YOUR LIFTING NEEDS

The Super Slinger round slings were a part of an extension at Rockefeller University River Campus in Manhattan. The Super Slings lifted 19 modules weighting 150 Tons from a barge on the East River over the Franklin D. Roosevelt Drive.

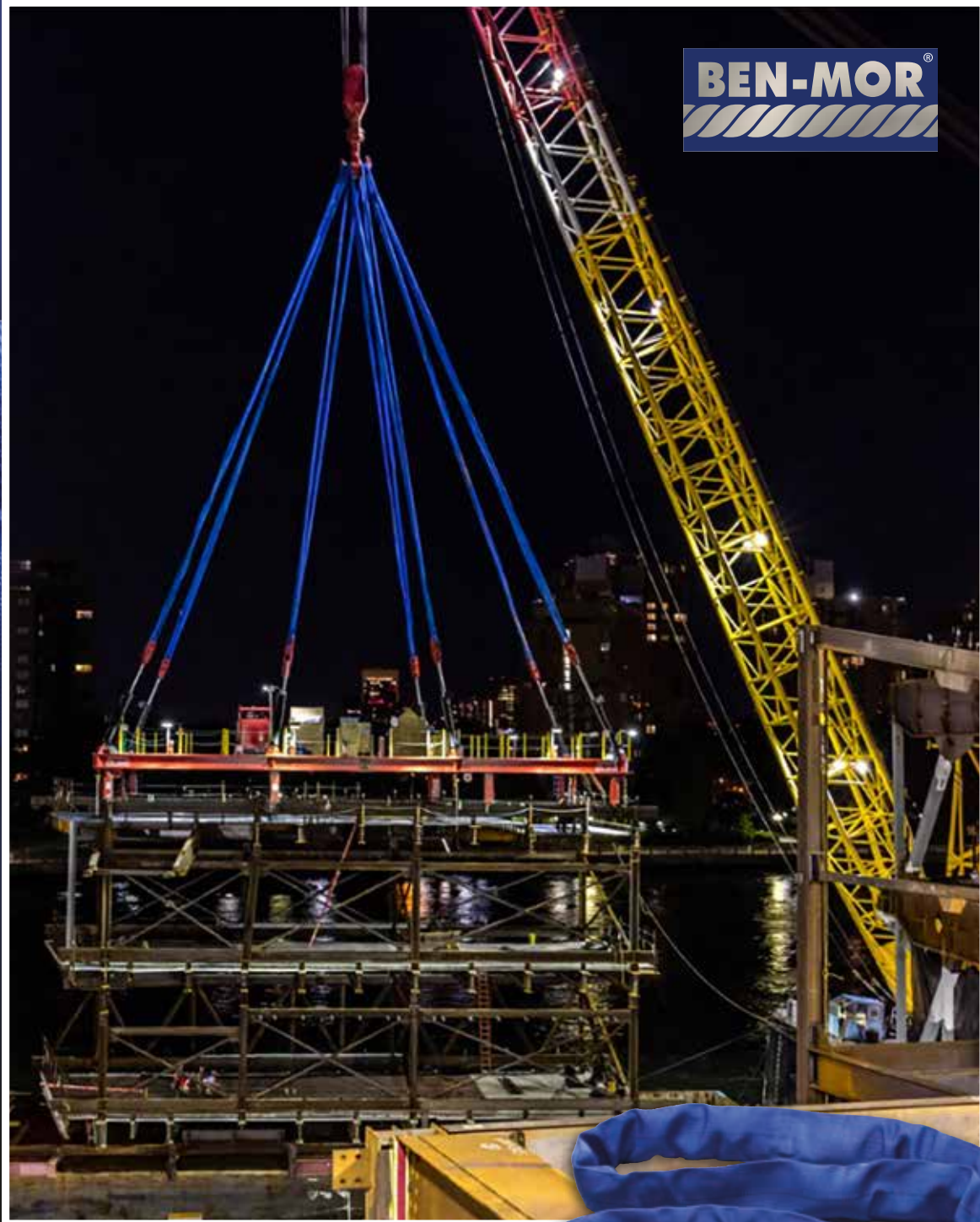

30,000 LBS
24,000 LBS
60,000 LBS



Round Sling Connection Points

Connection hardware for round slings should be selected such that bearing stress value at the connection does not exceed 7,000 lbs/in² during sling loading.

Round Sling Connection Points

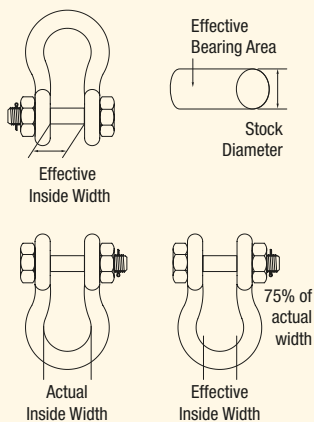

Two options :
Connection to Flat-bottom Surfaced Hardware – includes pins, bolts and trunnions. The value of the effective contact width is equal to the opening width or spread of the sling connection area.

Connection to Round-bottom Surfaced Hardware – includes links, hooks, or bow end of shackles. The value of the effective contact width is the inside opening width of the hardware multiplied by a factor of .75 equal to the opening width or spread of the sling connection area.

Load Bearing Area =

Hardware Thickness or Stock Diameter

X

Effective Contact Width

Bearing Stress =

Sling Load Value (in lbs)

÷

Load Bearing Area

Example :

A SL400, rated at 40,000 lbs in a Vertical hitch, is connected in a Vertical hitch using the rounded end of a 25 ton shackle that has a stock diameter of 2.25 inches, and an inside width of 5 inches. Is this shackle acceptable? Since the bearing surface of the shackle is rounded;

Effective Contact Width

$$= 0.75 \times \text{Inside Width (5)} = 3.75$$

Load Bearing Area

$$= \text{Shackle stock Diameter (2.25)} \times \text{Effective Width (3.75)} \\ = 8.45 \text{ in}^2$$

Bearing Stress Value

$$= \text{Vertical rating (40,000 lbs)} \div \text{Load Bearing Area (8.45 in}^2) \\ = 4,733 \text{ lbs/in}^2$$

Because the Bearing Stress Value is less than 7,000 lbs/in², this shackle is acceptable.

Tag Varieties



Custom Labeling

The company name, logo, telephone number, or any information can be put on our sling tags. The sling tag can identify a department that the rigging belongs to, a site, a crane, or an individual's name. Our custom tagging is available for any sling type. Please contact our sales department.



Wire Rope Slings, Ultra-flexible "Softflex"

Sling Diameter	Working Load Limit lbs.					
	Vertical	Choker	Basket 90°	Basket 60°	Basket 45°	Basket 30°
1/4	600	400	1,200	1,000	800	600
3/8	1,500	1,000	3,000	2,500	2,100	1,500
1/2	2,600	1,800	5,200	4,500	3,600	2,600
5/8	4,000	2,800	8,000	6,900	5,600	4,000
3/4	6,000	4,200	12,000	10,300	8,400	6,000
7/8	8,000	5,600	16,000	13,800	11,300	8,000
1	10,000	7,000	20,000	17,300	14,100	10,000
1 1/4	14,000	9,800	28,000	24,200	19,700	14,000
1 1/2	20,000	14,000	40,000	34,600	28,200	20,000
1 3/4	32,000	22,400	64,000	55,400	45,200	32,000
2	40,000	28,000	80,000	69,200	56,500	40,000

Safety Factor 5:1

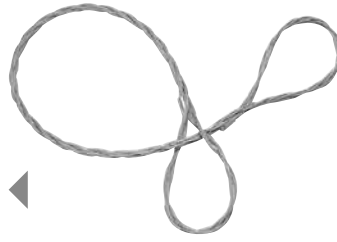

Wire Rope Slings, flexibles «Semiflex»

Sling Diameter	Working Load Limit lbs.					
	Vertical	Choker	Basket 90°	Basket 60°	Basket 45°	Basket 30°
3/8	2 000	1 500	4 000	3 400	2 800	2 000
1/2	3 400	2 500	6 800	5 800	4 800	3 400
5/8	5 200	3 900	10 400	9 000	7 300	5 200
3/4	7 200	5 400	14 400	12 400	10 100	7 200
7/8	9 800	7 300	19 600	16 900	13 800	9 800
1	12 800	9 600	25 600	22 100	18 000	12 800
1 1/8	16 000	12 000	32 000	27 700	22 600	16 000
1 1/4	19 800	14 800	39 600	34 200	27 900	19 800
1 1/2	28 000	21 000	56 000	48 400	39 500	28 000
1 3/4	38 000	28 500	76 000	65 800	53 700	38 000
2	49 600	37 200	99 200	85 900	70 100	49 600

Safety Factor 5:1





SINGLE LEG

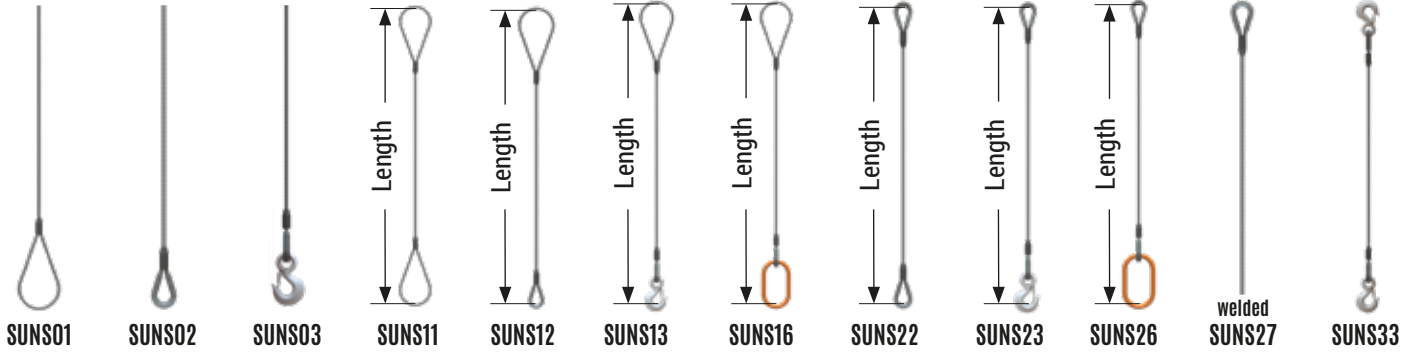

DOUBLE LEGS



THREE LEGS

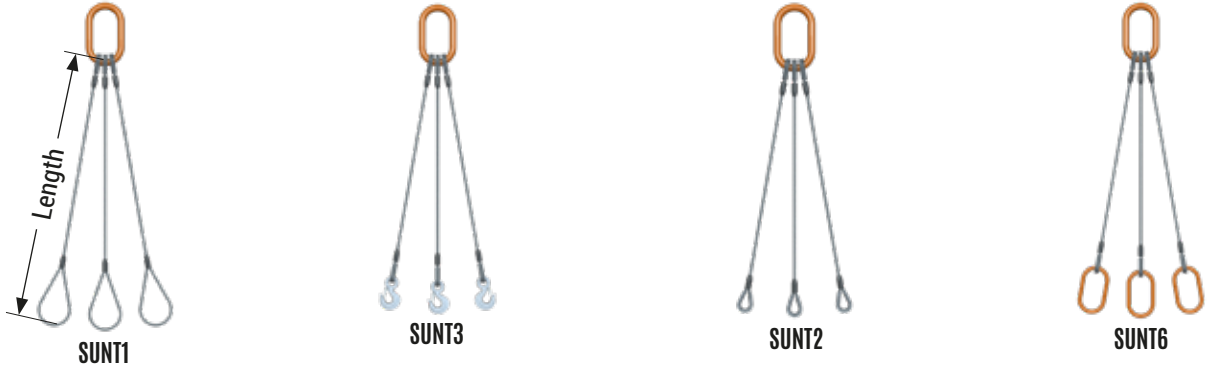

FOUR LEGS





Product code

SUN	S	22	012	003-03
Standard wire rope sling code	Nb Legs S = 1, D = 2, T = 3, Q = 4	Ends 0 = N/A, 1 = loop, 2 = thimble, 3 = hook, 4 = s409, 5 = -, 6 = Oblong, 7 = fused	Diameter	Length Feet Inches
Code, Nb legs, Ends, Diameter, Length, Feet, Inches				

Wire Rope Slings Single Leg, 6 x 19, 6 x 26, 6 x 36, 6 x 41 Steel Core EIPS

Diameter in.	Standard Loops Inside Diameter in.	TON	EIPS Working Load Limit lbs.					
			Vertical		Choker		Basket	
			90°	90°	90°	60°	45°	30°
1/4	2 x 4	1.0	1,300	960	2,600	2,200	1,820	1,300
5/16	3 x 6	1.0	2,000	1,480	4,000	3,400	2,800	2,000
3/8	3 x 6	1.5	2,800	2,200	5,800	5,000	4,000	2,800
7/16	4 x 8	2.0	3,800	2,800	7,800	6,800	5,400	3,800
1/2	4 x 8	3.0	5,000	3,800	10,200	8,800	7,200	5,000
9/16	5 x 10	5.0	6,400	4,800	12,800	10,880	8,960	6,400
5/8	5 x 10	5.0	7,800	5,800	15,600	13,600	11,000	7,800
3/4	6 x 12	7.0	11,200	8,200	22,000	19,400	15,800	11,200
7/8	7 x 14	11.0	15,200	11,200	30,000	26,000	22,000	15,200
1	8 x 16	11.0	19,600	14,400	40,000	34,000	28,000	19,600
1 1/8	9 x 18	15.0	24,000	18,200	48,000	42,000	34,000	24,000
1 1/4	10 x 20	15.0	30,000	22,000	60,000	52,000	42,000	30,000
1 3/8	11 x 22	22.0	36,000	26,000	72,000	62,000	50,000	36,000
1 1/2	12 x 24	22.0	42,000	32,000	84,000	74,000	60,000	42,000
1 3/4	14 x 28	37.0	56,000	42,000	114,000	98,000	80,000	56,000
2	16 x 32	45.0	74,000	56,000	146,000	126,000	104,000	74,000
2 1/4	18 x 36	45.0	88,000	66,000	176,000	152,000	124,000	88,000
2 1/2	20 x 40	60.0	108,000	81,000	216,000	187,000	152,000	108,000

Safety Factor 5:1

* See ring dimensions on page 67

Wire Rope Slings Double Legs, 6 x 19, 6 x 26, 6 x 36, 6 x 41 Steel Core EIPS

Diameter in.	EIPS Working Load Limit lbs.			TON	A342-XXX
	60°	45°	30°		
	1/4	2,200	1,820		
5/16	3,400	2,800	2,000	1.0	A342-058
3/8	5,000	4,000	2,800	1.5	A342-058
7/16	6,500	5,300	3,800	3.0	A342-001
1/2	8,800	7,200	5,000	3.0	A342-001
9/16	11,000	9,000	6,400	5.0	A342-001
5/8	13,600	11,000	7,800	5.0	A342-114
3/4	19,400	15,800	11,200	7.0	A342-114
7/8	26,000	22,000	15,200	11.0	A342-114
1	34,000	28,000	19,600	11.0	A342-112
1 1/8	42,000	34,000	24,000	15.0	A342-112
1 1/4	52,000	42,000	30,000	15.0	A342-134
1 3/8	62,000	50,000	36,000	22.0	A342-002
1 1/2	74,000	60,000	42,000	22.0	A342-002
1 3/4	98,000	80,000	56,000	37.0	A342-002
2	126,000	104,000	74,000	45.0	A342-214
2 1/4	152,400	124,400	88,000	45.0	A342-212
2 1/2	187,000	152,700	108,000	60.0	A342-234

Safety Factor 5:1

* See ring dimensions on page 67

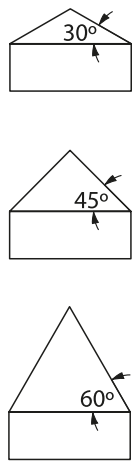

Wire Rope Slings Three Legs, 6 x 19, 6 x 26, 6 x 36, 6 x 41 Steel Core EIPS

Diameter in.	EIPS Working Load Limit lbs.			TON	A342-XXX
	60°	45°	30°		
	1/4	3,400	2,800		
5/16	5,100	4,200	3,000	1.0	A342-058
3/8	7,400	6,000	4,400	1.5	A342-001
7/16	9,800	8,000	5,700	2.0	A342-001
1/2	13,200	10,800	7,600	3.0	A342-114
9/16	16,600	13,500	9,600	5.0	A342-114
5/8	20,000	16,600	11,800	5.0	A342-114
3/4	30,000	24,000	16,800	7.0	A342-112
7/8	40,000	32,000	22,000	11.0	A342-134
1	52,000	42,000	30,000	11.0	A342-002
1 1/8	62,000	52,000	36,000	15.0	A342-214
1 1/4	76,000	62,000	44,000	15.0	A342-212
1 3/8	92,000	76,000	54,000	22.0	A342-234
1 1/2	110,000	90,000	64,000	22.0	A342-234
1 3/4	148,000	120,000	84,000	37.0	A342-234
2	190,000	156,000	110,000	45.0	A342-234
2 1/4	228,600	186,600	132,000	45.0	A342-003
2 1/2	280,500	229,000	162,000	60.0	A342-312

Safety Factor 5:1

* See ring dimensions on page 67

Wire Rope Slings Four Legs, 6 x 19, 6 x 26, 6 x 36, 6 x 41 Steel Core EIPS

Diameter in.	EIPS Working Load Limit lbs.			TON	A342-XXX
	60°	45°	30°		
	1/4	4,400	3,600		
5/16	6,900	5,600	4,000	1.0	A342-058
3/8	10,000	8,200	5,800	1.5	A342-001
7/16	13,100	10,700	7,600	2.0	A342-001
1/2	17,600	14,200	10,200	3.0	A342-114
9/16	22,100	18,000	12,800	5.0	A342-114
5/8	28,000	22,000	15,600	5.0	A342-114
3/4	38,000	32,000	22,000	7.0	A342-112
7/8	52,000	42,000	30,000	11.0	A342-134
1	68,000	56,000	40,000	11.0	A342-002
1 1/8	84,000	68,000	48,000	15.0	A342-214
1 1/4	102,000	84,000	60,000	15.0	A342-212
1 3/8	124,000	100,000	72,000	22.0	A342-234
1 1/2	146,000	120,000	84,000	22.0	A342-234
1 3/4	196,000	160,000	114,000	37.0	A342-234
2	256,300	209,200	148,000	45.0	A342-312
2 1/4	304,800	248,800	176,000	45.0	A342-334
2 1/2	374,100	305,400	216,000	60.0	A342-004

Safety Factor 5:1

* See ring dimensions on page 67

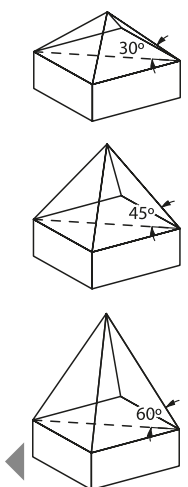

WARNING: The maximum loads shown are applicable only for new products or in perfect condition.
Do not exceed maximum rated capacities.



Proof Tested Chain Slings, meet requirements of ASME B30.9

SINGLE LEG



DOUBLE LEGS

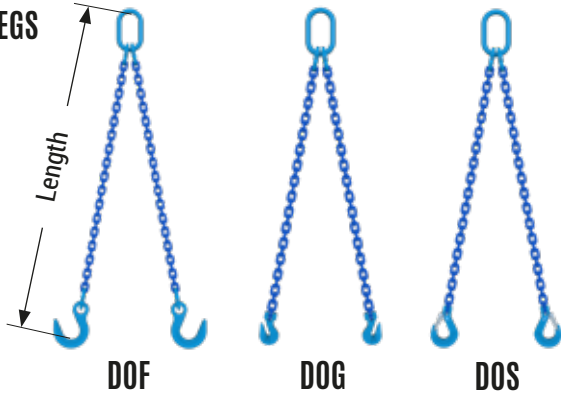

THREE LEGS

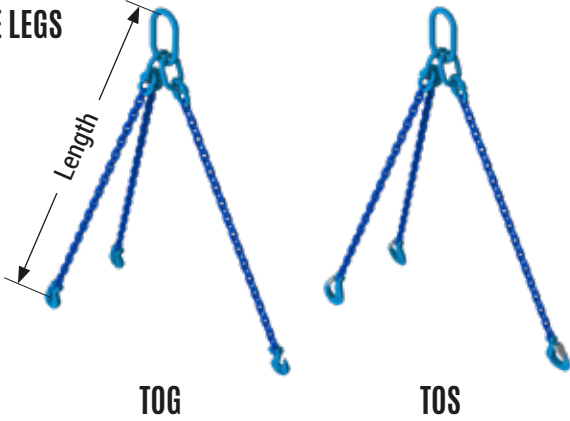

FOUR LEGS

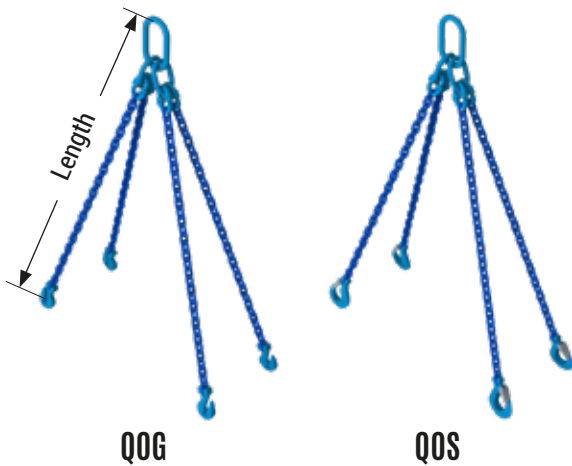

Adjustable chain slings also available



Type A

Type B



Chain Sling

Do a comparison with buying your chain slings from Ben-Mor and competition.

	BEN-MOR	COMPETITION
1	Proof test all NEW chain slings to meet requirements of ASME B30.9?	<input checked="" type="checkbox"/> <input type="checkbox"/>
2	Have ISO certification?	<input checked="" type="checkbox"/> <input type="checkbox"/>
3	Have liability insurance for manufacturing lifting slings?	<input checked="" type="checkbox"/> <input type="checkbox"/>



Ben-Mor
OFFERS DIFFERENT
CHAIN SLINGS SERVICES :

- INSPECTION
- CLEANING
- CERTIFICATION

**CERTIFIED
ISO 9001**

Environmental considerations

WARNING

Chemicals & Acids

Alloy chain, Grade 80 and Grade 100 components must not be used in acidic conditions.

Extreme temperature conditions

The temperature affects the Working Load Limit of Grade 80 and Grade 100 chain slings as shown in the chart beside. Grade 80 and Grade 100 alloy chain slings must not be used at temperatures outside the ranges in the chart beside.

Use

Never make knots with a lifting sling ;
Do not exceed specified Working Load Limit (WLL).

Product code

D	O	S	80	012	003-03	
Number of Legs S = 1, D = 2 T = 3, Q = 4	1 st End	2 nd End	Adjustable Type A = Type A, B = Type B	Grade 100 = Grade 100, 80 = Grade 80	Diameter (inches)	Length (feet)

ASME B30.9-2021

Effect of temperature on rated load of alloy steel chain

Temperature		Grade 80		Grade 100	
°F	°C	Temporary Reduction of Rated Load While at Temperature	Permanent Reduction of Rated Load After Exposure to Temperature	Temporary Reduction of Rated Load While at Temperature	Permanent Reduction of Rated Load After Exposure to Temperature
< -40	< -40	not-recommended	n/a	not-recommended	n/a
-40 à 400	-40 à 400	0%	None	0%	None
400	204	10%	None	15%	None
500	260	15%	None	25%	5%
600	316	20%	5%	30%	15%
700	371	30%	10%	40%	20%
800	427	40%	15%	50%	25%
900	482	50%	20%	60%	30%
1,000	538	60%	25%	70%	35%
> 1,000	> 538	Note ¹	Note ¹	Note ¹	Note ¹

Note ¹ : Remove from service.

Grade 100

Proof Tested & Certified Chain Slings – Grade 100

Chain Diameter in.	Working Load Limit (lbs.)				GRADE 100 Oblong* Master Link	
	Single Leg 90°	Double Legs 60°	Double Legs 45°	Double Legs 30°	Single	Double
9/32	4,300	7,400	6,100	4,300	A342-012G100BM	A342-058G100BM
5/16	5,700	9,900	8,100	5,700	A342-012G100BM	A342-058G100BM
3/8	8,800	15,200	12,400	8,800	A342-034G100BM	A342-078G100BM
1/2	15,000	26,000	21,200	15,000	A342-001G100BM	A342-001G100BM
5/8	22,600	39,100	32,000	22,600	A342-001G100BM	A342-114G100BM
3/4	35,300	61,100	49,900	35,300	A342-114G100BM	A342-112G100BM
7/8	42,700	74,000	60,400	42,700	A342-112G100BM	A342-134G100BM

Safety Factor 4:1

* See ring dimensions on page 63

Chain Diameter in.	Working Load Limit (lbs.)			GRADE 100 Oblong* Assemblies
	Three/Four Legs 60°	Three/Four Legs 45°	Three/Four Legs 30°	
9/32	11,200	9,100	6,400	SUB-034G100BM
5/16	14,800	12,100	8,500	SUB-001G100BM
3/8	22,900	18,700	13,200	SUB-001G100BM
1/2	39,000	31,800	22,500	SUB-114G100BM
5/8	58,700	47,900	33,900	SUB-112G100BM
3/4	91,700	74,900	53,000	SUB-002G100BM
7/8	110,900	90,600	64,000	SUB-212G100BM

Safety Factor 4:1

* See ring dimensions on page 63

Alloy Lifting Chains Grade 100 (blue cataphoresis)

Code	Diameter in.	Working Load Limit lbs.	Weight / 100 ft. lbs.	Dimensions in.		
				A	B	D
CH100-932	9/32	4,300	77	0.87	0.41	0.28
CH100-516	5/16	5,700	112	1.01	0.48	0.34
CH100-038	3/8	8,800	152	1.23	0.56	0.40
CH100-012	1/2	15,000	279	1.57	0.75	0.53
CH100-058	5/8	22,600	374	1.93	0.87	0.63
CH100-034	3/4	35,300	600	2.42	1.13	0.82
CH100-078	7/8	42,700	793	2.66	1.26	0.91
CH100-001	1	59,700	1,010	3.09	1.42	1.03

Safety Factor 4:1

Meet NACM and ASTM 973 standards.

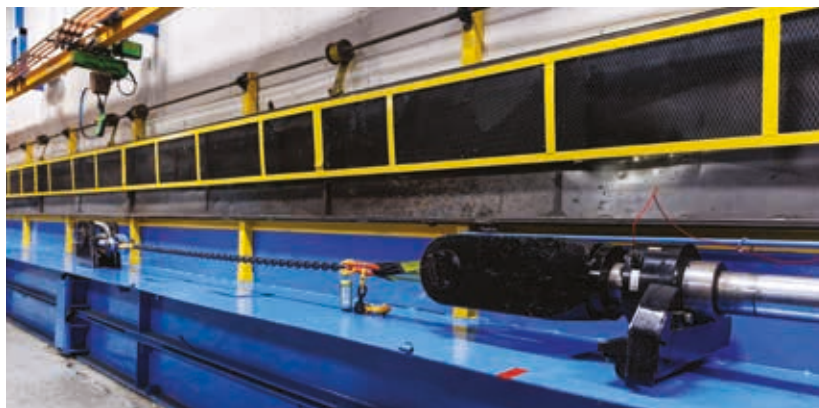
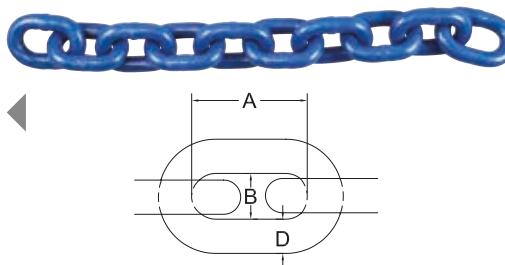

WARNING: The maximum loads shown are applicable only for new products or in perfect condition.

! Do not exceed maximum rated capacities.



Grade 100

Master Oblong Links (Gr. 100 - alloy steel, quenched and tempered)

Code	Working Load Limit lbs.	Weight / each lbs.	Dimensions in.					
			A		B		D	
			Min	Max	Min	Max	Min	Max
A342-012G100BM	7,400	0.8	4.764	5.236	2.303	2.697	0.472	0.551
A342-058G100BM	8,800	1.5	5.748	6.220	2.795	3.189	0.591	0.669
A342-034G100BM	12,300	2.0	5.276	5.748	2.559	2.953	0.709	0.787
A342-078G100BM	15,200	3.3	6.063	6.535	3.346	3.740	0.827	0.906
A342-001G100BM	26,000	4.6	6.772	7.244	3.307	3.701	0.945	1.024
A342-114G100BM	39,000	9.3	8.465	9.016	4.134	4.606	1.181	1.299
A342-112G100BM	61,000	15.8	10.236	10.787	5.079	5.551	1.417	1.535
A342-134G100BM	84,800	25.4	11.614	12.012	5.748	6.220	1.693	1.811
A342-002G100BM	102,500	37.8	13.583	14.370	6.772	7.244	1.929	2.047
A342-214G100BM	143,000	53.9	15.591	16.378	7.717	8.268	2.165	2.283
A342-212G100BM	160,000	68.0	15.591	16.378	7.717	8.268	2.382	2.618
A342-234G100BM	216,900	86.9	15.591	16.378	9.213	9.764	2.638	2.874

Safety Factor 5:1

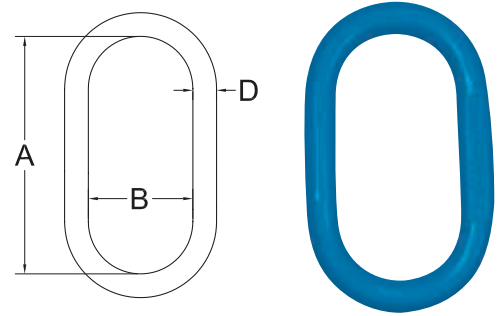

Stamped with BM identification code, size, grade and traceability code. Meet ASTM standard.

Welded Master Link Assemblies (Gr. 100 - alloy steel, quenched and tempered)

Code	Working Load Limit lbs.	Weight / each lbs.	Dimensions in.											
			A1		B1		D1		A2		B2		D2	
			Min	Max	Min	Max	Min	Max	Min	Max	Min	Max	Min	Max
SUB-012G100BM	7,400	1.0	3.740	4.134	2.165	2.559	0.512	0.591	3.150	3.543	1.457	1.693	0.433	0.512
SUB-034G100BM	12,300	3.4	5.315	5.709	2.559	2.953	0.748	0.827	3.150	3.543	1.457	1.693	0.512	0.591
SUB-001G100BM	26,000	7.2	6.102	6.496	3.543	3.937	0.827	0.906	3.150	3.543	1.457	1.693	0.512	0.591
SUB-114G100BM	39,000	15.8	8.465	8.858	4.134	4.528	1.220	1.299	3.740	4.134	2.244	2.480	0.827	0.906
SUB-112G100BM	61,000	28.4	10.303	10.697	5.053	5.447	1.461	1.539	6.803	7.197	3.882	4.118	1.148	1.227
SUB-134G100BM	84,800	46.8	11.811	12.205	5.787	6.181	1.732	1.811	6.890	7.283	3.819	4.055	1.220	1.299
SUB-002G100BM	102,500	66.7	13.819	14.213	6.811	7.205	1.929	2.008	6.890	7.283	3.819	4.055	1.457	1.535
SUB-212G100BM	160,000	141.7	15.787	16.181	7.795	8.189	2.480	2.559	13.780	14.173	6.890	7.126	1.929	2.008
SUB-234G100BM	216,900	207.0	15.787	16.181	9.291	9.685	2.717	2.795	15.787	16.181	7.874	8.110	2.323	2.402

Safety Factor 5:1

Stamped with BM identification code, size, grade and traceability code. Meet ASTM standard.

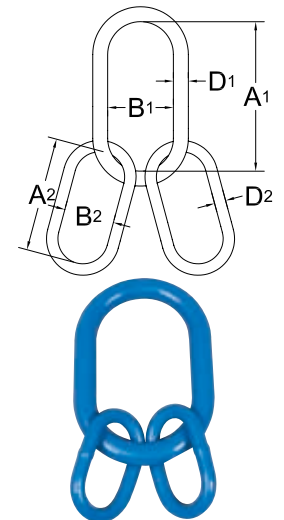

Safety Latch Kit (Gr. 100, for sling hooks)

Code	For Chain Size in.	Weight / each lbs.
LATCHGR1007/32BM	7/32	0.07
LATCHGR1009/32BM	9/32	0.09
LATCHGR1003/8BM	3/8	0.14
LATCHGR1001/2BM	1/2	0.30
LATCHGR1005/8BM	5/8	0.33
LATCHGR1003/4BM	3/4	0.51
LATCHGR1007/8BM	7/8	0.72
LATCHGR1001BM	1	0.90
LATCHGR10011/4BM	1 1/4	1.44

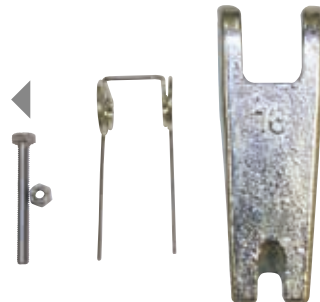

Latch Kit Trigger (Gr. 80 et Gr. 100, for self locking hooks)

Code	For Chain Size in.	Weight / each lbs.
LATCHTRG732	7/32	0.04
LATCHTRG932	9/32	0.05
LATCHTRG038	3/8	0.052
LATCHTRG012	1/2	0.104
LATCHTRG058	5/8	0.2



WARNING: The maximum loads shown are applicable only for new products or in perfect condition.

WARNING: Do not exceed maximum rated capacities.

Clevis Sling Hooks with latch* (Gr. 100 - Alloy steel, quenched and tempered)

Code	Marking	For Chain Size in.	Working Load Limit lbs.	Weight / each lbs.	Dimensions in.								
					B	C	E	F	H	K	L	M	N
CSH100L-732BM	6-10	7/32	3,100	0.73	0.295 ± 0.020	2.697 ± 0.079	4.291 ± 0.079	2.874 ± 0.079	0.669 ± 0.079	1.260 ± 0.059	0.709 ^{+0.039} _{-0.079}	0.827 ± 0.039	0.650 ± 0.039
CSH100L-932BM	8-10	9/32 - 5/16	5,700	1.32	0.374 ± 0.020	3.465 ± 0.079	5.276 ± 0.079	3.484 ± 0.079	0.906 ± 0.079	1.457 ± 0.059	0.945 ^{+0.039} _{-0.079}	1.083 ± 0.039	0.669 ± 0.039
CSH100L-038BM	10-10	3/8	8,800	2.86	0.492 ± 0.020	4.016 ± 0.079	6.299 ± 0.118	4.134 ± 0.118	1.142 ± 0.079	1.890 ± 0.059	1.181 ^{+0.039} _{-0.079}	1.260 ± 0.079	0.945 ± 0.059
CSH100L-012BM	13-10	1/2	15,000	5.06	0.591 ± 0.039	5.276 ± 0.118	7.992 ± 0.118	5.197 ± 0.118	1.496 ± 0.079	2.323 ± 0.059	1.575 ^{+0.039} _{-0.079}	1.654 ± 0.079	1.339 ± 0.059
CSH100L-058BM	16-10	5/8	22,600	7.92	0.728 ± 0.039	6.319 ± 0.118	9.764 ± 0.118	6.339 ± 0.118	1.811 ± 0.118	2.756 ± 0.079	1.969 ^{+0.039} _{-0.079}	1.969 ± 0.079	1.496 ± 0.059
CSH100L-034BM	20-10	3/4	35,300	16.06	0.984 ± 0.039	7.500 ± 0.118	11.693 ± 0.157	7.756 ± 0.157	1.969 ± 0.118	3.346 ± 0.079	2.087 ^{+0.039} _{-0.079}	2.205 ± 0.079	1.890 ± 0.059
CSH100L-078BM	22-10	7/8	42,700	26.62	1.063 ± 0.039	8.445 ± 0.118	12.835 ± 0.157	8.425 ± 0.157	2.559 ± 0.118	3.937 ± 0.079	2.677 ^{+0.039} _{-0.118}	2.441 ± 0.118	1.969 ± 0.059
CSH100L-001BM	26-10	1	59,700	35.42	1.201 ± 0.079	9.764 ± 0.157	15.079 ± 0.197	9.724 ± 0.197	2.835 ± 0.118	4.646 ± 0.118	2.992 ± 0.118	2.874 ± 0.118	2.362 ± 0.079
CSH100L-114BM	32-10	1 1/4	90,400	59.84	1.476 ± 0.079	- ± 0.157	18.661 ± 0.197	12.205 ± 0.197	3.425 ± 0.157	5.866 ± 0.118	3.189 ± 0.118	3.425 ± 0.118	2.795 ± 0.079

Safety Factor 4:1

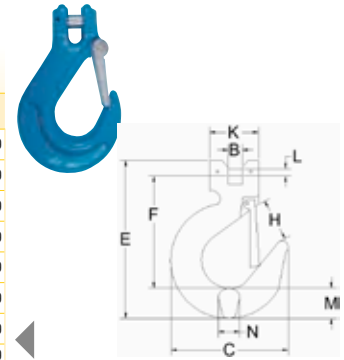

Stamped with BM identification code, size, grade and traceability code. Meet ASTM-952 standard.

* Replacement safety latch kit available. See on page 63.

Eye Foundry Hooks (Gr. 100 - Alloy steel, quenched and tempered)

Code	Marking	For Chain Size in.	Working Load Limit lbs.	Weight / each lbs.	Dimensions in.							
					C	D	E	F	G	H	M	N
EFH100-732BM	6-10	7/32	3,100	0.84	3.937 ± 0.079	0.394 ± 0.039	5.197 ± 0.441	4.055 ± 0.370	0.787 ^{+0.020} _{-0.039}	1.929 ^{+0.039} _{-0.079}	0.748 ± 0.031	0.669 ± 0.031
EFH100-932BM	8-10	9/32 - 5/16	5,700	1.56	5.039 ± 0.079	0.472 ± 0.039	6.283 ± 0.441	4.748 ± 0.370	0.945 ^{+0.020} _{-0.039}	2.441 ^{+0.039} _{-0.079}	1.063 ± 0.031	0.748 ± 0.031
EFH100-038BM	10-10	3/8	8,800	2.99	6.004 ± 0.098	0.591 ± 0.039	7.795 ± 0.469	6.024 ± 0.370	1.240 ^{+0.020} _{-0.039}	2.874 ^{+0.079} _{-0.118}	1.181 ± 0.059	0.984 ± 0.039
EFH100-012BM	13-10	1/2	15,000	5.65	7.205 ± 0.098	0.748 ± 0.039	9.449 ± 0.561	7.165 ± 0.463	1.732 ^{+0.039} _{-0.079}	3.543 ^{+0.079} _{-0.118}	1.535 ± 0.059	1.299 ± 0.039
EFH100-058BM	16-10	5/8	22,600	8.71	8.583 ± 0.118	0.866 ± 0.079	11.024 ± 0.620	8.504 ± 0.463	1.929 ^{+0.039} _{-0.079}	4.134 ^{+0.079} _{-0.157}	1.654 ± 0.079	1.457 ± 0.079
EFH100-034BM	20-10	3/4	35,300	16.06	9.882 ± 0.118	1.024 ± 0.079	12.992 ± 0.713	9.724 ± 0.556	2.362 ^{+0.039} _{-0.079}	4.488 ^{+0.079} _{-0.157}	2.244 ± 0.079	1.811 ± 0.079
EFH100-078BM	22-10	7/8	42,700	25.08	10.787 ± 0.157	1.220 ^{+0.157} _{-0.079}	14.803 ± 1.016	10.827 ± 0.741	2.520 ± 0.079	4.843 ^{+0.079} _{-0.157}	2.756 ± 0.118	2.362 ± 0.157
EFH100-001BM	26-10	1	59,700	38.94	12.598 ± 0.157	1.378 ± 0.098	16.417 ± 0.957	11.811 ± 0.741	2.756 ± 0.098	5.512 ± 0.098	3.228 ± 0.118	2.677 ± 0.098

Safety Factor 4:1

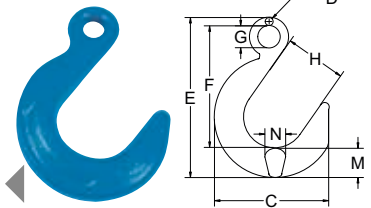

Stamped with BM identification code, size, grade and traceability code. Meet ASTM-952 standard.

Eye Self Locking Hooks* (Gr. 100 - Alloy steel, quenched and tempered)

Code	Marking	For Chain Size in.	Working Load Limit lbs.	Weight / each lbs.	Dimensions in.						
					C	D	F	G	H _{min}	M	N
S316-732G100BM	6-10	7/32	3,100	1.1	2.874 ± 0.079	0.433 ± 0.039	4.331 ± 0.157	0.827 ± 0.039	1.102	0.787 ± 0.157	0.591 ± 0.039
S316-014G100BM	8-10	1/4 - 5/16	5,700	2.0	3.543 ± 0.118	0.472 ± 0.039	5.394 ± 0.157	1.063 ± 0.039	1.417	1.024 ± 0.157	0.787 ± 0.039
S316-038G100BM	10-10	3/8	8,800	3.3	4.252 ± 0.118	0.591 ± 0.039	6.693 ± 0.197	1.358 ± 0.079	1.772	1.063 ± 0.197	1.024 ± 0.079
S316-012G100BM	13-10	1/2	15,000	5.9	5.413 ± 0.157	0.787 ± 0.079	8.228 ± 0.197	1.575 ± 0.079	2.110	1.575 ± 0.197	1.280 ± 0.079
S316-058G100BM	16-10	5/8	22,600	18.9	6.713 ± 0.157	1.063 ± 0.079	10.079 ± 0.236	1.969 ± 0.118	2.402	1.969 ± 0.236	1.496 ± 0.118
S316-034G100BM	20-10	3/4	35,300	17.4	7.539 ± 0.197	1.181 ± 0.079	10.906 ± 0.236	2.362 ± 0.118	3.012	2.421 ± 0.236	1.969 ± 0.118
S316-078G100BM	22-10	7/8	42,700	24.6	8.071 ± 0.197	1.299 ± 0.079	12.559 ± 0.315	2.756 ± 0.118	3.150	2.559 ± 0.315	2.047 ± 0.118
S316-001G100BM	26-10	1	59,700	45.1	9.882 ± 0.197	1.496 ± 0.079	14.567 ± 0.315	2.992 ± 0.118	3.898	3.189 ± 0.315	2.362 ± 0.118
S316-114G100BM	32-10	1 1/4	90,400	88.8	12.953 ± 0.197	1.969 ± 0.079	18.465 ± 0.315	3.740 ± 0.118	5.315	3.976 ± 0.315	2.953 ± 0.118

Safety Factor 4:1

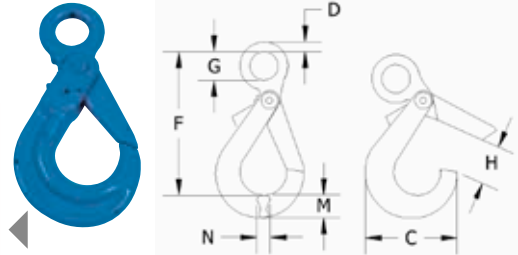

Stamped with BM identification code, size, grade and traceability code. Meet ASTM-952 standard.

* Replacement latch kit trigger available. See on page 63.

Clevis Self Locking Hooks* (Gr. 100 - Alloy steel, quenched and tempered)

Code	Marking	For Chain Size in.	Working Load Limit lbs.	Weight / each lbs.	Dimensions in.							
					B	C	E	F	H _{min}	K	L	N
S317-732G100BM	6-10	7/32	3,100	1.1	0.315 ± 0.020	2.874 ± 0.079	5.157 ± 0.157	3.780 ± 0.157	1.102	1.260 ± 0.059	0.299 ± 0.004	0.591 ± 0.039
S317-014G100BM	8-10	1/4 - 5/16	5,700	2.0	0.374 ± 0.020	3.543 ± 0.079	6.417 ± 0.157	4.764 ± 0.157	1.417	1.417 ± 0.059	0.386 ± 0.004	0.787 ± 0.039
S317-038G100BM	10-10	3/8	8,800	3.1	0.472 ± 0.020	4.252 ± 0.118	7.638 ± 0.197	5.669 ± 0.197	1.772	1.811 ± 0.059	0.512 ± 0.004	1.024 ± 0.059
S317-012G100BM	13-10	1/2	15,000	6.4	0.591 ± 0.039	5.394 ± 0.118	9.882 ± 0.197	7.165 ± 0.197	2.110	2.323 ± 0.059	0.622 ± 0.004	1.280 ± 0.059
S317-058G100BM	16-10	5/8	22,600	12.1	0.728 ± 0.039	6.614 ± 0.118	11.929 ± 0.236	8.661 ± 0.236	2.402	2.756 ± 0.079	0.768 ± 0.004	1.496 ± 0.079
S317-034G100BM	20-10	3/4	35,300	18.7	0.984 ± 0.059	7.480 ± 0.118	13.268 ± 0.276	9.252 ± 0.276	3.012	3.346 ± 0.079	0.945 ± 0.004	1.969 ± 0.118
S317-078G100BM	22-10	7/8	42,700	20.2	1.004 ± 0.079	7.953 ± 0.157	15.197 ± 0.315	10.669 ± 0.315	3.150	3.858 ± 0.098	1.102 ± 0.004	2.047 ± 0.118
S317-001G100BM	26-10	1	59,700	26.6	1.181 ± 0.079	9.882 ± 0.157	19.055 ± 0.315	13.504 ± 0.315	3.898	4.646 ± 0.098	1.319 ± 0.004	2.362 ± 0.118
S317-114G100BM	32-10	1 1/4	90,400	46.5	1.378 ± 0.079	12.953 ± 0.157	23.661 ± 0.315	16.654 ± 0.315	5.315	5.906 ± 0.098	1.602 ± 0.004	2.953 ± 0.118

Safety Factor 4:1

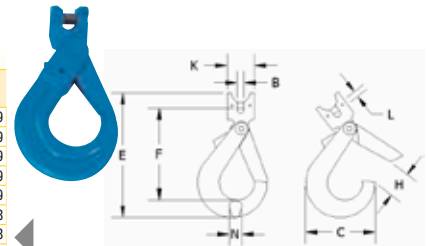

Stamped with BM identification code, size, grade and traceability code. Meet ASTM-952 standard.

* Replacement latch kit trigger available. See on page 63.

Swivel Self Locking Hooks* (Gr. 100 - Alloy steel, quenched and tempered)

Code	Marking	For Chain Size in.	Working Load Limit lbs.	Weight / each lbs.	Dimensions in.							
					C	D	E	F	H _{min}	I	J	N
S326-732G100BM	6-10	7/32	3,100	1.3	2.874 ± 0.079	0.453 ± 0.039	7.244 ± 0.197	6.004 ± 0.157	1.102	1.004 ± 0.079	1.280 ± 0.079	0.591 ± 0.039
S326-014G100BM	8-10	1/4 - 5/16	5,700	2.4	3.543 ± 0.118	0.512 ± 0.039	8.898 ± 0.236	7.402 ± 0.157	1.417	1.122 ± 0.079	1.417 ± 0.079	0.787 ± 0.039
S326-038G100BM	10-10	3/8	8,800	4.4	4.252 ± 0.118	0.610 ± 0.039	10.991 ± 0.236	8.878 ± 0.197	1.772	1.378 ± 0.118	1.654 ± 0.118	1.024 ± 0.079
S326-012G100BM	13-10	1/2	15,000	8.8	5.413 ± 0.157	0.669 ± 0.079	12.874 ± 0.276	10.630 ± 0.197	2.110	1.614 ± 0.118	1.969 ± 0.118	1.280 ± 0.079
S326-058G100BM	16-10	5/8	22,600	15.0	6.713 ± 0.157	0.846 ± 0.079	16.260 ± 0.276	13.465 ± 0.236	2.402	2.283 ± 0.157	2.756 ± 0.157	1.496 ± 0.118
S326-034G100BM	20-10	3/4	35,300	27.5	7.539 ± 0.197	1.024 ± 0.079	18.110 ± 0.315	14.685 ± 0.236	3.012	2.480 ± 0.157	2.835 ± 0.157	1.969 ± 0.118
S326-078G100BM	22-10	7/8	42,700	37.6	8.071 ± 0.197	1.299 ± 0.079	22.283 ± 0.315	18.425 ± 0.276	3.150	3.780 ± 0.197	3.819 ± 0.197	2.047 ± 0.118
S326-001G100BM	26-10	1	59,700	68.6	9.882 ± 0.197	1.654 ± 0.079	27.047 ± 0.315	22.244 ± 0.276	3.898	4.685 ± 0.197	4.843 ± 0.197	2.362 ± 0.118
S326-114G100BM	32-10	1 1/4	90,400	131.8	12.953 ± 0.197	2.047 ± 0.079	32.835 ± 0.315	26.772 ± 0.276	5.315	5.669 ± 0.197	5.512 ± 0.197	2.953 ± 0.118

Safety Factor 4:1

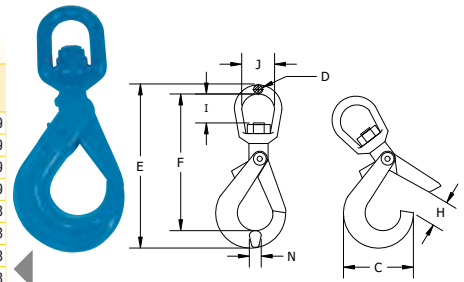

Stamped with BM identification code, size, grade and traceability code. Meet ASTM-952 standard.

* Replacement latch kit trigger available. See on page 63.



Swivel Self Locking Hooks with bearing* (Gr. 100 - Alloy steel, quenched and tempered)

Code	For Chain Size in.	Working Load Limit lbs.	Weight / each lbs.	Dimensions in.						
				C ± 0.118	D ± 0.020	F ± 0.118	H ± 0.039	I ± 0.039	J ± 0.039	N ± 0.078
S326BEA-732G100BM	7/32	3,100	1.47	2.80	0.53	6.42	1.18	1.38	1.28	0.59
S326BEA-014G100BM	1/4 - 5/16	5,700	2.66	3.54	0.59	7.99	1.50	1.57	1.61	0.85
S326BEA-038G100BM	3/8	8,800	4.84	4.25	0.69	9.61	1.89	2.01	1.89	1.00
S326BEA-012G100BM	1/2	15,000	9.68	5.43	0.75	11.61	2.48	2.32	2.17	1.26
S326BEA-058G100BM	5/8	22,600	16.46	6.69	1.02	13.70	2.95	2.60	2.40	1.50
S326BEA-034G100BM	3/4	35,300	30.25	7.52	1.12	15.71	3.15	2.99	2.99	1.97
S326BEA-078G100BM	7/8	42,700	41.38	8.19	1.30	18.46	3.74	3.94	3.82	2.05

Safety Factor 4:1

* Replacement latch kit trigger available. See on page 63.

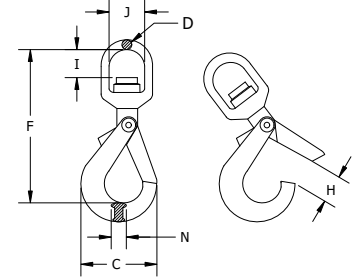

Stamped with BM identification code, size, grade and traceability code. Meet ASTM-952 standard. With ball bearing, which performs full swivel under load

Clevis Cradle Grab Hooks (Gr. 100, alloy steel, quenched and tempered)

Code	Marking	For Chain Size in.	Working Load Limit lbs.	Weight / each lbs.	Dimensions in.								
					B	C	E	F	H	K	L	N	T
CGH100-732BM	6-10	7/32	3,100	0.48	0.295 ± 0.020	1.831 ± 0.079	3.043 ± 0.079	1.752 ± 0.118	0.315 ± 0.039	1.260 ± 0.059	0.299 ± 0.008	1.004 ± 0.059	0.709 ± 0.039
CGH100-932BM	8-10	9/32 - 5/16	5,700	0.75	0.374 ± 0.020	2.126 ± 0.079	3.661 ± 0.118	2.087 ± 0.118	0.433 ± 0.039	1.417 ± 0.059	0.386 ± 0.008	1.319 ± 0.059	0.945 ± 0.059
CGH100-038BM	10-10	3/8	8,800	1.80	0.492 ± 0.020	2.835 ± 0.079	5.000 ± 0.118	2.874 ± 0.118	0.531 ± 0.059	1.811 ± 0.059	0.512 ± 0.008	1.654 ± 0.079	1.161 ± 0.059
CGH100-012BM	13-10	1/2	15,000	3.85	0.591 ± 0.039	3.780 ± 0.079	6.457 ± 0.157	3.622 ± 0.157	0.591 ± 0.059	2.323 ± 0.059	0.622 ± 0.008	2.106 ± 0.079	1.457 ± 0.059
CGH100-058BM	16-10	5/8	22,600	6.34	0.728 ± 0.039	4.528 ± 0.118	7.402 ± 0.157	4.055 ± 0.157	0.748 ± 0.059	2.756 ± 0.079	0.768 ± 0.008	2.913 ± 0.098	1.811 ± 0.079
CGH100-034BM	20-10	3/4	35,300	10.65	0.945 ± 0.059	5.709 ± 0.118	8.780 ± 0.197	4.843 ± 0.197	0.984 ± 0.079	3.346 ± 0.079	0.945 ± 0.008	3.425 ± 0.098	2.047 ± 0.079
CGH100-078BM	22-10	7/8	42,700	18.26	1.063 ± 0.079	6.260 ± 0.118	10.236 ± 0.197	5.551 ± 0.197	1.063 ± 0.079	3.937 ± 0.098	1.102 ± 0.008	3.543 ± 0.118	2.402 ± 0.098
CGH100-001BM	26-10	1	59,700	30.18	1.181 ± 0.079	7.480 ± 0.157	12.598 ± 0.197	7.362 ± 0.197	1.339 ± 0.079	4.331 ± 0.098	1.319 ± 0.008	4.331 ± 0.118	2.756 ± 0.098
CGH100-114BM	32-10	1 1/4	90,400	56.10	1.378 ± 0.079	9.016 ± 0.157	14.882 ± 0.197	8.386 ± 0.197	1.614 ± 0.079	5.906 ± 0.098	1.602 ± 0.008	5.118 ± 0.118	3.150 ± 0.098

Safety Factor 4:1

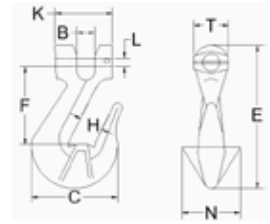

Stamped with BM identification code, size, grade and traceability code. Meet ASTM-952 standard.

Eye Sling Hooks with latch* (Gr. 100, alloy steel, quenched and tempered)

Code	Marking	For Chain Size in.	Working Load Limit lbs.	Weight / each lbs.	Dimensions po						
					C	D	E	F	G	H	T
ESH100L-732BM	6-10	7/32	3,100	0.70	2.677 ^{+0.039} _{-0.079}	0.394 ± 0.020	4.370 ± 0.079	3.150 ± 0.079	0.807 ± 0.039	0.728 ± 0.039	0.650 ± 0.039
ESH100L-932BM	8-10	9/32 - 5/16	5,700	1.32	3.425 ^{+0.039} _{-0.079}	0.433 ± 0.020	5.394 ± 0.079	3.898 ± 0.079	0.984 ± 0.039	0.984 ± 0.079	0.669 ± 0.039
ESH100L-038BM	10-10	3/8	8,800	2.20	4.134 ^{+0.039} _{-0.118}	0.630 ± 0.031	6.693 ± 0.118	4.724 ± 0.118	1.260 ± 0.039	1.161 ± 0.079	0.945 ± 0.079
ESH100L-012BM	13-10	1/2	15,000	4.84	5.433 ^{+0.000} _{-0.118}	0.748 ± 0.031	8.622 ± 0.118	6.161 ± 0.118	1.693 ± 0.079	1.496 ± 0.079	1.299 ± 0.079
ESH100L-058BM	16-10	5/8	22,600	7.70	6.220 ^{+0.039} _{-0.118}	0.965 ± 0.039	10.236 ± 0.118	7.303 ± 0.118	2.008 ± 0.079	1.811 ± 0.079	1.575 ± 0.079
ESH100L-034BM	20-10	3/4	35,300	13.64	7.480 ^{+0.039} _{-0.118}	1.063 ± 0.039	11.732 ± 0.157	8.465 ± 0.157	2.165 ± 0.079	1.969 ± 0.118	1.890 ± 0.079
ESH100L-078BM	22-10	7/8	42,700	17.60	8.425 ^{+0.079} _{-0.157}	1.142 ± 0.039	12.992 ± 0.157	9.409 ± 0.157	2.362 ± 0.079	2.520 ± 0.118	1.969 ± 0.098
ESH100L-001BM	26-10	1	59,700	29.92	9.646 ^{+0.079} _{-0.157}	1.378 ± 0.079	14.803 ± 0.157	10.433 ± 0.157	2.756 ± 0.098	2.756 ± 0.118	2.362 ± 0.098
ESH100L-114BM	32-10	1 1/4	90,400	47.08	10.630 ^{+0.079} _{-0.157}	1.535 ± 0.079	18.031 ± 0.197	13.031 ± 0.197	3.209 ± 0.098	3.228 ± 0.118	2.795 ± 0.098

Safety Factor 4:1

* Replacement latch kit available. See on page 63. Latch kit available.

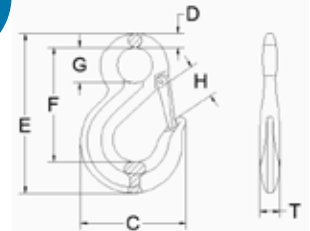

Stamped with BM identification code, size, grade and traceability code. Meet ASTM-952 standard.

Hammerlock Type Connecting Links (Gr. 100, alloy steel, quenched and tempered)

Code	Marking	For Chain Size in.	Working Load Limit lbs.	Weight / each lbs.	Dimensions po				
					A	B	D	E	T
A337-732G100BM	6-10	7/32	3,100	0.18	1.752 ± 0.098	0.551 ± 0.031	0.276 ± 0.020	2.421 ± 0.161	0.472 ^{+0.020} _{-0.039}
A337-932G100BM	7/8-10	9/32	4,300	0.37	2.323 ± 0.118	0.728 ± 0.031	0.335 ± 0.031	3.189 ± 0.181	0.610 ^{+0.020} _{-0.039}
A337-516G100BM	8-10	5/16	5,700	0.40	2.480 ± 0.118	0.728 ± 0.031	0.394 ± 0.031	3.307 ± 0.181	0.551 ^{+0.020} _{-0.039}
A337-038G100BM	10-10	3/8	8,800	0.75	2.795 ± 0.118	0.906 ± 0.039	0.496 ± 0.039	3.787 ± 0.197	0.709 ^{+0.031} _{-0.039}
A337-012G100BM	13-10	1/2	15,000	1.50	3.642 ± 0.118	1.102 ± 0.039	0.650 ± 0.039	4.941 ± 0.197	0.906 ^{+0.031} _{-0.039}
A337-058G100BM	16-10	5/8	22,600	2.68	4.193 ± 0.118	1.319 ± 0.039	0.787 ± 0.039	5.768 ± 0.197	1.161 ± 0.039
A337-034G100BM	20-10	3/4	35,300	4.69	4.843 ± 0.118	1.654 ± 0.039	0.984 ± 0.059	6.811 ± 0.236	1.398 ± 0.059
A337-078G100BM	22-10	7/8	42,700	6.60	5.413 ± 0.118	1.890 ± 0.039	1.063 ± 0.059	7.539 ± 0.236	1.535 ± 0.079
A337-001G100BM	26-10	1	59,700	11.48	6.417 ± 0.157	2.402 ± 0.079	1.260 ± 0.079	8.937 ± 0.315	1.772 ± 0.098
A337-114G100BM	32-10	1 1/4	90,400	21.01	7.756 ± 0.157	3.150 ± 0.079	1.575 ± 0.118	10.906 ± 0.394	2.126 ± 0.118

Safety Factor 4:1

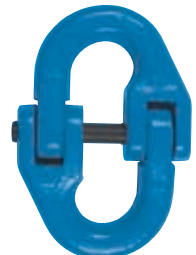
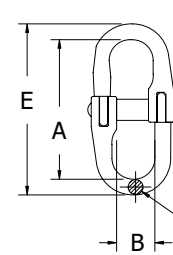

Stamped with BM identification code, size, grade and traceability code. Meet ASTM-952 standard.

Eye Cradle Grab Hooks (Gr. 100, alloy steel, quenched and tempered)

Code	Marking	For Chain Size in.	Working Load Limit lbs.	Weight / each lbs.	Dimensions in.							
					C	D	E	F	G	H	T	
EGH100-732BM	6-10	7/32	3,100	0.33	1.831 ± 0.079	0.315 ± 0.020	1.811 ± 0.118	2.874 ± 0.118	0.531 ± 0.039	0.315 ± 0.039	1.004 ± 0.059	
EGH100-932BM	8-10	9/32 - 5/16	5,700	0.66	2.087 ± 0.079	0.374 ± 0.020	2.402 ± 0.118	3.661 ± 0.118	0.689 ± 0.039	0.433 ± 0.039	1.319 ± 0.059	
EGH100-038BM	10-10	3/8	8,800	1.74	2.913 ± 0.079	0.551 ± 0.020	3.346 ± 0.118	5.079 ± 0.118	0.866 ± 0.059	0.531 ± 0.059	1.654 ± 0.079	
EGH100-012BM	13-10	1/2	15,000	3.67	3.780 ± 0.118	0.728 ± 0.039	4.094 ± 0.157	6.535 ± 0.157	1.063 ± 0.059	0.669 ± 0.059	2.106 ± 0.079	
EGH100-058BM	16-10	5/8	22,600	6.03	4.567 ± 0.118	0.866 ± 0.039	4.685 ± 0.157	7.323 ± 0.157	1.417 ± 0.079	0.748 ± 0.059	2.913 ± 0.098	
EGH100-034BM	20-10	3/4	35,300	10.38	5.709 ± 0.118	0.906 ± 0.059	5.748 ± 0.197	8.858 ± 0.197	1.732 ± 0.079	0.984 ± 0.079	3.425 ± 0.098	
EGH100-078BM	22-10	7/8	42,700	18.04	6.319 ± 0.118	1.024 ± 0.059	6.516 ± 0.197	10.256 ± 0.197	1.909 ± 0.079	1.063 ± 0.079	3.543 ± 0.118	
EGH100-001BM	26-10	1	59,700	24.97	7.480 ± 0.118	1.339 ± 0.059	8.031 ± 0.197	12.244 ± 0.197	2.047 ± 0.079	1.339 ± 0.079	4.331 ± 0.118	
EGH100-114BM	32-10	1 1/4	90,400	45.43	9.016 ± 0.157	1.575 ± 0.079	9.685 ± 0.197	14.685 ± 0.197	2.520 ± 0.079	1.614 ± 0.079	5.118 ± 0.118	

Safety Factor 4:1

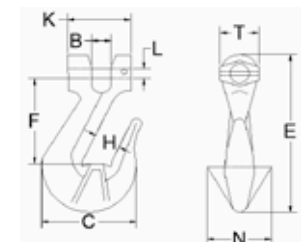

Stamped with BM identification code, size, grade and traceability code. Meet ASTM-952 standard.

Grade 80

Proof Tested & Certified Chain Slings – Grade 80

Chain Diameter in.	Working Load Limit (lbs.)					
	Single Leg 90°	Double Legs 60°	Double Legs 45°	Double Legs 30°	SINGLE	DOUBLE
7/32	2,100	3,600	2,900	2,100	A342-012BM	A342-012BM
9/32	3,500	6,100	4,900	3,500	A342-012BM	A342-058BM
5/16	4,500	7,700	6,300	4,500	A342-012BM	A342-058BM
3/8	7,100	12,300	10,000	7,100	A342-034BM	A342-034BM
1/2	12,000	20,800	17,000	12,000	A342-001BM	A342-001BM
5/8	18,100	31,300	25,600	18,100	A342-001BM	A342-114BM
3/4	28,300	49,000	40,000	28,300	A342-114BM	A342-112BM
7/8	34,200	59,200	48,400	34,200	A342-112BM	A342-134BM
1	47,700	82,600	67,400	47,700	A342-134BM	A342-002BM
1 1/4	72,300	125,200	102,000	72,300	A342-002BM	A342-214BM

Safety Factor 4:1

*See dimensions on page 67

Chain Diameter in.	Working Load Limit (lbs.)			
	Three/Four Legs 60°	Three/Four Legs 45°	Three/Four Legs 30°	
7/32	5,400	4,400	3,100	SUB-012
9/32	9,100	7,400	5,200	SUB-034
5/16	11,600	9,500	6,700	SUB-001
3/8	18,400	15,100	10,600	SUB-001
1/2	31,200	25,500	18,000	SUB-114
5/8	47,000	38,400	27,100	SUB-112
3/4	73,500	60,000	42,400	SUB-134
7/8	88,900	72,500	51,300	SUB-002
1	123,900	101,200	71,500	SUB-212
1 1/4	187,800	153,400	108,400	SUB-234

Safety Factor 4:1

*See dimensions on page 67

Alloy Lifting Chain (Gr. 80 - black cataphoresis)

Grade 80 alloy chain is used for overhead lifting.

Code	Diameter in.	Working Weight		Dimensions in.			
		Load Limit lbs.	100 ft. lbs.	A	B Min	C Max	D
CH80SC-732	7/32	2,100	47.0	.590	.375	.787	.220
CH80SC-932	9/32	3,500	73.8	.826	.394	.992	.276
CH80SC-516	5/16	4,500	93.9	.945	.453	1.134	.315
CH80SC-038	3/8	7,100	147.5	1.181	.571	1.417	.394
CH80SC-012	1/2	12,000	254.8	1.535	.748	1.843	.512
CH80SC-058	5/8	18,100	383.0	1.890	.925	2.268	.630
CH80SC-034	3/4	28,300	578.0	2.362	1.102	2.776	.787
CH80SC-078	7/8	34,200	732.4	2.598	1.161	3.118	.866
CH80SC-001	1	47,700	1,021.4	3.071	1.457	3.685	1.024
CH80SC-114	1 1/4	72,300	1,545.5	3.780	1.890	4.528	1.260

Safety Factor 4:1

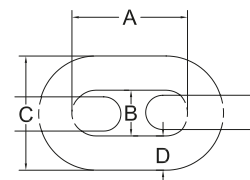

Meet NACM and ASTM 391 standards.

WARNING: The maximum loads shown are applicable only for new products or in perfect condition.

WARNING: Do not exceed maximum rated capacities.



Master Oblong Links (Gr. 80 - alloy steel, quenched and tempered)

Code	Working Load Limit lbs.	Weight / ea. lbs.	Dimensions in.					
			A		B		D	
			Min	Max	Min	Max	Min	Max
A342-012BM	7,400	0.79	4.764	5.236	2.303	2.697	0.472	0.551
A342-058BM	8,800	1.54	5.748	6.220	2.795	3.189	0.591	0.669
A342-034BM	12,300	2.05	5.276	5.748	2.559	2.953	0.709	0.787
A342-001BM	26,000	3.30	6.772	7.244	3.307	3.701	0.945	1.024
A342-114BM	39,000	4.62	8.465	9.016	4.134	4.606	1.181	1.339
A342-112BM	61,000	9.33	10.236	10.787	5.079	5.551	1.417	1.575
A342-134BM	84,800	15.77	11.614	12.402	5.748	6.220	1.693	1.850
A342-002BM	102,500	25.41	13.583	14.370	6.772	7.244	1.929	2.087
A342-214BM	143,000	37.84	15.591	16.378	7.717	8.268	2.165	2.323
A342-212BM	160,000	53.90	15.591	16.378	7.717	8.268	2.382	2.618
A342-234BM	216,900	67.98	15.591	16.378	9.213	9.764	2.638	2.874

Safety Factor 5:1

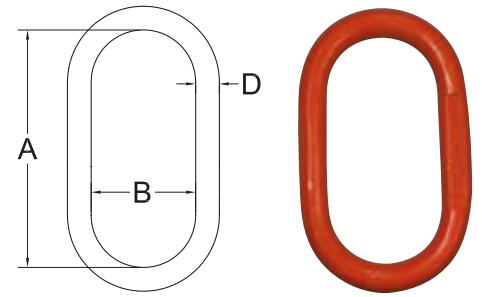

Stamped with BM identification code, size, grade and traceability code. Meet ASTM standard.

Welded Master Link Assemblies (Gr. 80 - alloy steel, quenched and tempered)

Code	Working Load Limit lbs.	Weight / ea. lbs.	Dimensions in.											
			A1		B1		D1		A2		B2		D2	
			Min	Max	Min	Max	Min	Max	Min	Max	Min	Max	Min	Max
SUB-012	7,400	1.80	3.740	4.134	2.165	2.559	0.512	0.591	3.150	3.543	1.457	1.693	0.433	0.512
SUB-034	12,300	3.41	5.276	5.748	2.559	2.953	0.748	0.827	3.150	3.543	1.457	1.693	0.512	0.591
SUB-001	26,000	4.80	6.772	7.244	3.307	3.701	0.945	1.024	3.740	4.134	2.165	2.559	0.669	0.748
SUB-114	39,000	15.80	8.465	9.016	4.094	4.567	1.181	1.339	3.740	4.134	2.165	2.559	0.827	0.906
SUB-112	61,000	28.40	10.236	10.787	5.079	5.551	1.417	1.575	6.850	7.323	3.740	4.134	1.102	1.260
SUB-134	84,800	46.75	11.614	12.402	5.748	6.220	1.693	1.850	6.850	7.323	3.740	4.134	1.181	1.339
SUB-002	102,500	66.75	13.622	14.409	6.772	7.244	1.890	2.047	6.850	7.323	3.740	4.134	1.417	1.575
SUB-212	160,000	141.68	15.591	16.378	7.756	8.228	2.441	2.598	13.661	14.291	6.772	7.244	1.929	2.087
SUB-234	216,900	195.80	15.591	16.378	8.189	8.661	2.677	2.835	15.669	16.299	7.756	8.228	2.165	2.323

Safety Factor 5:1

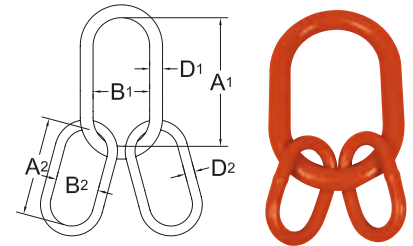

Stamped with BM identification code, size, grade and traceability code. Meet ASTM standard.

Safety Latch Kit (Gr. 80, for sling hooks)

Code	For Chain Size in.	Weight / ea. lbs.
LATCHGR807/32	7/32	0.07
LATCHGR809/32	9/32	0.09
LATCHGR803/8	3/8	0.14
LATCHGR801/2	1/2	0.30
LATCHGR805/8	5/8	0.33
LATCHGR803/4	3/4	0.51
LATCHGR807/8	7/8	0.72
LATCHGR801	1	0.90
LATCHGR8011/4	1 1/4	1.44



Weldless Master Rings (carbon steel, quenched and tempered)

Code	Working Load Limit lbs.	Weight / each lbs.	Dimensions in.	
			A	D
S643-078004BM	7,200	2.7	4	7/8
S643-078512BM	5,600	3.4	5 1/2	7/8
S643-001004BM	10,800	3.5	4	1
S643-118006BM	10,400	6.5	6	1 1/8
S643-114005BM	17,000	7.0	5	1 1/4
S643-138006BM	19,000	10.6	6	1 3/8

Safety Factor 6:1

Federal Specification : RR-C-2716-16

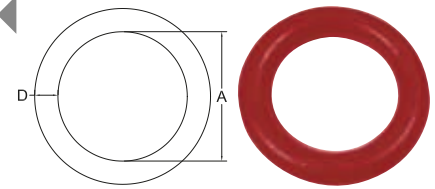

Stamped with BM identification code, size, grade and traceability code. Meet ASTM standard.

Pear Shape Weldless Links (Hot dip galvanized, alloy steel, quenched and tempered)

Code	Working Load Limit lbs.	Weight / each lbs.	Dimensions in.	
			A	D
A341-038BM	3,600	0.22	2 1/4	3/8
A341-012BM	7,000	0.55	3	1/2
A341-058BM	9,000	1.10	3 3/4	5/8
A341-034BM	12,300	1.76	4 1/2	3/4
A341-078BM	14,000	3.08	5 1/4	7/8
A341-001BM	24,360	4.18	6	1
A341-114BM	36,000	8.26	7 3/4	1 1/4
A341-138BM	43,000	11.28	8 1/4	1 3/8

Safety Factor 5:1

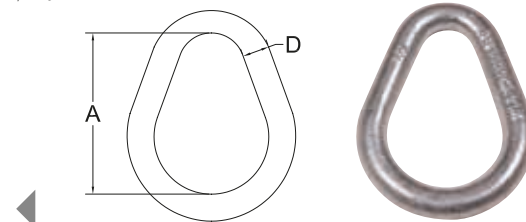

Stamped with BM identification code, size, grade and traceability code. Meet ASTM standard.

Clevis Sling Hooks with latch* (Gr. 80 - Alloy steel, quenched and tempered)

Code	Marking	For Chain Size in.	Working Load Limit lbs.	Weight / each lbs.	Dimensions in.										
					B	C	E	F	H	K	L	M	N		
CSH80L-732BM	6-8	7/32	2,100	0.73	0.315 ± 0.039	3.012 ± 0.079	4.331 ± 0.118	2.965 ± 0.079	0.925 ± 0.079	1.244 ± 0.079	0.299 ± 0.008	0.780 ± 0.039	0.551 ± 0.039		
CSH80L-932BM	7/8-8	9/32 - 5/16	4,500	1.21	0.374 ± 0.039	3.307 ± 0.079	5.039 ± 0.118	3.386 ± 0.079	0.866 ± 0.079	1.441 ± 0.079	0.354 ± 0.008	0.984 ± 0.039	0.709 ± 0.039		
CSH80L-038BM	10-8	3/8	7,100	2.11	0.492 ± 0.039	4.055 ± 0.079	6.220 ± 0.118	4.094 ± 0.118	1.181 ± 0.079	1.929 ± 0.079	0.500 ± 0.008	1.220 ± 0.039	0.906 ± 0.039		
CSH80L-012BM	13-8	1/2	12,000	3.34	0.650 ± 0.079	5.197 ± 0.118	7.807 ± 0.157	5.039 ± 0.118	1.476 ± 0.118	2.224 ± 0.118	0.630 ± 0.008	1.673 ± 0.079	1.083 ± 0.039		
CSH80L-058BM	16-8	5/8	18,100	7.55	0.846 ± 0.079	6.299 ± 0.118	9.213 ± 0.157	5.839 ± 0.157	1.831 ± 0.118	2.776 ± 0.118	0.776 ± 0.008	2.126 ± 0.079	1.378 ± 0.059		
CSH80L-034BM	20-8	3/4	28,300	14.81	0.945 ± 0.079	7.311 ± 0.118	10.787 ± 0.157	6.929 ± 0.157	2.165 ± 0.118	3.031 ± 0.118	0.945 ± 0.008	2.283 ± 0.079	1.654 ± 0.059		
CSH80L-078BM	22-8	7/8	34,200	25.30	0.984 ± 0.079	8.976 ± 0.157	12.598 ± 0.197	8.386 ± 0.197	2.598 ± 0.157	3.583 ± 0.157	1.024 ± 0.008	2.441 ± 0.079	1.969 ± 0.079		
CSH80L-001BM	26-8	1	47,700	33.65	1.181 ± 0.079	10.118 ± 0.157	15.315 ± 0.197	9.906 ± 0.197	3.346 ± 0.157	4.606 ± 0.157	1.299 ± 0.008	2.953 ± 0.118	2.362 ± 0.079		
CSH80L-114BM	32-8	1 1/4	72,300	56.85	1.378 ± 0.079	12.520 ± 0.197	18.898 ± 0.236	12.480 ± 0.236	4.055 ± 0.197	5.906 ± 0.197	1.602 ± 0.008	3.465 ± 0.118	2.598 ± 0.079		

Safety Factor 4:1

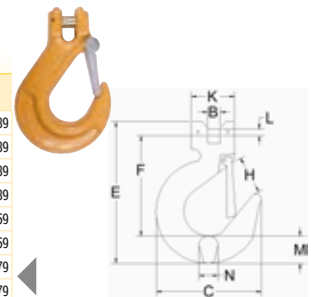

Stamped with BM identification code, size, grade and traceability code. Meet ASTM-952 standard.

* Replacement safety latch kit available. See on page 67.

BEN-MOR Hooked on Service

Eye Foundry Hooks (Gr. 80 - Alloy steel, quenched and tempered)

Code	Marking	For Chain Size in.	Working Load Limit lbs.	Weight / each lbs.	Dimensions in.										
					C	E	F	G	H	K	M	N	O		
EFH80-932	7/8-8	9/32 - 5/16	4,500	2.40	4.764 ± 0.079	6.417 ± 0.157	4.764 ± 0.079	0.709 ± 0.039	2.480 ± 0.079	1.575 ± 0.039	1.220 ± 0.039	1.000 ± 0.039	0.709 ± 0.039		
EFH80-038	10-8	3/8	7,100	4.49	5.748 ± 0.098	7.913 ± 0.157	5.787 ± 0.079	0.866 ± 0.039	2.992 ± 0.098	2.000 ± 0.059	1.496 ± 0.039	1.283 ± 0.039	0.906 ± 0.039		
EFH80-012	13-8	1/2	12,000	7.08	6.654 ± 0.098	9.429 ± 0.236	6.890 ± 0.118	1.063 ± 0.059	3.465 ± 0.098	2.500 ± 0.059	1.752 ± 0.059	1.496 ± 0.059	1.063 ± 0.059		
EFH80-058	16-8	5/8	18,100	12.17	7.795 ± 0.098	11.023 ± 0.236	8.110 ± 0.118	1.260 ± 0.059	4.016 ± 0.098	2.992 ± 0.059	2.047 ± 0.059	1.811 ± 0.059	1.260 ± 0.059		
EFH80-034	20-8	3/4	28,300	19.25	9.134 ± 0.118	12.823 ± 0.256	9.280 ± 0.118	1.496 ± 0.059	4.469 ± 0.098	3.504 ± 0.059	2.559 ± 0.079	2.205 ± 0.079	1.535 ± 0.059		
EFH80-078	22-8	7/8	34,200	26.25	10.079 ± 0.118	14.213 ± 0.276	10.354 ± 0.118	1.772 ± 0.079	5.020 ± 0.118	4.016 ± 0.079	2.717 ± 0.079	2.244 ± 0.079	1.575 ± 0.079		
EFH80-001	26-8	1	47,700	36.96	11.220 ± 0.118	15.827 ± 0.315	11.614 ± 0.157	2.618 ± 0.098	5.512 ± 0.118	4.961 ± 0.079	2.953 ± 0.079	2.598 ± 0.079	1.772 ± 0.079		
EFH80-114	32-8	1 1/4	72,300	58.52	12.756 ± 0.138	18.130 ± 0.315	12.913 ± 0.157	3.209 ± 0.098	5.965 ± 0.118	5.965 ± 0.079	3.839 ± 0.079	3.150 ± 0.079	2.283 ± 0.079		

Safety Factor 4:1

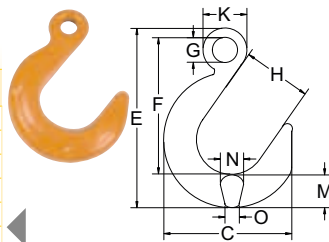

Stamped with BM identification code, size, grade and traceability code. Meet ASTM-952 standard.

Eye Self Locking Hooks* (Gr. 80 - Alloy steel, quenched and tempered)

Code	Marking	For Chain Size in.	Working Load Limit lbs.	Weight / each lbs.	Dimensions in.						
					C	D	F	G	H min	M	N
S316-732	6-8	7/32	2,100	1.10	2.835 ± 0.079	0.433 ± 0.039	4.331 ± 0.118	0.827 ± 0.039	1.102	0.787 ± 0.039	0.591 ± 0.039
S316-014	7/8-8	1/4 - 5/16	4,500	1.83	3.583 ± 0.079	0.512 ± 0.039	5.354 ± 0.118	0.984 ± 0.039	1.378	1.024 ± 0.039	0.787 ± 0.039
S316-038	10-8	3/8	7,100	3.12	4.252 ± 0.079	0.591 ± 0.039	6.614 ± 0.118	1.358 ± 0.059	1.772	1.181 ± 0.059	1.024 ± 0.039
S316-012	13-8	1/2	12,000	6.29	5.591 ± 0.118	0.827 ± 0.039	8.110 ± 0.157	1.555 ± 0.059	2.067	1.575 ± 0.059	1.299 ± 0.039
S316-058	16-8	5/8	18,100	12.98	6.638 ± 0.118	1.063 ± 0.039	10.000 ± 0.157	1.969 ± 0.079	2.480	1.988 ± 0.079	1.496 ± 0.079
S316-034	20-8	3/4	28,300	18.70	7.283 ± 0.157	1.063 ± 0.039	10.945 ± 0.197	2.539 ± 0.079	3.228	2.165 ± 0.079	1.969 ± 0.079
S316-078	22-8	7/8	34,200	25.52	7.953 ± 0.157	1.260 ± 0.059	12.559 ± 0.197	2.756 ± 0.118	2.992	2.638 ± 0.079	2.047 ± 0.079
S316-001	26-8	1	47,700	41.80	9.409 ± 0.197	1.339 ± 0.059	14.252 ± 0.236	3.150 ± 0.118	3.780	2.953 ± 0.118	2.362 ± 0.118
S316-114	32-8	1 1/4	72,300	101.20	12.953 ± 0.197	1.772 ± 0.059	18.504 ± 0.236	4.134 ± 0.157	5.157	3.819 ± 0.118	3.130 ± 0.118

Safety Factor 4:1

* Replacement latch kit trigger available. See on page 67.

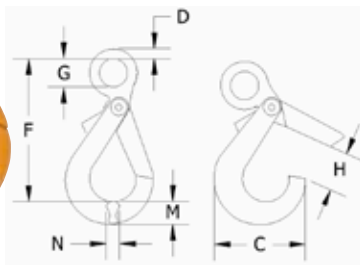

Stamped with BM identification code, size, grade and traceability code. Meet ASTM-952 standard.

Clevis Self Locking Hooks* (Gr. 80 - Alloy steel, quenched and tempered)

Code	Marking	For Chain Size in.	Working Load Limit lbs.	Weight / each lbs.	Dimensions in.							
					B	C	E	F	H min	K	L	N
S317-732	6-8	7/32	2,100	0.99	0.315 ± 0.020	2.874 ± 0.079	5.276 ± 0.118	3.898 ± 0.118	1.102	1.260 ± 0.039	0.299 ± 0.008	0.591 ± 0.039
S317-014	7/8-8	1/4 - 5/16	4,500	1.87	0.374 ± 0.020	3.583 ± 0.079	6.378 ± 0.118	4.685 ± 0.118	1.378	1.516 ± 0.059	0.354 ± 0.008	0.787 ± 0.039
S317-038	10-8	3/8	7,100	3.26	0.492 ± 0.197	4.252 ± 0.079	7.677 ± 0.118	5.591 ± 0.118	1.772	1.811 ± 0.059	0.512 ± 0.008	1.024 ± 0.039
S317-012	13-8	1/2	12,000	6.27	0.591 ± 0.020	5.591 ± 0.118	9.764 ± 0.157	7.047 ± 0.157	2.067	2.323 ± 0.059	0.630 ± 0.008	1.299 ± 0.039
S317-058	16-8	5/8	18,100	13.20	0.728 ± 0.020	6.638 ± 0.118	12.205 ± 0.157	8.858 ± 0.157	2.480	3.031 ± 0.059	0.787 ± 0.008	1.496 ± 0.079
S317-034	20-8	3/4	28,300	16.50	0.945 ± 0.039	7.283 ± 0.157	13.189 ± 0.197	9.370 ± 0.197	3.228	3.189 ± 0.059	0.945 ± 0.008	1.969 ± 0.079
S317-078	22-8	7/8	34,200	16.50	0.984 ± 0.039	7.953 ± 0.157	15.433 ± 0.197	10.906 ± 0.197	2.992	3.839 ± 0.079	1.102 ± 0.008	2.047 ± 0.079
S317-001	26-8	1	47,700	27.02	1.181 ± 0.059	9.409 ± 0.197	17.677 ± 0.236	12.283 ± 0.236	3.780	4.646 ± 0.079	1.299 ± 0.008	2.362 ± 0.118
S317-114	32-8	1 1/4	72,300	47.96	1.378 ± 0.059	12.953 ± 0.197	23.228 ± 0.236	16.378 ± 0.236	5.157	5.906 ± 0.079	1.602 ± 0.008	3.130 ± 0.118

Safety Factor 4:1

* Replacement latch kit trigger available. See on page 67.

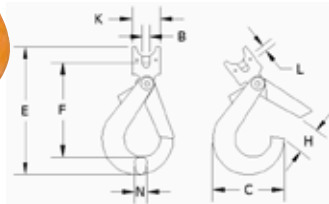

Stamped with BM identification code, size, grade and traceability code. Meet ASTM-952 standard.

Swivel Self Locking Hooks* (Gr. 80 - Alloy steel, quenched and tempered)

Code	Marking	For Chain Size in.	Working Load Limit lbs.	Weight / each lbs.	Dimensions in.							
					C	D	E	F	H min	I	J	N
S326-732	6-8	7/32	2,100	1.10	2.874 ± 0.079	0.472 ± 0.039	7.244 ± 0.118	5.984 ± 0.118	1.102	1.004 ± 0.079	1.280 ± 0.039	0.591 ± 0.020
S326-014	7/8-8	1/4 - 5/16	4,500	1.83	3.583 ± 0.079	0.512 ± 0.039	8.976 ± 0.118	7.441 ± 0.118	1.378	1.161 ± 0.079	1.417 ± 0.039	0.787 ± 0.039
S326-038	10-8	3/8	7,100	3.12	4.252 ± 0.079	0.591 ± 0.059	10.551 ± 0.118	8.780 ± 0.118	1.772	1.535 ± 0.079	1.654 ± 0.039	1.024 ± 0.039
S326-012	13-8	1/2	12,000	6.29	5.591 ± 0.118	0.630 ± 0.059	12.717 ± 0.157	10.512 ± 0.157	2.067	1.614 ± 0.079	1.969 ± 0.039	1.299 ± 0.059
S326-058	16-8	5/8	18,100	12.98	6.638 ± 0.118	0.846 ± 0.079	16.181 ± 0.157	13.346 ± 0.157	2.480	2.283 ± 0.098	2.756 ± 0.059	1.496 ± 0.079
S326-034	18-8	3/4	28,300	18.70	7.283 ± 0.157	1.063 ± 0.079	17.795 ± 0.197	14.567 ± 0.197	3.228	2.480 ± 0.098	2.835 ± 0.059	1.969 ± 0.079
S326-078	20-8	7/8	34,200	25.52	7.953 ± 0.157	1.220 ± 0.079	22.205 ± 0.197	18.346 ± 0.197	2.992	3.858 ± 0.118	3.819 ± 0.079	2.047 ± 0.079
S326-001	26-8	1	47,700	41.80	9.409 ± 0.197	1.654 ± 0.118	26.024 ± 0.236	21.417 ± 0.236	3.780	4.528 ± 0.118	4.843 ± 0.079	2.362 ± 0.118
S326-114	32-8	1 1/4	72,300	101.20	12.953 ± 0.197	2.126 ± 0.118	32.667 ± 0.236	26.732 ± 0.236	5.157	5.787 ± 0.118	5.512 ± 0.079	3.130 ± 0.118

Safety Factor 4:1

* Replacement latch kit trigger available. See on page 67.

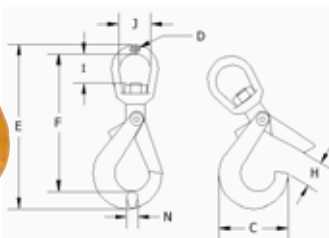

Stamped with BM identification code, size, grade and traceability code. Meet ASTM-952 standard.

Clevis Cradle Grab Hooks (Gr. 80, alloy steel, quenched and tempered)

Code	Marking	For Chain Size in.	Working Load Limit lbs.	Weight / each lbs.	Dimensions in.								
					B	C	E	F	H	K	L	N	T
CGH80-732BM	6-8	7/32	2,100	0.55	0.295 ± 0.020	1.772 ± 0.079	3.031 ± 0.079	1.772 ± 0.079	0.315 ± 0.020	1.260 ± 0.039	0.299 ± 0.008	0.846 ± 0.039	0.709 ± 0.039
CGH80-932BM	7/8-8	9/32 - 5/16	4,500	0.70	0.374 ± 0.020	2.087 ± 0.079	3.304 ± 0.079	2.087 ± 0.079	0.413 ± 0.020	1.535 ± 0.039	0.354 ± 0.008	1.358 ± 0.039	0.945 ± 0.059
CGH80-038BM	10-8	3/8	7,100	1.61	0.492 ± 0.020	2.795 ± 0.118	4.961 ± 0.118	2.953 ± 0.118	0.512 ± 0.020	1.831 ± 0.079	0.492 ± 0.008	1.811 ± 0.039	1.161 ± 0.059
CGH80-012BM	13-8	1/2	12,000	3.52	0.591 ± 0.039	3.780 ± 0.118	6.437 ± 0.118	3.622 ± 0.118	0.650 ± 0.039	2.087 ± 0.079	0.630 ± 0.008	2.264 ± 0.079	1.457 ± 0.059
CGH80-058BM	16-8	5/8	18,100	6.16	0.728 ± 0.039	4.449 ± 0.118	7.224 ± 0.118	3.898 ± 0.118	0.748 ± 0.039	2.736 ± 0.079	0.776 ± 0.008	2.913 ± 0.079	1.811 ± 0.079
CGH80-034BM	20-8	3/4	28,300	11.00	0.906 ± 0.039	5.630 ± 0.118	8.622 ± 0.118	4.843 ± 0.118	0.945 ± 0.059	3.189 ± 0.118	0.945 ± 0.008	2.913 ± 0.079	2.047 ± 0.079
CGH80-078BM	22-8	7/8	34,200	13.86	1.063 ± 0.039	6.299 ± 0.157	10.000 ± 0.157	5.512 ± 0.157	1.063 ± 0.059	3.583 ± 0.118	1.024 ± 0.008	3.543 ± 0.079	2.402 ± 0.098
CGH80-001BM	26-8	1	47,700	31.90	1.181 ± 0.039	7.126 ± 0.157	12.165 ± 0.157	7.362 ± 0.157	1.181 ± 0.059	4.606 ± 0.118	1.299 ± 0.008	4.016 ± 0.079	2.756 ± 0.098
CGH80-114BM	32-8	1 1/4	72,300	53.46	1.378 ± 0.059	9.016 ± 0.157	14.882 ± 0.157	8.386 ± 0.157	1.614 ± 0.079	5.906 ± 0.118	1.602 ± 0.008	5.118 ± 0.079	3.150 ± 0.098

Safety Factor 4:1

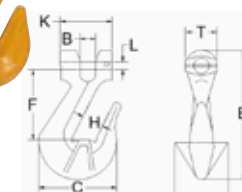

Stamped with BM identification code, size, grade and traceability code. Meet ASTM-952 standard.



Eye Sling Hooks with latch* (Gr. 80, alloy steel, quenched and tempered)

Code	Marking	For Chain Size in.	Working Load Limit lbs.	Weight / each lbs.	Dimensions in.						
					C	D	E	F	G	T	
ESH80L-732BM	6-8	7/32	2,100	0.55	3.310 ± 0.157	0.354 ± 0.039	4.252 ± 0.157	3.150 ± 0.118	0.787 ± 0.039	0.807 ± 0.079	0.531 ± 0.039
ESH80L-932BM	7/8-8	9/32 - 5/16	4,500	0.88	3.500 ± 0.157	0.433 ± 0.039	5.236 ± 0.157	3.878 ± 0.118	0.984 ± 0.039	1.024 ± 0.079	0.709 ± 0.039
ESH80L-038BM	10-8	3/8	7,100	1.98	4.340 ± 0.157	0.591 ± 0.039	6.594 ± 0.197	4.724 ± 0.157	1.496 ± 0.079	1.024 ± 0.079	0.866 ± 0.039
ESH80L-012BM	13-8	1/2	12,000	4.27	5.500 ± 0.157	0.748 ± 0.059	8.406 ± 0.197	5.984 ± 0.157	1.693 ± 0.079	1.457 ± 0.118	1.063 ± 0.039
ESH80L-058BM	16-8	5/8	18,100	6.36	6.340 ± 0.157	0.906 ± 0.059	10.039 ± 0.236	7.303 ± 0.157	1.969 ± 0.079	1.575 ± 0.118	1.339 ± 0.079
ESH80L-034BM	20-8	3/4	28,300	12.76	7.830 ± 0.157	0.945 ± 0.059	11.969 ± 0.236	8.622 ± 0.197	2.480 ± 0.118	1.693 ± 0.118	1.654 ± 0.079
ESH80L-078BM	22-8	7/8	34,200	20.24	8.590 ± 0.157	1.260 ± 0.079	13.720 ± 0.236	9.488 ± 0.197	2.441 ± 0.118	2.677 ± 0.157	1.732 ± 0.079
ESH80L-001BM	26-8	1	47,700	28.82	9.590 ± 0.157	1.378 ± 0.079	15.551 ± 0.276	10.984 ± 0.197	2.520 ± 0.118	3.228 ± 0.197	2.362 ± 0.118
ESH80L-114BM	32-8	1 1/4	72,300	44.198	11.560 ± 0.157	1.457 ± 0.079	18.898 ± 0.315	13.976 ± 0.236	3.465 ± 0.118	3.937 ± 0.197	2.598 ± 0.118

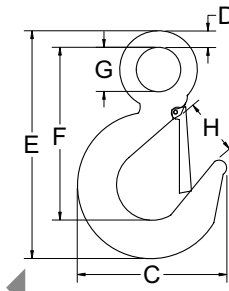

Stamped with BM identification code, size, grade and traceability code. Meet ASTM-952 standard.

* Replacement safety latch kit available. See on page 67. Latch kit available.

Safety Factor 4:1

Hammerlock Type Connecting Links (Gr. 80, alloy steel, quenched and tempered)

Code	Marking	For Chain Size in.	Working Load Limit lbs.	Weight / each lbs.	Dimensions in.				
					A	B	D	E	T
A337-732BM	6-8	7/32	2,100	0.18	1.535 ± 0.079	0.610 ± 0.039	0.295 ± 0.020	2.126 ± 0.098	0.433 ± 0.039
A337-932516BM	7/8-8	9/32 - 5/16	4,500	0.32	2.362 ± 0.079	0.807 ± 0.039	0.354 ± 0.020	3.071 ± 0.098	0.512 ± 0.039
A337-038BM	10-8	3/8	7,100	0.70	2.874 ± 0.079	1.024 ± 0.039	0.472 ± 0.020	3.819 ± 0.098	0.701 ± 0.039
A337-012BM	13-8	1/2	12,000	1.52	3.346 ± 0.098	1.181 ± 0.059	0.591 ± 0.020	4.528 ± 0.118	0.906 ± 0.039
A337-058BM	16-8	5/8	18,100	2.64	4.213 ± 0.098	1.417 ± 0.059	0.772 ± 0.020	5.748 ± 0.118	1.102 ± 0.059
A337-034BM	18-8	3/4	28,300	4.33	4.646 ± 0.118	1.646 ± 0.059	0.945 ± 0.039	6.535 ± 0.118	1.339 ± 0.059
A337-078BM	20-8	7/8	34,200	6.75	5.512 ± 0.118	1.949 ± 0.059	1.055 ± 0.039	7.559 ± 0.157	1.575 ± 0.059
A337-001BM	26-8	1	47,700	10.30	6.339 ± 0.118	2.283 ± 0.079	1.220 ± 0.039	8.661 ± 0.157	1.654 ± 0.059
A337-114BM	32-8	1 1/4	72,300	19.25	7.913 ± 0.157	2.657 ± 0.079	1.496 ± 0.039	11.063 ± 0.157	2.008 ± 0.079

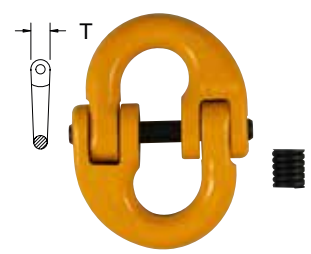
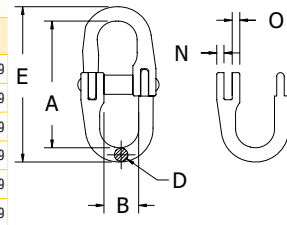

Stamped with BM identification code, size, grade and traceability code. Meet ASTM-952 standard.

Safety Factor 4:1

Eye Cradle Grab Hooks (Gr. 80, alloy steel, quenched and tempered)

Code	Marking	For Chain Size in.	Working Load Limit lbs.	Weight / each lbs.	Dimensions in.						
					C	D	E	F	G	T	
EGH80-732BM	6-8	7/32	2,100	0.31	1.791 ± 0.039	0.315 ± 0.020	2.874 ± 0.079	1.850 ± 0.059	0.571 ± 0.039	0.315 ± 0.020	0.846 ± 0.039
EGH80-932BM	7/8-8	9/32 - 5/16	4,500	0.68	2.087 ± 0.039	0.374 ± 0.020	3.661 ± 0.079	2.421 ± 0.059	0.689 ± 0.039	0.433 ± 0.020	1.201 ± 0.039
EGH80-038BM	10-8	3/8	7,100	1.43	2.795 ± 0.039	0.512 ± 0.020	4.803 ± 0.118	3.150 ± 0.059	0.807 ± 0.039	0.512 ± 0.020	1.811 ± 0.039
EGH80-012BM	13-8	1/2	12,000	3.06	3.780 ± 0.039	0.610 ± 0.039	6.220 ± 0.118	3.925 ± 0.079	1.024 ± 0.039	0.650 ± 0.039	2.264 ± 0.079
EGH80-058BM	16-8	5/8	18,100	4.84	4.449 ± 0.079	0.748 ± 0.039	6.654 ± 0.118	4.193 ± 0.079	1.201 ± 0.059	0.748 ± 0.039	2.835 ± 0.079
EGH80-034BM	20-8	3/4	28,300	10.12	5.630 ± 0.079	0.906 ± 0.059	8.622 ± 0.118	5.512 ± 0.079	1.476 ± 0.059	0.945 ± 0.059	2.913 ± 0.079
EGH80-078BM	22-8	7/8	34,200	18.04	6.299 ± 0.079	1.024 ± 0.059	10.197 ± 0.157	6.496 ± 0.079	1.732 ± 0.079	1.102 ± 0.059	3.543 ± 0.079
EGH80-001BM	26-8	1	47,700	21.56	7.126 ± 0.079	1.339 ± 0.079	12.047 ± 0.157	7.756 ± 0.079	1.929 ± 0.079	1.181 ± 0.059	4.331 ± 0.079
EGH80-114BM	32-8	1 1/4	72,300	42.68	9.016 ± 0.098	1.575 ± 0.079	14.685 ± 0.157	9.685 ± 0.098	2.520 ± 0.079	1.614 ± 0.059	5.118 ± 0.118

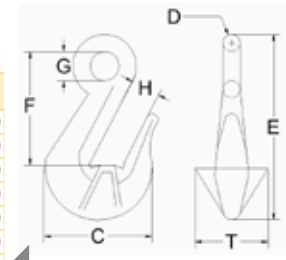

Stamped with BM identification code, size, grade and traceability code. Meet ASTM-952 standard.

Safety Factor 4:1

Choker Sliding Hooks (Gr. 80, alloy steel, quenched and tempered)

Code	Pour chaîne diamètre po	Charge maximale lb	Poids / ch. lb	Dimensions po				
				C ± 0.059	E ± 0.118	G ± 0.020	H ± 0.079	K ± 0.059
A350L-038012BM	3/8 - 1/2	3,300	1.50	2.80	5.20	0.67	0.71	1.97
A350L-058BM	5/8	4,400	2.66	3.11	5.94	0.87	0.75	2.50
A350L-034BM	3/4	6,600	4.38	4.06	6.69	1.10	1.02	2.72
A350L-001BM	1	11,000	9.20	5.31	8.35	1.28	1.30	3.37

Facteur de sécurité 5:1

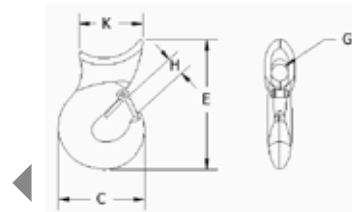

Eye Container Hooks (Gr. 80)

Code	Description	Charge maximale lb	Poids / ch. lb	Dimensions po							
				C ± 0.078 - 0.118	D ± 0.078 - 0.039	E ± 0.039 - 0.157	F ± 0.039	G ± 0.039 - 0.078	H ± 0.039	M ± 0.039	T ± 0.078
ECH	Straight	27,500	8.6	6.430	0.984	10.433	7.560	2.756	1.811	1.889	2.953
ECH-LEFT	Left 45 °	27,500	8.6	6.430	0.984	10.433	7.560	2.756	1.811	1.889	2.953
ECH-RIGHT	Right 45 °	27,500	8.6	6.430	0.984	10.433	7.560	2.756	1.811	1.889	2.953

Facteur de sécurité 4:1

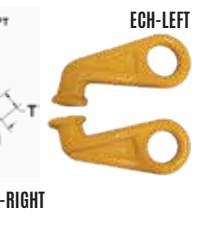
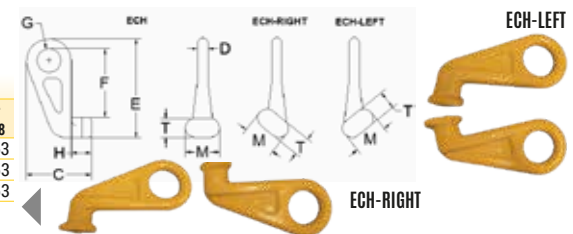

Weld-On Hooks

Code	Charge maximale lb	Poids / ch. lb	Dimensions po						
			C ± 0.098	E ± 0.98	F ± 0.078	H ± 0.098	M ± 0.078	N ± 0.078	T ± 0.078
WOH-003	6,600	3.1	4.173	5.079	2.953	1.181	1.181	0.945	1.417
WOH-005	11,000	6.6	5.236	6.693	3.937	1.535	1.693	1.102	1.712
WOH-008	17,600	8.4	5.394	6.969	3.898	1.417	1.968	1.535	2.008
WOH-010	22,000	13.9	6.653	8.819	5.512	1.929	2.165	1.496	2.087

Facteur de sécurité 4:1

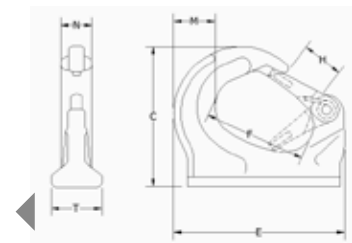

TAGLINE FOR LIFTING

The solution for safely directing and stabilizing a load from a distance.

The tagline allows an operator to control the swinging and rotation of a suspended load. Multiple taglines may be required to achieve optimal control over a load at height.

Double Braided Polyester Tagline Rope



Braided rope end for increased strength and better longevity.

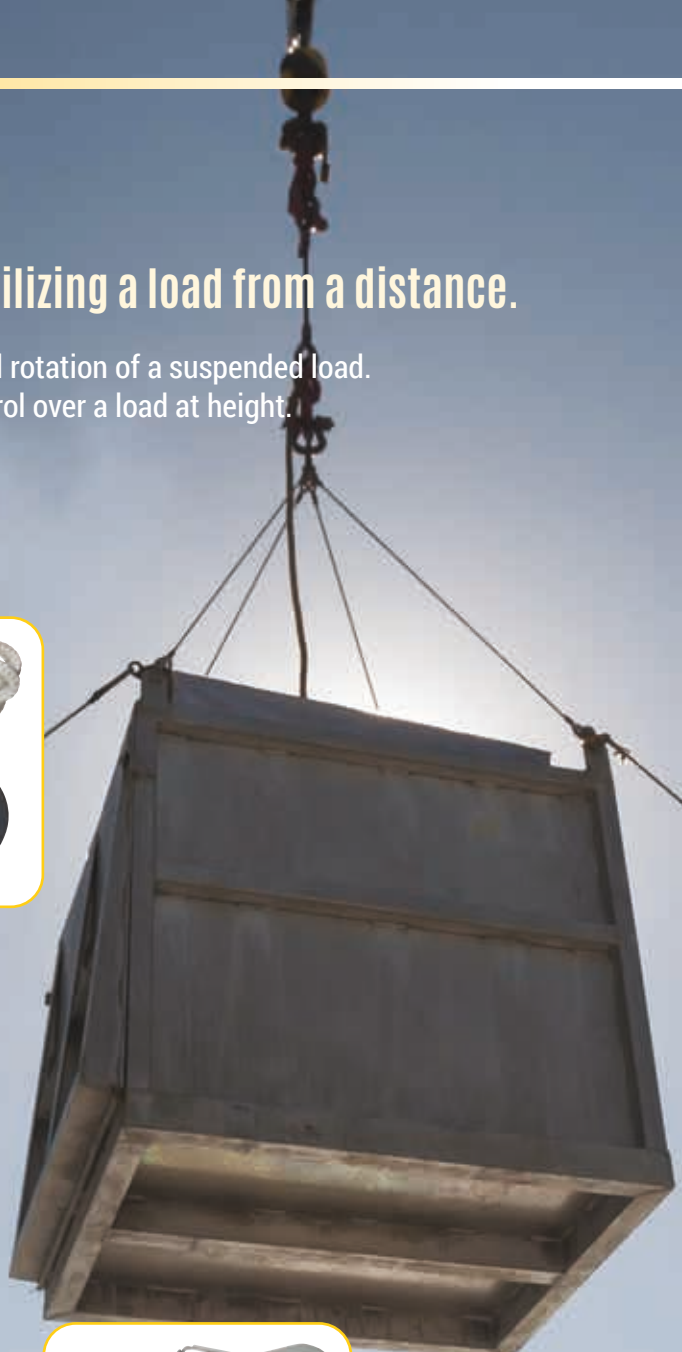

Double braided polyester rope with rebar hook

Code	Size		Length		Color	Pack/CTN	
	mm	in.	m	ft.			
TLREBDB012-015	12.7	1/2	4.6	15	Blanc	1	N-318
TLREBDB012-025	12.7	1/2	7.6	25	Blanc	1	N-318
TLREBDB012-050	12.7	1/2	15.2	50	Blanc	1	N-318
TLREBDB012-075	12.7	1/2	22.9	75	Blanc	1	N-318

Not intended for overhead lifting



Double braided polyester rope with eye hook with latch

Code	Size		Length		Color	Pack/CTN	
	mm	in.	m	ft.			
TLEHDB012-015	12.7	1/2	4.6	15	Blanc	1	EH-112
TLEHDB012-025	12.7	1/2	7.6	25	Blanc	1	EH-112
TLEHDB012-050	12.7	1/2	15.2	50	Blanc	1	EH-112
TLEHDB012-075	12.7	1/2	22.9	75	Blanc	1	EH-112

Not intended for overhead lifting



Other constructions and lengths available upon request. Please ask your account manager for more information.



WARNING : Do not use this rope to lift an object or a person. Do not use this rope to support a load at height. Do not wrap or tie the rope around yourself or any stationary object.
IMPORTANT : The rope must be long enough for the operator to maintain adequate control of the load while maintaining a safe distance at all times.



Tagline, nylon, twisted



Twisted nylon rope with rebar hook

Code	Size		Length		Color	Pack/CTN	
	mm	in.	m	ft.			
TLREBTWB012-015	12.7	1/2	4.6	15	Blanc	1	N-318
TLREBTWB012-025	12.7	1/2	7.6	25	Blanc	1	N-318
TLREBTWB012-050	12.7	1/2	15.2	50	Blanc	1	N-318
TLREBTWB012-075	12.7	1/2	22.9	75	Blanc	1	N-318

Not intended for overhead lifting



Twisted nylon rope with eye hook with latch

Code	Size		Length		Color	Pack/CTN	
	mm	in.	m	ft.			
TLEHTW012-015	12.7	1/2	4.6	15	Blanc	1	EH-112
TLEHTW012-025	12.7	1/2	7.6	25	Blanc	1	EH-112
TLEHTW012-050	12.7	1/2	15.2	50	Blanc	1	EH-112
TLEHTW012-075	12.7	1/2	22.9	75	Blanc	1	EH-112

Not intended for overhead lifting



Other constructions and lengths available upon request.
Please ask your account manager for more information.



WARNING : Do not use this rope to lift an object or a person. Do not use this rope to support a load at height.
Do not wrap or tie the rope around yourself or any stationary object.

IMPORTANT : The rope must be long enough for the operator to maintain adequate control of the load while maintaining a safe distance at all times.

Oblong Master Links

Code	Dim.	For Grade 80 Chain (in.)		Working Load Limit		Dimensions (in.)				Net Weight
		in.	1-Leg	2-Legs	lbs*	TONS*	D	IL	IW	lbs
8-003-06	w 3/8	7/32	--	--	3,000	1.25	0.43	3.94	2.36	0.4
8-003-0806	w 1/2	1/4-5/16	7/32	--	4,920	2.5	0.55	4.72	2.76	0.9
8-003-1008	w 5/8	3/8	1/4-5/16	--	6,600	4.0	0.67	5.51	3.15	1.5
8-003-13	w 3/4	1/2	--	--	10,320	5.4	0.75	5.91	3.54	2.4
8-003-1310	w 7/8	1/2	3/8	--	14,040	7.5	0.87	6.30	3.74	3.3
8-003-16	w 1	5/8	--	--	24,360	10.0	0.98	7.48	4.33	4.9
8-003-1613	w 1-1/8	5/8	1/2	--	27,000	10.0	1.10	7.09	4.13	6.2
8-003-19	w 1-1/4	3/4	--	--	35,160	12.0	1.18	7.87	4.72	8.4
8-003-2216	w 1-3/8	7/8	5/8	--	42,000	17.0	1.34	9.45	5.51	12.1
8-003-26	w 1-1/2	1	--	--	47,880	25.0	1.50	9.84	5.91	15.4
8-003-2619	w 1-5/8	1	3/4	--	60,600	28.0	1.57	9.84	5.91	17.6
8-003-3222	w 1-3/4	1-1/4	7/8	--	62,520	37.0	1.77	11.81	7.09	28.0

Forged Oblong Master Links.

* Design factor 4:1 proof tested and certified Tested acc. to EN 1677

Extra width inside allows better works on large crane hooks.

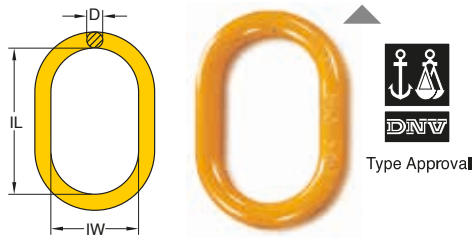

Coupling Pins & Sleeve Set

Code	Dimension		Working Load Limit
	in.	mm	TONS*
8-P015-06	7/32	6	1.12
8-P015-07	1/4 - 5/16	7	2.0
8-P015-10	3/8	10	3.15
8-P015-13	1/2	13	5.3
8-P015-16	5/8	16	8.0
8-P015-20	3/4	18, 20	12.5
8-P015-22	7/8	22	15.0
8-P015-26	1	26	21.2
8-P015-32	1 1/4	32	31.5



Load Pin Kits

8-026, 8-018, 8-022, 8-042, 8-043, 8-059, 8-060, 8-061, 8-064, 8-066, 8-068, 8-069, 8-075, 8-091, 8-097

H8-P026-20 could not be used with 8-042-20 and 8-060-20



Code	Dimension		Working Load Limit
	in.	mm	TONS*
8-P026-06	7/32	6	1.12
8-P026-07	1/4 - 5/16	7	2.0
8-P026-10	3/8	10	3.15
8-P026-13	1/2	13	5.3
8-P026-16	5/8	16	8.0
8-P026-20	3/4	18, 20	12.5
8-P026-22	7/8	22	15.0

Eye Sling Hooks with Latch

Code	Working Load Limit		For chain G80	Dimensions in.							Net Weight lbs
	lbs*	TONS*		in.	A	D	H	K	P1	T	
8-044/S-06	2,500	1.12	7/32	0.79	0.35	0.79	3.15	0.94	0.63	0.7	
8-044/S-07	4,500	2.0	1/4-5/16	0.98	0.43	0.91	3.86	1.18	0.75	1.1	
8-044/S-10	7,100	3.15	3/8	1.26	0.59	1.22	4.76	1.42	0.91	2.0	
8-044/S-13	12,000	5.3	1/2	1.57	0.71	1.50	5.98	1.69	1.10	4.2	
8-044/S-16	18,100	8.0	5/8	1.97	0.87	1.85	7.20	1.85	1.29	7.1	
8-044/S-20	28,300	12.5	3/4	2.36	1.06	1.89	8.54	1.77	1.69	12.6	
8-044/S-22	34,200	15.0	7/8	2.01	1.26	2.44	9.45	2.75	1.97	20.1	
8-044/S-26	47,700	21.2	1	2.60	1.34	3.15	10.63	3.15	2.36	30.0	
8-044/S-32	72,300	31.5	1-1/4	3.50	1.57	3.39	13.86	4.49	2.56	41.2	

* Design factor 4:1 proof tested and certified Tested acc. to EN 1677



ABS
Type Approval

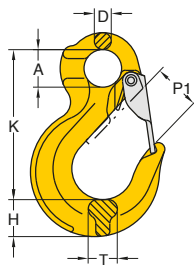

Trigger Kits for G80 and G100 Self Locking Hooks

Code	Dimension	
	in.	mm
8-P025-06	7/32	6
8-P025-07	1/4-5/16	7
8-P025-10	3/8	10
8-P025-13	1/2	13
8-P025-16	5/8	16
8-P025-20	3/4	18, 20
8-P025-22	7/8	22
8-P025-26	1	26
8-P025-28	1-1/8	28

**For G100 size 20mm: X-P025-20



Latch Kits for 8-081

Code	Dimension
	TONS*
8-P081-01	1
8-P081-02	2
8-P081-03	3
8-P081-04	4
8-P081-05	5
8-P081-08	8
8-P081-10	10
8-P081-15	15



Eye Self Locking Hooks

Code	Working Load Limit		For chain G80	Dimensions in.							Net Weight lbs
	lbs*	TONS*		in.	A	D	H	K	P	T	
8-025-06	2,500	1.12	7/32	0.83	0.39	0.75	4.33	1.14	0.59	1.1	
8-025-07	4,500	2.0	1/4-5/16	0.98	0.44	0.94	5.35	1.34	0.79	1.8	
8-025-10	7,100	3.15	3/8	1.26	0.51	1.19	6.57	1.77	1.02	3.1	
8-025-13	12,000	5.3	1/2	1.56	0.62	1.57	8.15	2.13	1.19	6.4	
8-025-16	18,100	8.0	5/8	2.05	0.83	1.93	9.92	2.44	1.42	12.6	
8-025-20	28,300	12.5	3/4	2.52	0.91	2.36	11.10	3.54	1.91	18.7	
8-025-22	34,200	15.0	7/8	2.75	0.94	2.48	12.56	3.14	2.12	27.6	
8-025-26	47,700	21.2	1	3.15	0.98	2.72	13.50	3.90	2.20	32.0	
8-025-28	55,100	24.8	1-1/8	3.54	1.10	3.18	15.80	4.72	2.48	54.9	

* Design factor 4:1 proof tested and certified Tested acc. to EN 1677

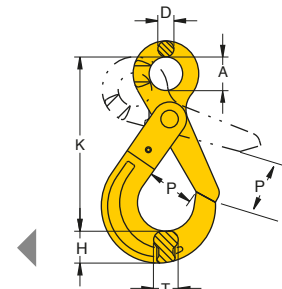

ABS
Type Approval

Clevis Self Locking Hooks

Code	Working Load Limit		For chain G80	Dimensions in.						Net Weight lbs
	lbs*	TONS*		in.	A	H	K	P	T	
8-026-06	2,500	1.12	7/32	0.24	0.75	3.94	1.14	0.59	1.1	
8-026-07	4,500	2.0	1/4-5/16	0.35	0.94	4.69	1.34	0.79	1.8	
8-026-10	7,100	3.15	3/8	0.43	1.19	5.63	1.77	1.02	3.1	
8-026-13	12,000	5.3	1/2	0.55	1.57	7.05	2.13	1.19	6.4	
8-026-16	18,100	8.0	5/8	0.71	1.93	8.35	2.44	1.42	12.4	
8-026-20	28,300	12.5	3/4	0.83	2.36	9.56	3.54	1.91	19.4	
8-026-22	34,200	15.0	7/8	0.95	2.48	10.70	3.14	2.12	28.2	

* Design factor 4:1 proof tested and certified
Tested acc. to EN 1677

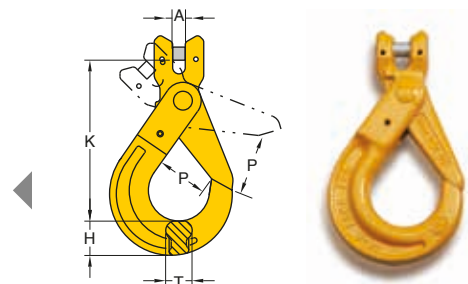

Swivel Self Locking Hooks with Brass Bushing

Code	Working Load Limit		For chain G80	Dimensions in.								Net Weight lbs
	lbs*	TONS*		in.	A	B	D	H	K	P	T	
8-027-06	2,500	1.12	7/32	1.26	0.87	0.44	0.75	5.86	1.14	0.59	1.5	
8-027-07	4,500	2.0	1/4-5/16	1.42	1.14	0.51	0.94	7.32	1.34	0.79	2.6	
8-027-10	7,100	3.15	3/8	1.63	1.34	0.62	1.19	8.66	1.77	1.02	4.4	
8-027-13	12,000	5.3	1/2	1.81	1.70	0.83	1.57	10.51	2.09	1.19	9.0	
8-027-16	18,100	8.0	5/8	2.36	1.97	0.91	1.93	12.91	2.44	1.42	15.9	
8-027-20	28,300	12.5	3/4	2.91	3.23	1.02	2.36	15.28	3.54	1.91	24.9	
8-027-22	34,200	15.0	7/8	3.82	3.74	1.30	2.48	17.99	3.14	2.12	39.5	
8-027-26	47,700	21.2	1	4.13	4.53	1.65	2.72	21.06	3.90	2.20	62.4	

* Design factor 4:1 proof tested and certified Tested acc. to EN 1677

⚠ WARNING INFORMATION : This hook is a positioning device and is not intended to rotate under load.

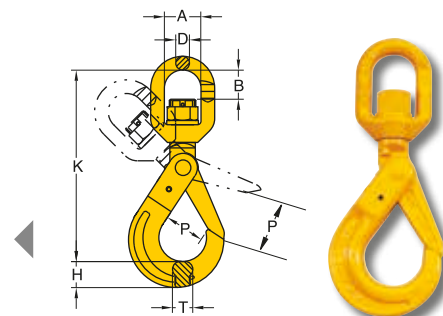

Swivel Self Locking Hooks with Ball Bearing, which performs full swivel underload

Code	Working Load Limit		For chain G80	Dimensions in.								Net Weight lbs
	lbs*	TONS*		in.	A	B	D	H	K	P	T	
8-027N-06	2,500	1.12	7/32	1.26	0.87	0.44	0.75	5.86	1.14	0.59	1.5	
8-027N-07	4,500	2.0	1/4-5/16	1.42	1.14	0.51	0.94	7.32	1.34	0.79	2.6	
8-027N-10	7,100	3.15	3/8	1.63	1.34	0.62	1.19	8.66	1.77	1.02	4.4	
8-027N-13	12,000	5.3	1/2	1.81	1.70	0.83	1.57	10.51	2.09	1.19	9.0	
8-027N-16	18,100	8.0	5/8	2.36	1.97	0.91	1.93	12.91	2.44	1.42	16.1	
8-027N-20	28,300	12.5	3/4	2.91	3.23	1.02	2.36	15.28	3.54	1.91	25.1	
8-027N-22	34,200	15.0	7/8	3.82	3.74	1.30	2.48	17.99	3.14	2.12	39.9	
8-027N-26	47,700	21.2	1	4.13	4.53	1.65	2.72	21.06	3.90	2.20	65.0	

* Design factor 4:1 proof tested and certified Tested acc. to EN 1677

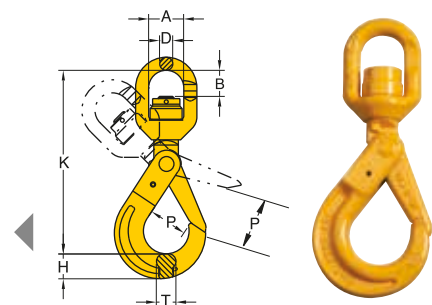

Shank Self Locking Hooks

Code	Working Load Limit		Dimensions in.							Net Weight lbs
	lbs*	TONS*	D	d min.**	H	K	K1	P	T	
8-024-06	2,500	1.12	0.83	0.44	0.75	3.54	1.46	1.14	0.59	1.1
8-024-07	4,500	2.0	1.98	0.51	0.94	4.53	1.69	1.38	0.79	2.0
8-024-10	7,100	3.15	1.14	0.62	1.19	5.31	1.89	1.77	1.02	3.3
8-024-13	12,000	5.3	1.34	0.79	1.57	6.73	2.52	2.09	1.19	6.6
8-024-16	18,100	8.0	1.46	0.98	1.93	8.03	2.95	2.44	1.42	12.1
8-024-20	28,300	12.5	1.69	1.50	2.36	8.62	3.54	3.54	1.91	19.0
8-024-22	34,200	15.0	2.01	1.77	2.48	9.88	4.53	3.14	2.12	26.0
8-024-26	47,700	21.2	2.56	1.97	2.72	10.67	5.94	3.90	2.20	37.2

** d min. = the smallest shank dimension after machining.

Note: After machining the shank, proof loading must be carried out.

* Design factor 4:1

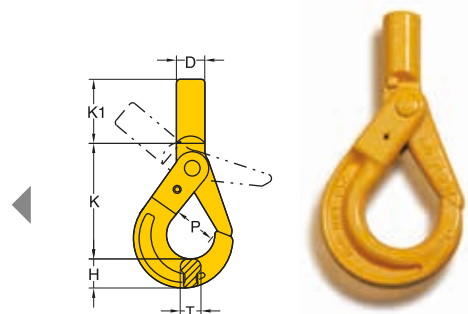

Eye Grab Hooks

Not for use with Omega Link Item. 8-018
No reduction of working load limit, thanks to supporting wings which prevent chain link deformation.

Code	Working Load Limit		For chain G80	Dimensions in.						Net Weight lbs
	lbs*	TONS*		in.	A	F	G	K	P	
8-041-06	2,500	1.12	7/32	0.51	0.98	0.31	2.01	0.31	0.31	0.4
8-041-07	4,500	2.0	1/4-5/16	0.59	1.18	0.35	2.36	0.39	0.7	0.7
8-041-10	7,100	3.15	3/8	0.79	1.61	0.51	3.22	0.51	1.3	1.3
8-041-13	12,000	5.3	1/2	0.98	2.05	0.59	4.02	0.63	3.1	3.1
8-041-16	18,100	8.0	5/8	1.18	2.24	0.79	5.16	0.79	4.9	4.9
8-041-20	28,300	12.5	3/4	1.49	2.87	0.91	5.75	0.91	8.4	8.4
8-041-22	34,200	15.0	7/8	1.50	2.76	1.02	6.42	1.02	10.1	10.1
8-041-26	47,700	21.2	1	1.81	3.94	1.26	8.07	1.14	22.7	22.7
8-041-32	72,300	31.5	1-1/4	2.28	5.00	1.61	10.51	1.53	44.1	44.1

* Design factor 4:1 proof tested and certified. Tested acc. to EN 1677

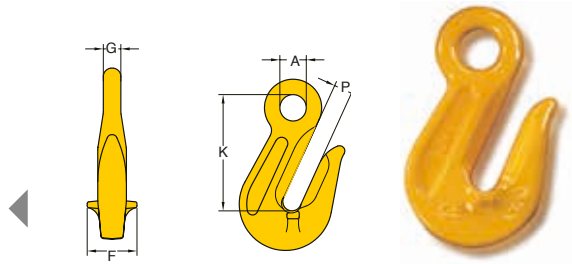

Clutch Sling Hooks - Locking Clutch

Code	Working Load Limit		For chain G80	Dimensions in.								Net Weight lbs
	lbs*	TONS*		in.	A	B	C	H	K	L	P	
8-077-06	2,500	1.12	7/32	0.28	0.28	0.67	0.71	4.00	5.33	0.85	0.61	1.1
8-077-07	4,500	2.0	1/4-5/16	0.38	0.40	0.94	0.93	4.85	6.75	1.04	0.72	1.8
8-077-10	7,100	3.15	3/8	0.47	0.47	1.10	1.34	5.85	8.40	1.32	0.93	3.8
8-077-13	12,000	5.3	1/2	0.60	0.63	1.14	1.46	7.05	10.06	1.71	1.18	7.5
8-077-16	18,100	8.0	5/8	0.80	0.75	1.90	1.66	8.36	12.00	1.80	1.54	12.4

* Design factor 4:1 proof tested and certified. Tested acc. to EN 1677

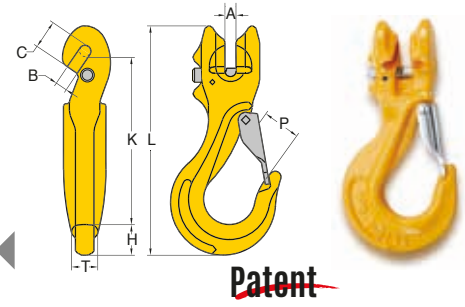

Clevis Grab Hooks

Not for use with Omega Link Item. 8-018
No reduction of working load limit, thanks to supporting wings which prevent chain link deformation.

Code	Working Load Limit		For chain G80	Dimensions in.						Net Weight lb
	lb*	TONS*		in.	A	F	H	K	L	
8-042-06	2,500	1.12	7/32	0.28	0.98	0.63	1.61	3.11	0.31	0.4
8-042-07	4,500	2.0	1/4-5/16	0.35	1.18	0.98	2.17	3.66	0.39	0.7
8-042-10	7,100	3.15	3/8	0.47	1.61	1.38	3.03	5.04	0.51	1.8
8-042-13	12,000	5.3	1/2	0.59	2.09	1.65	3.82	5.98	0.63	3.5
8-042-16	18,100	8.0	5/8	0.67	2.22	1.77	4.47	7.66	0.79	6.2
8-042-20	28,300	12.5	3/4	0.91	3.86	2.13	4.88	8.54	0.91	11.0

* Design factor 4:1 proof tested and certified. Tested acc. to EN 1677

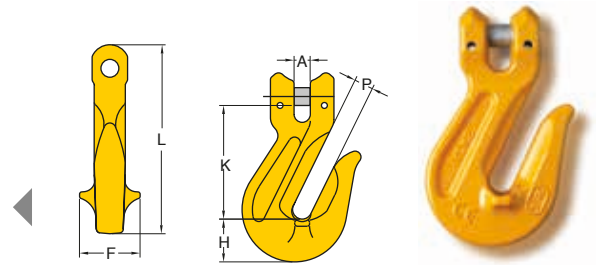

Clevis Sling Hooks, with latch

Code	Working Load Limit		For chain G80	Dimensions in.					Net Weight lb
	lb*	TONS*		in.	A	H	K	P1	
8-043/S-06	2,500	1.12	7/32	0.24	0.70	3.07	0.87	0.59	0.7
8-043/S-07	4,500	2.0	1/4-5/16	0.35	0.91	3.74	1.18	0.75	1.3
8-043/S-10	7,100	3.15	3/8	0.43	1.14	4.72	1.42	0.91	2.6
8-043/S-13	12,000	5.3	1/2	0.55	1.50	5.79	1.73	1.10	5.1
8-043/S-16	18,100	8.0	5/8	0.71	1.65	6.65	1.81	1.54	8.4
8-043/S-20	28,300	12.5	3/4	0.83	2.01	7.87	2.20	1.85	14.8

* Design factor 4:1 proof tested and certified. Tested acc. to EN 1677

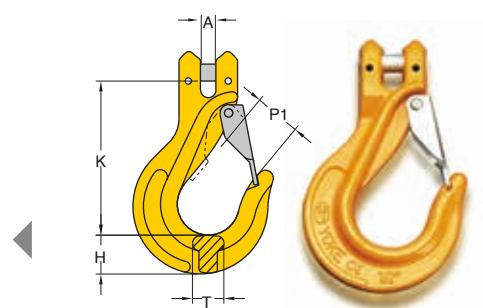

Eye Foundry Hooks

Code	Working Load Limit		For chain G80	Dimensions in.						Net Weight lb
	lb*	TONS*		in.	A	D	H	K	P	
8-047-07	4,500	2.0	1/4-5/16	0.94	0.47	1.18	4.84	2.44	0.79	1.5
8-047-10	7,100	3.15	3/8	1.26	0.59	1.34	5.91	2.87	0.94	2.9
8-047-13	12,000	5.3	1/2	1.56	0.75	1.65	7.09	3.50	1.34	5.3
8-047-16	18,100	8.0	5/8	1.96	0.98	1.97	8.46	3.94	1.63	8.8
8-047-20	28,300	12.5	3/4	2.36	1.10	2.25	9.76	4.41	1.81	20.7

* Design factor 4:1 proof tested and certified Tested acc. to EN 1677

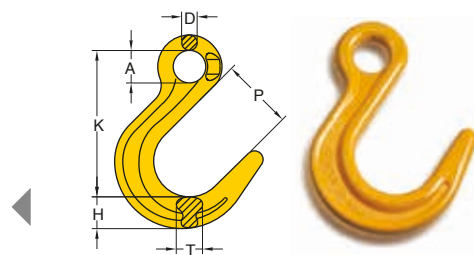

Connecting Links

Code	Working Load Limit		For chain G80	Dimensions in.					Net Weight lb
	lb*	TONS*		in.	A	B	D	K	
8-015-05	1,500	0.8	3/16	0.39	0.51	0.24	1.39	0.08	
8-015-06	2,500	1.12	7/32	0.59	0.67	0.28	1.73	0.2	
8-015-07	4,500	2.0	1/4-5/16	0.71	0.89	0.35	2.25	0.4	
8-015-10	7,100	3.15	3/8	0.99	1.06	0.50	2.68	0.7	
8-015-13	12,000	5.3	1/2	1.19	1.38	0.62	3.58	1.5	
8-015-16	18,100	8.0	5/8	1.42	1.51	0.75	3.94	2.4	
8-015-20	28,300	12.5	3/4	1.65	1.81	0.87	4.80	4.2	
8-015-22	34,200	15.0	7/8	1.93	2.32	0.94	5.98	6.6	
8-015-26	47,700	21.2	1	2.17	2.44	1.19	6.38	10.4	
8-015-32	72,300	31.5	1-1/4	2.72	3.11	1.42	7.96	19.4	

* Design factor 4:1 proof tested and certified Tested acc. to EN 1677

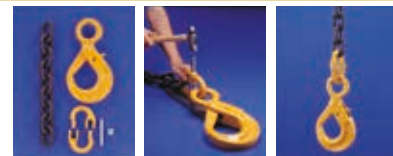

ABS

Type Approval

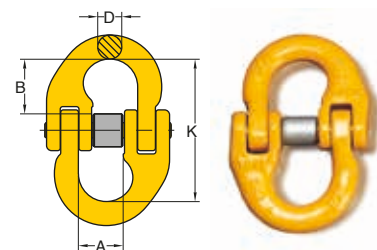

Closed Coupling Master Links

Code	Working Load Limit		For chain G80	Dimensions in.				Net Weight lb
	lb*	TONS*		in.	D	d min.**	L1	
8-050-07	4,500	2.0	1/4-5/16	1.18	0.51	2.72	0.91	1.1
8-050-10	7,100	3.15	3/8	1.38	0.63	2.76	1.26	1.5
8-050-13	12,000	5.3	1/2	1.65	0.78	4.13	1.54	3.5
8-050-16	18,100	8.0	5/8	1.97	0.98	4.72	1.81	5.7
8-050-20	28,300	12.5	3/4	2.95	1.18	3.54	2.32	12.4

** d min.: the smallest shank dimension after machining.

Note: After machining the shank, proof loading must be carried out.

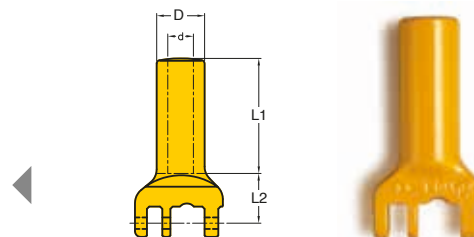

Shortening Clutch with Half Link

Code	Working Load Limit		For chain G80	Dimensions in.								Net Weight lb
	lb*	TONS*		in.	A	C	D	E	F	G	H	
8-078-07	4,500	2.0	1/4-5/16	0.47	0.79	0.39	0.91	2.76	0.89	0.35	5.04	1.5
8-078-10	7,100	3.15	3/8	0.51	1.02	0.47	1.14	3.43	1.06	0.50	6.06	2.9
8-078-13	12,000	5.3	1/2	0.59	1.30	0.63	1.46	4.53	1.38	0.62	7.99	6.2
8-078-16	18,100	8.0	5/8	0.83	1.54	0.75	1.81	5.63	1.51	0.75	9.76	11.7

* Design factor 4:1 proof tested and certified Tested acc. to EN 1677

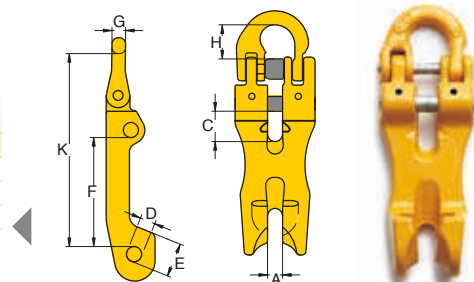

Clevis Clutch - Locking Type

Code	Working Load Limit		For chain G80	Dimensions in.						Net Weight lbs
	lbs*	TONS*		in.	A	B	C	D	E	
8-061-06	2,500	1.12	7/32	0.28	0.28	0.39	0.28	0.71	1.97	0.7
8-061-07	4,500	2.0	1/4-5/16	0.37	0.37	0.40	0.39	0.94	2.22	1.1
8-061-10	7,100	3.15	3/8	0.47	0.45	0.45	0.47	1.10	2.59	2.0
8-061-13	12,000	5.3	1/2	0.59	0.59	0.63	0.63	1.54	3.46	4.6
8-061-16	18,100	8.0	5/8	0.71	0.83	0.72	0.75	1.90	4.06	8.2
8-061-20	28,300	12.5	3/4	0.91	0.91	0.91	0.83	2.17	5.18	12.6

* Design factor 4:1 proof tested and certified Tested acc. to EN 1677

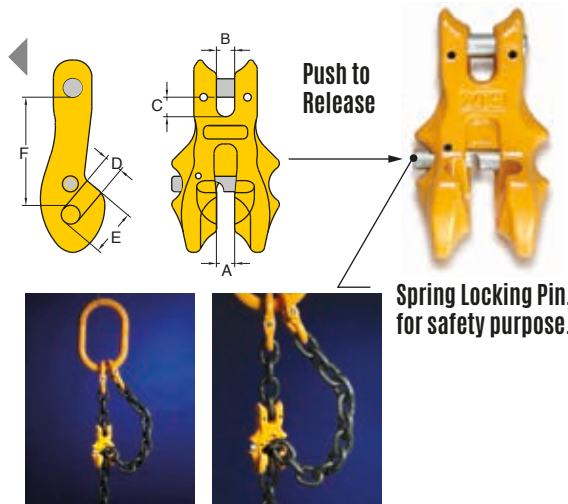

Clevis Master Links

Code	Working Load Limit		For chain G80	Dimensions in.						Net Weight lbs
	lbs*	TONS*		in.	A	G	H	K	L	
8-059-07	4,500	2.0	1/4-5/16	0.35	2.56	0.59	3.90	3.15	0.59	0.9
8-059-10	7,100	3.15	3/8	0.43	3.15	0.71	4.92	3.94	0.75	1.8
8-059-13	12,000	5.3	1/2	0.55	4.25	0.87	6.62	5.35	0.98	3.3
8-059-16	18,100	8.0	5/8	0.71	4.88	1.02	7.80	6.50	1.07	5.3

* Design factor 4:1 proof tested and certified. Tested acc. to EN 1677

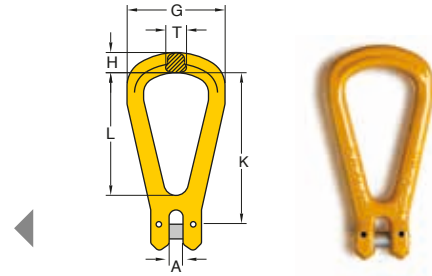

Coupling Master Links

Code	Working Load Limit		For chain G80	Dimensions in.					Net Weight lbs
	lbs*	TONS*		in.	A	H	K	T	
8-051-07	4,500	2.0	1/4-5/16	0.59	0.59	3.94	0.59	1.97	0.7
8-051-10	7,100	3.15	3/8	0.79	0.75	5.00	0.75	2.56	1.5
8-051-13	12,000	5.3	1/2	0.98	0.87	5.71	0.93	2.83	2.2
8-051-16	18,100	8.0	5/8	1.18	1.02	6.85	0.98	3.15	3.5
8-051-20	28,300	12.5	3/4	1.42	1.42	7.95	1.22	4.09	6.6

* Design factor 4:1 proof tested and certified. Tested acc. to EN 1677

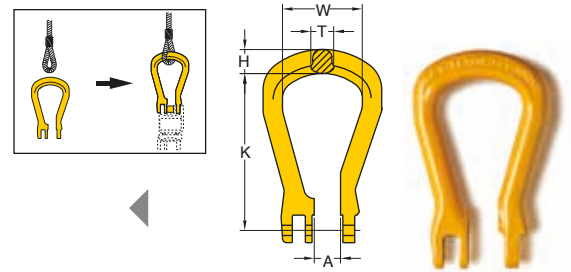

Coupling Sling Hooks

Code	Working Load Limit		For chain G80	Dimensions in.				Net Weight lbs
	lbs*	TONS*		in.	H	K	P	
8-055-07	4,500	2.0	1/4-5/16	0.91	3.66	1.18	0.75	0.9
8-055-10	7,100	3.15	3/8	1.22	4.53	1.42	0.91	2.0
8-055-13	12,000	5.3	1/2	1.42	5.55	1.65	1.10	4.0
8-055-16	18,100	8.0	5/8	1.77	6.54	1.85	1.26	6.6
8-055-20	28,300	12.5	3/4	1.89	7.52	2.05	1.69	10.4

* Design factor 4:1 proof tested and certified. Tested acc. to EN 1677

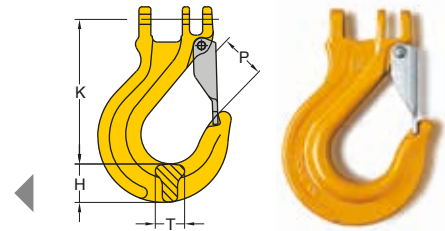

Round Slings Coupling

Code	Working Load Limit		For chain G80	Dimensions in.				Net Weight lbs
	lbs*	TONS*		in.	A	B	K	
8-053-06	2,500	1.12	7/32	0.59	0.87	1.30	1.54	0.4
8-053-07	4,500	2.0	1/4-5/16	0.71	0.94	1.30	1.57	0.4
8-053-10	7,100	3.15	3/8	0.98	1.14	1.65	1.85	0.9
8-053-13	12,000	5.3	1/2	1.18	1.38	2.01	2.09	1.5
8-053-16	18,100	8.0	5/8	1.42	1.73	2.48	2.64	2.9
8-053-20	28,300	12.5	3/4	1.65	2.05	2.87	3.15	4.6
8-053-22	34,200	15.0	7/8	1.97	2.83	4.37	4.92	12.6
8-053-26	47,700	21.2	1	2.17	3.39	5.08	5.91	20.1
8-053-32	72,300	31.5	1-1/4	2.72	3.35	6.50	7.48	29.5

* Design factor 4:1 proof tested and certified.

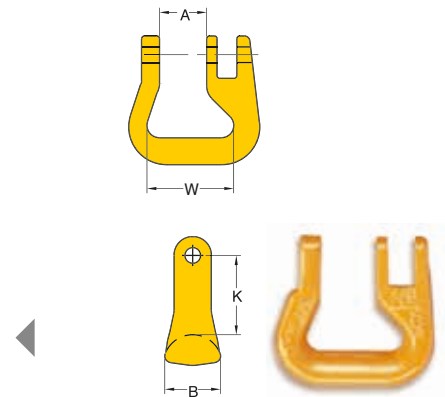

Web Slings Connector

Code	Working Load Limit		For chain G80	Dimensions in.					Net Weight lb
	lbs*	TONS*		in.	A	B	D	K	
8-016-06	2,500	1.12	7/32	0.59	0.67	0.28	2.16	1.54	0.4
8-016-07	4,500	2.0	1/4-5/16	0.71	0.89	0.35	2.44	1.57	0.7
8-016-10	7,100	3.15	3/8	0.99	1.06	0.50	3.07	1.85	1.3
8-016-13	12,000	5.3	1/2	1.19	1.38	0.62	3.74	2.09	2.4
8-016-16	18,100	8.0	5/8	1.42	1.51	0.75	4.53	2.64	4.4
8-016-20	28,300	12.5	3/4	1.65	1.81	0.87	5.20	3.15	7.1
8-016-22	34,200	15.0	7/8	1.93	2.32	0.94	7.36	4.92	16.3
8-016-26	47,700	21.2	1	2.17	2.44	1.19	8.23	5.91	25.3
8-016-32	72,300	31.5	1-1/4	2.72	3.11	1.42	10.98	7.48	40.6

* Design factor 4:1 proof tested and certified. Tested acc. to EN 1677

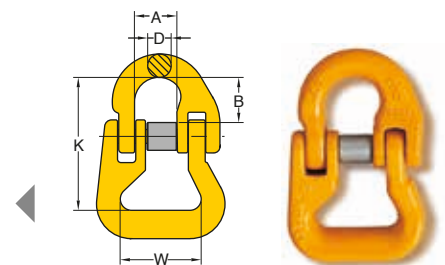

Eye Container Hooks

Code	DSC.	Working Load Limit		Dimensions in.						Net Weight lbs
		lbs*	TONS*	E	F	G	H	K	T	
8-067-STR	Right	28,000	12.5	2.76	1.81	2.95	1.89	7.56	0.98	8.6
8-067-45LT	Left 45°	28,000	12.5	2.76	1.81	2.95	1.89	7.56	0.98	8.6
8-067-45RH	Right 45°	28,000	12.5	2.76	1.81	2.95	1.89	7.56	0.98	8.6

* Design factor 4:1 proof tested and certified.

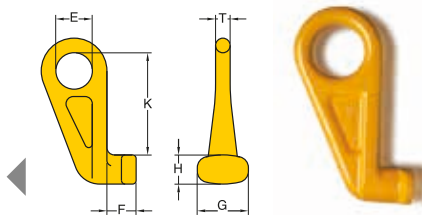

8-067-45LT

8-067-45RH

8-067-STR



Sliding Choke Hooks

Code	Working Load Limit		For cable size in.	Dimensions in.					Net Weight lbs
	lbs*	TONS*		A	E	H	P	S	
8-074-09/13	3,300	1.5	3/8	0.63	3.43	0.94	0.71	0.71	1.3
8-074-14/16	4,850	2.2	9/16	0.83	3.86	1.14	0.79	0.87	2.0

* Design factor 5 : 1

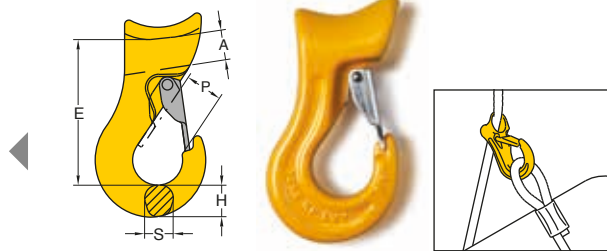

Round Sling Self Locking Hooks

Code	Working Load Limit		For chain G80 in.	Dimensions in.					Net Weight lbs
	lbs*	TONS*		H	K	P	T	W	
8-028-06	2,500	1.12	7/32	0.75	5.43	1.14	0.59	1.54	1.3
8-028-07	4,500	2.0	1/4-5/16	0.94	6.65	1.34	0.79	1.57	2.4
8-028-10	7,100	3.15	3/8	1.19	7.72	1.77	1.02	1.85	4.0
8-028-13	12,000	5.3	1/2	1.57	9.96	2.13	1.19	2.09	7.9
8-028-16	18,100	8.0	5/8	1.93	12.00	2.44	1.42	2.64	15.2
8-028-20	28,300	12.5	3/4	2.36	12.91	3.54	1.91	3.15	23.6
8-028-22	34,200	15.0	7/8	2.48	16.38	3.14	2.12	4.92	39.0
8-028-26	47,700	21.2	1	2.72	18.07	3.90	2.20	5.91	53.1

* Design factor 4:1 proof tested and certified.

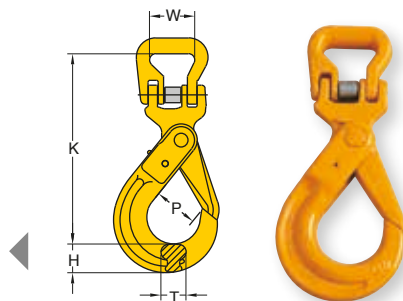

YOKE Roundsling Self Locking Hook is designed in a way to solve your synthetic end-fitting problems. The Roundsling Self Locking Hook presents following utmost benefits :

- 1.The Round Shape is designed to provide great protection to your synthetic roundsling on everyloading.
- 2.Offer complete range of hooks from 1 tonnes up to 21.2 tonnes.
- 3.Assembly is fast and easy with only a hammer required.
- 4.The hook with Self Locking function meets real safe and safer required.
- 5.Acquired  certificate approved by BG

German company. 

INNOVATION



- Quenched and Tempered Alloy Steel.
- At least 25% greater WLL than traditional G80 products.
- Manufactured in accordance with EN 1677- 3 and ASME B30.26.
- Proof Load tested at 2.5 times the WLL with certification for each batch manufactured.

- Design Factor 4:1.
- Fatigue rated to 20,000 cycles at 1.5 times the WLL.
- Tempering temperature minimum 400°C
- Magnaflux crack detection is performed 100% on each batch.

G-100 Eye Self Locking Hooks

Code	For chain G100		Working Load Limit	Dimensions in.						Net Weight lbs
	in.	lbs*		TONS*	A	D	H	K	P	
X-025-06	7/32	3,200	1.4	0.83	0.39	0.87	4.33	1.10	0.59	1.1
X-025-07	1/4-5/16	5,700	2.5	0.98	0.43	1.02	5.35	1.34	0.79	1.8
X-025-10	3/8	8,800	4.0	1.26	0.51	1.34	6.57	1.73	1.02	3.3
X-025-13	1/2	15,000	6.7	1.57	0.63	1.65	8.15	2.01	1.18	6.6
X-025-16	5/8	22,600	10.0	1.97	0.83	2.20	9.92	2.36	1.42	12.8
X-025-20	3/4	35,300	16.0	2.36	0.91	2.56	11.42	2.76	2.09	22.0
X-025-22	7/8	42,700	19.0	2.76	0.94	2.80	12.56	3.15	1.93	27.5
X-025-26	1	59,700	26.5	3.15	0.98	3.11	13.50	3.90	2.20	33.0

* Design factor 4:1 proof tested and certified.

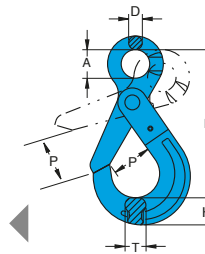

G-100 Clevis Self Locking Hooks

Code	For chain G100		Working Load Limit	Dimensions in.					Net Weight lbs
	in.	lbs*		A	H	K	P	T	
X-026-06	7/32	3,200	1.4	0.27	0.87	3.66	1.10	0.59	1.1
X-026-07	1/4-5/16	5,700	2.5	0.40	1.02	4.69	1.34	0.79	1.8
X-026-10	3/8	8,800	4.0	0.48	1.34	5.59	1.73	1.02	3.3
X-026-13	1/2	15,000	6.7	0.60	1.65	7.01	2.01	1.18	6.6
X-026-16	5/8	22,600	10.0	0.73	2.20	8.39	2.36	1.42	12.5
X-026-20	3/4	35,300	16.0	0.86	2.56	9.61	2.76	2.09	22.5
X-026-22	7/8	42,700	19.0	0.99	2.80	10.75	3.15	1.93	24.0

* Design factor 4:1 proof tested and certified.

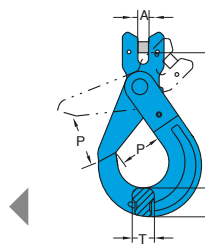

G-100 Swivel Self Locking Hooks With Brass Bushing

Code	For chain G100		Working Load Limit	Dimensions in.						Net Weight lbs
	in.	lbs*		A	D	H	K	P	T	
X-027-06	7/32	3,200	1.4	1.26	0.87	0.47	5.87	0.87	1.10	1.3
X-027-07	1/4-5/16	5,700	2.5	1.42	1.14	0.51	7.32	1.02	1.34	2.6
X-027-10	3/8	8,800	4.0	1.61	1.34	0.63	8.58	1.34	1.73	4.4
X-027-13	1/2	15,000	6.7	1.81	1.69	0.83	10.87	1.65	2.01	9.0
X-027-16	5/8	22,600	10.0	2.40	1.97	0.91	12.95	2.20	2.36	15.0
X-027-20	3/4	35,300	16.0	2.91	3.23	0.98	15.24	2.56	2.76	27.8
X-027-22	7/8	42,700	19.0	3.82	3.74	1.30	17.99	2.80	3.15	39.6
X-027-26	1	59,700	26.5	4.84	4.53	2.01	21.06	3.11	3.90	69.3

* Design factor 4:1 proof tested and certified.

⚠ WARNING INFORMATION : This hook is a positioning device and is not intended to rotate under load. For swivel hooks designed to rotate under load, see X-027N.

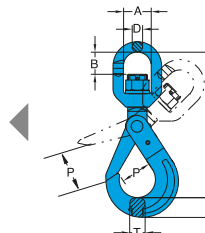

Also available with ball bearing.
Part number : X-027N-__



- Quenched and Tempered Alloy Steel.
- At least 25% greater WLL than traditional G80 products.
- Manufactured in accordance with EN 1677- 1 and ASTM A952/ A952M, DIN PAS 1061.

- Proof Load tested at 2.5 times the WLL with certification for each batch manufactured.
- Design Factor 4:1.
- Fatigue rated to 20,000 cycles at 1.5 times the WLL.
- Suitable for use with both Grade 80 and Grade 100 chain.

G-100 Connecting Links

Code	For chain G100		Working Load Limit		Dimensions in.				Net Weight
	in.	lbs*	TONS*	A	B	D	K	lbs	
X-015-06	7/32	3,200	1.4	0.59	0.71	0.28	1.77	0.2	
X-015-07	1/4-5/16	5,700	2.5	0.71	0.98	0.35	2.32	0.4	
X-015-10	3/8	8,800	4.0	0.98	1.10	0.43	2.72	0.7	
X-015-13	1/2	15,000	6.7	1.18	1.50	0.63	3.62	1.5	
X-015-16	5/8	22,600	10.0	1.42	1.61	0.75	3.98	2.6	
X-015-20	3/4	35,300	16.0	1.65	1.97	0.91	4.80	4.6	
X-015-22	7/8	42,700	19.0	1.93	2.48	0.95	5.98	7.7	
X-015-26	1	59,700	26.5	2.17	2.60	1.18	6.38	10.6	
X-015-32	1-1/4	90,400	40.0	2.72	3.35	1.42	7.99	19.8	

* Design factor 4:1 proof tested and certified.

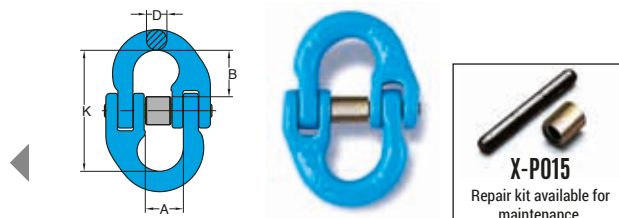

- Quenched and Tempered Alloy Steel.
- At least 25% greater WLL than traditional G80 products.
- Manufactured in accordance with ASTM A906/A906M, ASTMA952/A952M, ASME B30.9, ASME B30.10, ASME B30.26 and OHS 1910.184, EN-1677-4.
- Proof Load tested at 2.5 times the WLL with certification for each batch manufactured.

- Design Factor 4:1.
- Fatigue rated to 20,000 cycles at 1.5 times the WLL.
- Tempering temperature at a minimum of 400°C.
- Designed for Wire Rope and Chain.
- Each link is marked with batch number that links to the test certificate with full traceability to raw materials.

G-100 Forged Oblong Master Links

Code	For chain G100		Working Load Limit β 0-45°	Charge de test	Dimensions in.			Net Weight
	Simple	Double			D	A	B	
X-003-06	7/32		1.4	34	0.43	3.94	2.36	0.4
X-003-0806	1/4-5/16	7/32	2.9	71	0.55	4.72	2.76	1.1
X-003-1008	3/8	1/4-5/16	5.3	130	0.67	5.51	3.15	1.5
X-003-13	1/2		6.7	164	0.75	5.91	3.54	2.4
X-003-1310	1/2	3/8	8.4	206	0.87	6.30	3.74	3.3
X-003-16	5/8		10.0	245	0.98	7.48	4.33	5.1
X-003-1613	5/8	1/2	14.1	345	1.10	7.09	4.13	5.9
X-003-19	3/4		16.0	392	1.18	7.87	4.72	7.7
X-003-2216	7/8	5/8	21.0	515	1.34	9.45	5.51	11.7
X-003-26	1		26.5	649	1.50	9.84	5.91	16.3
X-003-2619	1	3/4	33.6	823	1.57	9.84	5.91	18.3
X-003-3222	1-1/4	7/8	39.9	978	1.77	11.81	7.09	27.1

* Design factor 4:1 proof tested and certified.

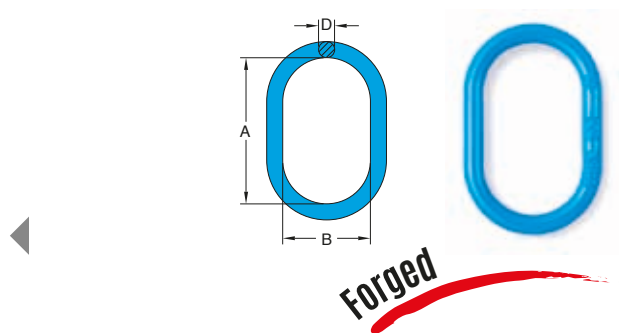

Ben-Mor received an award at 2018 YOKE Worldwide Partner Summit in recognition of his outstanding support and successful partnership with YOKE.

- Quenched and Tempered Alloy Steel.
- At least 25% greater WLL than traditional G80 products.
- Manufactured in accordance with EN 1677- 2 and ASME B30.26.
- Proof Load tested at 2.5 times the WLL with certification for each batch manufactured.

- Design Factor 4:1.
- Fatigue rated to 20,000 cycles at 1.5 times the WLL.
- Tempering temperature minimum 400°C
- Magnaflux crack detection is performed 100% on each batch.

G-100 Eye Sling Hooks with Latch

Code	For chain G100		Working Load Limit	Dimensions in.							Net Weight lbs
	in.	lbs*		TONS*	A	D	H	K	P	T	
X-044/S-06	7/32	3,200	1.4	0.79	0.39	0.75	3.15	0.91	0.67	0.7	
X-044/S-07	1/4-5/16	5,700	2.5	0.98	0.47	0.91	3.86	1.10	0.79	1.1	
X-044/S-10	3/8	8,800	4.0	1.26	0.59	1.22	4.76	1.42	0.91	2.2	
X-044/S-13	1/2	15,000	6.7	1.57	0.71	1.50	5.98	1.58	1.06	4.0	
X-044/S-16	5/8	22,600	10.0	1.97	0.87	1.77	7.28	1.73	1.26	6.8	
X-044/S-20	3/4	35,300	16.0	2.44	1.06	2.51	9.05	2.13	1.89	16.0	
X-044/S-22	7/8	42,700	19.0	2.01	1.22	2.48	9.65	2.99	2.05	20.5	
X-044/S-26	1	59,700	26.5	2.56	1.38	3.07	11.22	3.03	2.36	28.6	
X-044/S-32	1-1/4	90,400	40.0	3.45	1.57	3.15	13.86	4.49	2.56	37.4	

* Design factor 4:1 proof tested and certified.

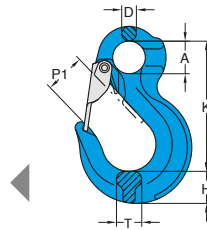

G-100 Clevis Sling Hooks with Latch

Code	Working Load Limit		For chain G100	Dimensions in.							Net Weight lbs
	lbs*	TONS*		in.	A	H	K	P1	T	T	
X-043/S-06	3,200	1.4	7/32	0.24	0.91	0.91	3.82	0.59	0.67	0.7	
X-043/S-07	5,700	2.5	1/4-5/16	0.35	0.87	1.06	3.86	0.71	0.79	1.1	
X-043/S-10	8,800	4.0	3/8	0.43	1.18	1.34	4.80	0.94	0.91	2.2	
X-043/S-13	15,000	6.7	1/2	0.55	1.46	1.73	5.79	1.18	1.06	4.0	
X-043/S-16	22,600	10.0	5/8	0.67	1.65	1.89	6.54	1.54	1.26	6.8	
X-043/S-20	35,300	16.0	3/4	0.94	2.52	2.24	8.15	1.89	1.89	16.0	
X-043/S-22	42,700	7/8	19.0	2.01	1.22	9.65	2.48	2.99	2.05	20.5	

* Design factor 4:1 proof tested and certified.

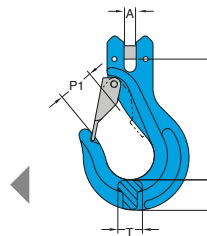

G-100 Alloy Swivel Hoist Hooks with Brass Washer

Code	Hook Feature Code	Working Load Limit		For chain G100	Dimensions in.											Net Weight lbs
		lbs*	TONS*		in.	A	B	C	D	G	H	K	L	P	P1	
8-175-015	BB	3,300	1.5	7/32	1.26	0.91	0.97	0.45	3.15	0.84	4.96	6.23	0.95	0.75	0.71	1.5
8-175-02	CC	4,400	2.0	1/4-5/16	1.42	1.14	1.03	0.49	3.66	1.00	5.63	7.15	1.06	0.79	0.88	2.0
8-175-03	DD	6,600	3.0	3/8	1.62	1.38	1.16	0.63	4.02	1.13	7.73	8.36	1.22	0.98	0.95	3.3
8-175-05	EE	11,000	5.0	1/2	1.83	1.73	1.53	0.83	5.14	1.41	8.32	10.58	1.42	1.22	1.22	7.0
8-175-07	FF	15,400	7.0	5/8	2.40	1.99	1.94	0.89	6.60	1.82	10.18	12.92	1.77	1.54	1.42	12.5
8-175-11	GG	24,200	11.0	3/4	2.92	3.25	2.46	0.99	7.72	2.28	12.84	16.11	2.40	2.24	1.89	21.2
8-175-15	HH	33,000	15.0	7/8	3.83	3.78	2.59	1.30	8.70	2.53	14.64	18.55	2.83	2.44	2.20	35.1

* Design factor 5:1 proof tested and certified.

⚠ WARNING INFORMATION : This hook is a positioning device and is not intended to rotate under load. For swivel hooks designed to rotate under load, see 8-175N.

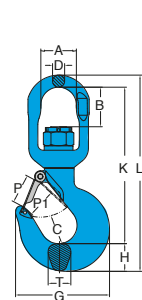

G-100 Alloy Eye Hoist Hooks with Latch

Code	Hook Feature Code	Working Load Limit		For chain G100	Dimensions in.							Net Weight lbs	
		lbs*	TONS*		in.	A	D	d	H	K	P		P1
8-173-015	BB	3,300	1.5	7/32	0.91	0.75	0.43	0.83	3.74	0.95	0.75	0.67	0.9
8-173-02	CC	4,400	2.0	1/4-5/16	1.14	0.79	0.51	1.02	4.17	1.06	0.79	0.83	1.5
8-173-03	DD	6,600	3.0	3/8	1.26	0.98	0.59	1.14	4.80	1.22	0.98	0.95	2.0
8-173-05	EE	11,000	5.0	1/2	1.57	1.22	0.71	1.46	5.87	1.42	1.22	1.22	4.6
8-173-07	FF	15,400	7.0	5/8	2.00	1.54	0.95	1.85	7.56	1.77	1.54	1.46	8.8
8-173-11	GG	24,200	11.0	3/4	2.44	2.24	1.10	2.28	9.13	2.40	2.24	1.89	15.2
8-173-15	HH	33,000	15.0	7/8	2.84	2.44	1.26	2.60	10.10	2.83	2.44	2.20	22.0

* Design factor 5:1 proof tested and certified.

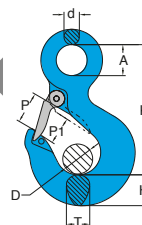

- Quenched and Tempered Alloy Steel.
- At least 25% greater WLL than traditional G80 products.
- Manufactured in accordance with EN 1677- 2 and ASME B30.26.
- Proof Load tested at 2.5 times the WLL with certification for each batch manufactured.

- Design Factor 4:1.
- Fatigue rated to 20,000 cycles at 1.5 times the WLL.
- Tempering temperature minimum 400°C
- Magnaflux crack detection is performed 100% on each batch.
- Built with ball bearing and enables full swivel feature under load.

G-100 Alloy Swivel Bearing Hoist Hooks with Ball Bearing, which performs full swivel under load.

Code	Hook Feature Code	Working Load Limit		For chain G100 in.	Dimensions in.										Net Weight lbs	
		lbs*	TONS*		A	B	C	D	G	H	K	L	P	P1		T
8-175N-015	BB	3,300	1.5	7/32	1.26	0.91	0.97	0.45	3.15	0.84	4.96	6.23	0.95	0.75	0.71	1.5
8-175N-02	CC	4,400	2.0	1/4-5/16	1.42	1.14	1.03	0.49	3.66	1.00	5.63	7.15	1.06	0.79	0.88	2.0
8-175N-03	DD	6,600	3.0	3/8	1.62	1.38	1.16	0.63	4.02	1.13	7.73	8.36	1.22	0.98	0.95	3.3
8-175N-05	EE	11,000	5.0	1/2	1.83	1.73	1.53	0.83	5.14	1.41	8.32	10.58	1.42	1.22	1.22	7.0
8-175N-07	FF	15,400	7.0	5/8	2.40	1.99	1.94	0.89	6.60	1.82	10.18	12.92	1.77	1.54	1.42	12.5
8-175N-11	GG	24,200	11.0	3/4	2.92	3.25	2.46	0.99	7.72	2.28	12.84	16.11	2.40	2.24	1.89	21.2
8-175N-15	HH	33,000	15.0	7/8	3.83	3.78	2.59	1.30	8.70	2.53	14.64	18.55	2.83	2.44	2.20	36.3

* Design factor 5:1 proof tested and certified.

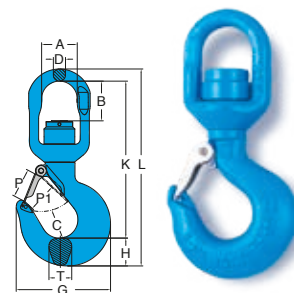

- Quenched and Tempered Alloy Steel.
- At least 25% greater WLL than traditional G80 products.
- Testing according to DIN PAS 1061 and ASTM A952/A 952M
- Proof Load tested at 2.5 times the WLL with certification for each batch manufactured.
- Design Factor 4:1.

- Fatigue rated to 20,000 cycles at 1.5 times the WLL.
- Tempering temperature minimum 400°C
- Not used for general chain sling applications, rather for use where a large throat opening is necessary.
- Before using the hook, check whether hooks without safety latches are allowed to be used for the particular application.

G-100 Eye Foundry Hooks

Code	Working Load Limit		For chain G100 in.	Dimensions in.						Net Weight lbs
	lbs*	TONS*		A	D	H	K	P	T	
X-047-07	5,700	2.5	1/4-5/16	0.94	0.47	1.06	4.84	2.44	0.75	1.8
X-047-10	8,800	4.0	3/8	1.26	0.59	1.26	5.87	2.91	0.91	3.5
X-047-13	15,000	6.7	1/2	1.57	0.75	1.54	7.09	3.46	1.26	5.5
X-047-16	22,600	10.0	5/8	1.97	0.98	1.85	8.39	3.86	1.61	9.7
X-047-20	35,300	16.0	3/4	2.36	1.02	2.24	9.76	4.45	1.81	20.5

* Design factor 4:1 proof tested and certified.

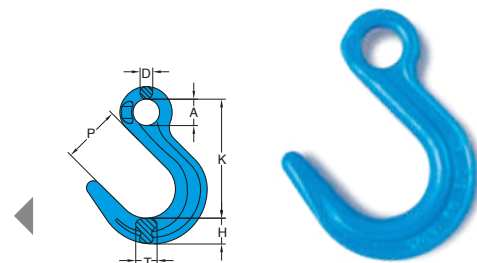

- Quenched and Tempered Alloy Steel.
- At least 25% greater WLL than traditional G80 products.
- Testing according to DIN PAS 1061 and ASTM A952/A 952M
- Proof Load tested at 2.5 times the WLL with certification for each batch manufactured.
- Design Factor 4:1.

- Fatigue rated to 20,000 cycles at 1.5 times the WLL.
- Tempering temperature minimum 400°C
- Not for use with Omega Link
- Enables full WLL while in use, thanks to supporting wings which prevent chain link deformation.

G-100 Clevis Grab Hooks

Code	Working Load Limit		For chain G100 in.	Dimensions in.						Poids net lb
	lbs*	TONS*		A	F	H	K	L	P	
X-042-06	3,200	1.4	7/32	0.28	0.98	0.71	1.85	3.11	0.32	0.4
X-042-07	5,700	2.5	1/4-5/16	0.39	1.18	0.87	2.17	3.66	0.39	0.9
X-042-10	8,800	4.0	3/8	0.43	1.61	1.14	3.03	5.04	0.51	1.7
X-042-13	15,000	6.7	1/2	0.59	2.05	1.50	3.90	6.50	0.67	3.5
X-042-16	22,600	10.0	5/8	0.71	2.24	1.77	4.49	7.68	0.83	6.0
X-042-20	35,300	16.0	3/4	0.87	2.87	2.05	5.12	8.74	0.91	9.9
X-042-22	42,700	19.0	22	0.98	1.65	2.20	5.47	9.72	1.06	13.9

* Design factor 4:1 proof tested and certified.

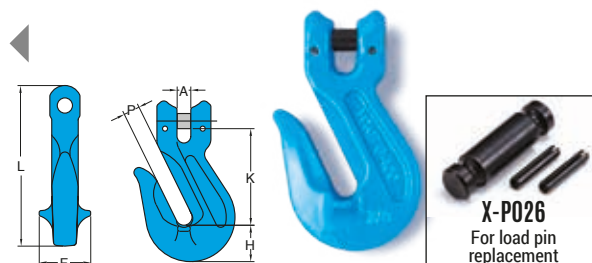

- YOKE Light Snatch Blocks are manufactured of the highest quality tensile steel.
- Available from 2 tons to 8 tons, for wire rope sizes 8mm to 19mm.
- Part number, wire rope size and working load limit are marked on each block.
- Permanent batch codes link to test certificates for easy traceability.
- Supplied with bronze bushings and 4.5"-14" with pressure lube fittings.

- Meets or exceeds all requirements of ASME B30.26.
- Safety factor 4:1
- Fatigue rated



✓ Sheave by Closed Die Forged Steel

Light Snatch Block with Hooks

Code	Sheave Dia. in.	Bearing Type	Wire Rope	Working Load Limit	Net Weight		Replacement Sheave
			mm	TONS*	lbs	kg	
8-502-02	3	BB	8-10	2	7	3	8-500-02
8-502-04	4.5	BB	10-13	4	13	6	8-500-04
8-502-08	6	BB	16-19	8	29	13	8-500-08
8-502-0808	8	BB	16-19	8	42	19	8-500-0808
8-502-0810	10	BB	16-19	8	45	21	8-500-0810
8-502-0812-16	12	BB	16	8	48	22	8-500-0812-16
8-502-0812-19	12	BB	19	8	48	22	8-500-0812-19
8-502-0814-16	14	BB	16	8	55	25	8-500-0814-16
8-502-0814-19	14	BB	19	8	55	25	8-500-0814-19

*Minimum Ultimate Load is 4 times the Working Load Limit.



Light Snatch Blocks with Shackle

Code	Sheave Dia. in.	Bearing Type	Wire Rope	Working Load Limit	Net Weight		Replacement Sheave
			mm	TONS*	lbs	kg	
8-501-02	3	BB	8-10	2	4	2	8-500-02
8-501-04	4.5	BB	10-13	4	13	6	8-500-04
8-501-08	6	BB	16-19	8	29	13	8-500-08
8-501-0808	8	BB	16-19	8	44	20	8-500-0808
8-501-0810	10	BB	16-19	8	46	21	8-500-0810
8-501-0812-16	12	BB	16	8	49	22	8-500-0812-16
8-501-0812-19	12	BB	19	8	49	22	8-500-0812-19
8-501-0814-16	14	BB	16	8	56	25	8-500-0814-16
8-501-0814-19	14	BB	19	8	56	25	8-500-0814-19

*Minimum Ultimate Load is 4 times the Working Load Limit.



8-501-02
8-501-04



8-501-08
and up

Light Tail Boards

Code	Sheave Dia. in.	Bearing Type	Wire Rope	Working Load Limit	Net Weight		Replacement Sheave
			mm	TONS*	lbs	kg	
8-503-02	3	BB	8-10	2	4	2	8-500-02
8-503-04	4.5	BB	10-13	4	8	4	8-500-04
8-503-08	6	BB	16-19	8	15	7	8-500-08
8-503-0808	8	BB	16-19	8	28	13	8-500-0808
8-503-0810	10	BB	16-19	8	29	13	8-500-0810
8-503-0812-16	12	BB	16	8	36	16	8-500-0812-16
8-503-0812-19	12	BB	19	8	36	16	8-500-0812-19
8-503-0814-16	14	BB	16	8	43	20	8-500-0814-16
8-503-0814-19	14	BB	19	8	43	20	8-500-0814-19

*Minimum Ultimate Load is 4 times the Working Load Limit.



- YOKE Forged Snatch Blocks are manufactured of the highest quality forged alloy steel.
- Available from 12 tons to 15 tons, for wire rope sizes 19mm to 22mm.
- Part number, wire rope size and working load limit are marked on each block.
- Permanent batch codes link to test certificates for easy traceability.
- Supplied with bronze bushings and pressure lube fittings.

- Meets or exceeds all requirements of ASME B30.26.
- Safety factor 4:1
- Fatigue rated



✓ Sheave by Closed Die Forged Steel

Forged Snatch Blocks with Hook

Code	Sheave Dia. in.	Bearing Type	Wire Rope	Working Load Limit	Net Weight		Replacement Sheave
			mm	TONS*	lbs	kg	
8-542-12	6	BB	19-22	12	48	22	8-500-12
8-542-15	8	BB	19-22	15	64	29	8-500-15
8-542-1510	10	BB	19-22	15	92	42	8-500-1510

*Minimum Ultimate Load is 4 times the Working Load Limit.



Forged Snatch Blocks with Shackle

Code	Sheave Dia. in.	Bearing Type	Wire Rope	Working Load Limit	Net Weight		Replacement Sheave
			mm	TONS*	lbs	kg	
8-541-12	6	BB	19-22	12	52	24	8-500-12
8-541-15	8	BB	19-22	15	61	28	8-500-15
8-541-1510	10	BB	19-22	15	90	41	8-500-1510

*Minimum Ultimate Load is 4 times the Working Load Limit.



Forged Tail Boards

Code	Sheave Dia. in.	Bearing Type	Wire Rope	Working Load Limit	Net Weight		Replacement Sheave
			mm	TONS*	lbs	kg	
8-543-12	6	BB	19-22	12	29	14	8-500-12
8-543-15	8	BB	19-22	15	38	17	8-500-15
8-543-1510	10	BB	19-22	15	67	31	8-500-1510

*Minimum Ultimate Load is 4 times the Working Load Limit.



Quality Control, Testing, and Detecting during manufacturing

YOKE runs a constant and strict production facility with quality control in every manufacturing stage from raw materials to the completed product. YOKE is an ISO 9001 certified company and has Type Approval by the major international authorities from SABS, ZU, ABS, API, and DNV. YOKE has achieved CNLA certification - Chinese National Laboratory Accreditation which ensures a quality research and development (R&D) department and unsurpassed product engineering.

Magnaflux Crack Detection :

All forged components, each individually magnaflux detected after heat treatment.

Proof Load Testing :

Chain and components are proof load tested at 2.5 times the Working Load Limits with resultant permanent deformation within 1%.

Dynamic Fatigue Testing :

Batch samples of chain and components are Dynamic Fatigue Tested at 1.5 times Working Load Limit for 20,000 cycles.

Ultimate Breaking Load Testing :

Batch samples are Break Load Tested in a static tensile testing machine to ultimate failure. The minimum ultimate force is equal to the Working Load Limit times the safety factor.

Spectrographic Analysis :

To assure of the proper metallurgy content of all raw materials.

Eddy Current Detection :

All load pins are 100% individually inspected after heat treatment.



Test certificate
Complied to EN10204



Feature & Advantage

360° rotation with 90° or 230° pivot
Small size, light weight
Lower total cost
Type approval
(CE, BG GS-OA)
Easy for using and handling

Construction & Mining
Material Handling
Maintenance Repair Operations
(MRO)
Mold & Die
Wind energy

Hoist Rings with Alloy Steel Washer - 360° rotation and 180° swivel, rated 100% at 90°
UNC Thread (8-204) - (ASME / ANSI B18.3.1M)

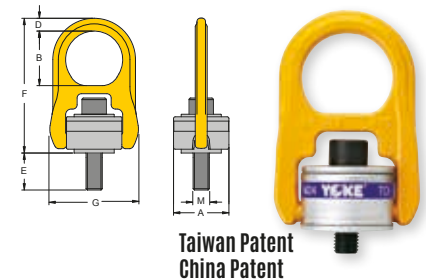

Code	Working Load Limit	Thread	Dimensions in.						Torque in.		Net Weight
	lbs*		TPI	A	B	D	E	F	G	ft. lbs	
	800	5/16 - 18UNC	1.57	1.61	0.35	0.71	4.02	2.56	7	0.9	
	1000	3/8 - 16UNC	1.57	1.61	0.35	0.71	4.02	2.56	12	0.9	
S	2500	1/2 - 13UNC	2.56	2.32	0.59	0.75	6.26	4.13	28	3.7	
	2500	1/2 - 13UNC	2.56	2.32	0.59	1.26	6.26	4.13	28	3.7	
S	4000	5/8 - 11UNC	2.56	2.32	0.59	0.74	6.26	4.13	60	4.0	
	4000	5/8 - 11UNC	2.56	2.32	0.59	1.75	6.26	4.13	60	4.0	
S	5000	3/4 - 10UNC	2.56	2.87	0.59	1.24	6.26	4.13	100	4.0	
	5000	3/4 - 10UNC	2.56	2.87	0.59	1.73	6.26	4.13	100	4.2	
S	7000	3/4 - 10UNC	3.35	2.87	0.59	0.87	6.26	5.28	100	8.8	
	7000	3/4 - 10UNC	3.35	2.87	0.87	1.87	8.03	5.28	100	9.5	
S	8000	7/8 - 9UNC	3.35	2.87	0.87	1.43	8.03	5.28	160	9.3	
	8000	7/8 - 9UNC	3.35	2.87	0.87	2.37	8.03	5.28	160	9.7	
S	10000	1 - 8UNC	3.35	2.87	0.87	1.36	8.03	5.28	230	9.5	
	10000	1 - 8UNC	3.35	2.87	0.87	2.36	8.03	5.28	230	10.1	
	15000	1 1/4 - 7UNC	3.95	3.15	1.00	2.25	8.58	6.30	470	14.5	
	24000	1 1/2 - 6UNC	4.72	4.29	1.38	2.17	12.09	8.66	800	35.2	
	30000	2 - 4.5UNC	4.72	4.29	1.38	3.01	12.09	8.66	1100	35.2	

* Design Factor 5:1 § Long Bolts are designed for soft metal work piece. ** Bolt in GEOMET® finished on request

Hoist Rings with Alloy Steel Washer - 360° rotation and 180° swivel, rated 100% at 90°
Metric Thread (8-203) - (ASME / ANSI B18.3.1M)

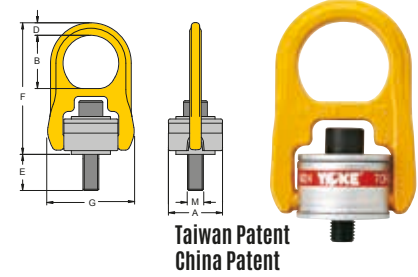

Code	Working Load Limit		Thread	Dimensions (mm)						Torque in.	Net Weight
	5 : 1	4 : 1		M	A	B	D	E	F		
8-203-004	0.40	0.50	M 8 x 1.25	40	41	9	17	102	65	10	0.4
8-203-005	0.45	0.55	M10 x 1.5	40	41	9	11	102	65	16	0.5
§ 8-203-005L	0.45	0.55	M10 x 1.5	40	41	9	26	102	65	16	0.5
8-203-010	1.05	1.30	M12 x 1.75	65	64	15	15	158	105	38	1.7
§ 8-203-010L	1.05	1.30	M12 x 1.75	65	64	15	30	158	105	38	1.7
8-203-019	1.90	2.40	M16 x 2	65	64	15	20	158	105	81	1.8
§ 8-203-019L	1.90	2.40	M16 x 2	65	64	15	35	158	105	81	1.8
8-203-021	2.15	2.70	M20 x 2.5	65	64	15	25	158	105	136	1.8
§ 8-203-021L	2.15	2.70	M20 x 2.5	65	64	15	45	158	105	136	1.9
8-203-030	3.00	3.75	M20 x 2.5	85	79	19	25	204	134	136	4.0
§ 8-203-030L	3.00	3.75	M20 x 2.5	85	79	19	45	204	134	136	5.2
8-203-042	4.20	5.25	M24 x 3	85	79	19	26	204	134	312	4.2
§ 8-203-042L	4.20	5.25	M24 x 3	85	79	19	56	204	134	312	4.3
8-203-070	7.00	8.75	M30 x 3.5	100	100	25	81	241	160	637	6.6
8-203-110	11.00	13.75	M36 x 4	120	111	30	76	286	194	1005	15.0
8-203-125	12.50	15.60	M42 x 4.5	120	111	30	65	286	220	1005	16.0
8-203-135	13.50	16.90	M48 x 5	120	111	30	70	286	220	1350	16.0
8-203-155	15.50	19.40	M56 x 5.5	138	109	34	79	308	241	1350	19.1
8-203-223	22.30	27.90	M64 x 6	138	100	38	98	312	241	2847	23.0

* Proof Load is 2.5 times the Working Load Limit on the 4:1 design factor. ** Bolt in GEOMET® finished on request § Long Bolts are designed for soft metal work piece.

Anchor Points

360° Rotation and 180° Swivel: Simultaneously allows lifting from any direction.
UNC Thread (8-232) - (ASME / ANSI B18.3.1M)

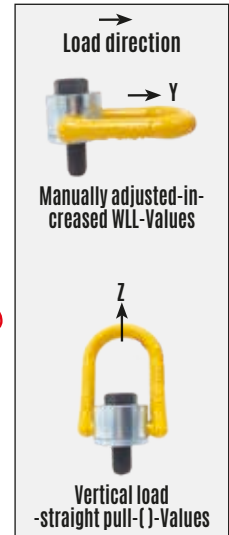
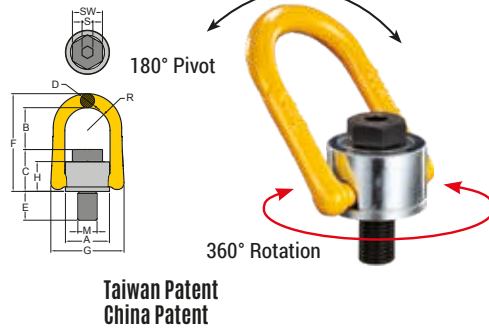

Code	Working Load Limit		Thread					Dimensions in.								Torque in.	Net Weight
	y	(z)	M	E	TPI	A	B	C	D	F	G	H	R	S	SW		
8-232-010	0.8	1.6	1/2	0.81	13 UNC	1.3	1.57	1.20	0.41	3.17	2.28	0.90	0.67	5/16	3/4	100	1.8
8-232-020	1.6	2.6	5/8	1.13	11 UNC	1.97	2.13	1.81	0.65	4.61	3.54	1.42	1.06	3/8	15/16	150	2.0
8-232-030	2.4	4.0	3/4	1.54	10 UNC	1.97	2.07	1.89	0.65	4.61	3.54	1.42	1.06	1/2	1 1/8	250	2.2
8-232-038	3.0	4.5	7/8	1.42	9 UNC	2.56	2.99	2.28	0.79	6.02	4.25	1.73	1.34	5/8	1 5/16	300	4.3
8-232-050	4.5	7.4	1	1.61	8 UNC	2.81	3.17	2.34	0.98	6.38	4.92	1.73	1.46	5/8	1 1/2	400	5.7
8-232-078	6.25	9.6	1 1/4	2.09	7 UNC	3.43	3.66	2.23	1.18	8.07	5.83	2.44	1.79	7/8	1 7/8	500	11.0
8-232-125	10.0	11.0	1 1/2	2.40	6 UNC	4.29	4.38	3.87	1.42	9.92	7.40	3.07	2.22	1	2 1/4	800	21.2
8-232-200	16.0	16.0	2	3.00	4.5 UNC	4.61	3.80	4.46	1.42	9.93	7.71	3.35	2.38	1 1/4	3	2000	25.6

* Proof Load is 2.5 times the Working Load Limit on the 5:1 design factor. * Bolt in GEOMET® finished on request

Also available in Metric

Lifting Points - Rotates 360° and swivels 90°
UNC Thread (8-212) - (ASME / ANSI B18.3.1M)

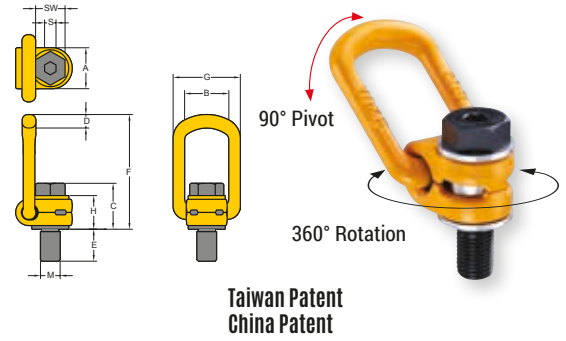

Code	Working Load Limit TONS*	Thread version			Dimensions in.										Torque in. Nm	Net Weight lbs.
		M	E	TPI	A	B	C	D	F	G	H	S	SW			
		in.	in.					in.								
8-212-010	1	1/2	0.75	13UNC	1.30	1.46	1.73	0.53	3.86	2.24	1.42	5/16	3/4	100	1.1	
8-212-015	1.5	5/8	0.94	11UNC	1.30	1.46	1.81	0.53	3.86	2.24	1.42	3/8	15/16	150	1.1	
8-212-020	2.5	3/4	1.10	10UNC	1.97	2.13	2.20	0.65	5.51	3.23	1.73	1/2	1 1/8	250	2.9	
8-212-025	2.5	7/8	1.10	9UNC	1.97	2.13	2.28	0.65	5.51	3.23	1.73	5/8	1 5/16	300	2.9	
8-212-040	4	1	1.61	8UNC	1.97	2.13	2.34	0.65	5.51	3.23	1.73	5/8	1 1/2	400	3.1	
8-212-050	5	1 1/4	1.61	7UNC	2.36	2.56	3.23	0.89	6.69	3.90	2.44	7/8	1 7/8	500	6.8	
8-212-080	8	1 1/2	2.25	6UNC	3.03	3.35	4.01	1.04	8.86	4.88	3.07	1	2 1/4	800	12.8	
8-212-150	15	1 3/4	2.63	5UNC	3.74	4.09	4.48	1.42	10.08	6.22	3.39	1	2 5/8	1500	24.0	
8-212-200	20	2	3.00	4.5UNC	3.74	4.09	4.76	1.42	10.20	6.22	3.54	1 1/4	3	2000	25.5	

* Design Factor 4:1 * Bolt in GEOMET® finished on request

Lifting Points - Rotates 360° and swivels 90°
Metric Thread (8-211) - (ASME / ANSI B18.3.1M)

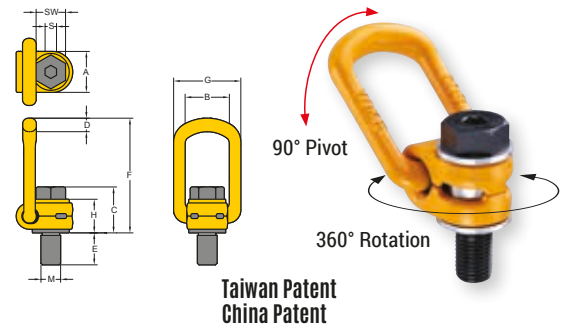

Code	Working Load Limit TONS*	Thread version			Dimensions										Torque in. Nm	Net Weight kg
		M	E	Pitch	A	B	C	D	F	G	H	S	SW			
		mm	mm	DIN13				mm								
8-211-003	0.3	M 8	11	1.25	30	35	35	10	85	55	29	6	13	30	0.2	
8-211-006	0.63	M 10	16	1.5	30	35	36	10	85	55	29	6	17	60	0.3	
8-211-010	1	M 12	18	1.75	33	37	44	14	98	57	36	8	19	100	0.5	
8-211-012	1.2	M 14	21	2	33	37	45	14	98	57	36	10	22	120	0.5	
8-211-015	1.5	M 16	24	2	33	37	46	14	98	57	36	10	24	150	0.5	
8-211-020	2	M 18	26	2	50	54	57	17	140	82	44	12	30	200	1.3	
8-211-025	2.5	M 20	30	2.5	50	54	57	17	140	82	44	12	30	250	1.3	
8-211-040	4	M 24	36	3	50	54	59	17	140	82	44	14	36	400	1.4	
8-211-042	4	M 27	38	3	60	65	79	23	170	99	62	17	41	400	2.8	
8-211-050	5	M 30	48	3.5	60	65	81	23	170	99	62	17	46	500	3.1	
8-211-070	7	M 36	54	4	60	65	88	23	178	99	65	22	55	700	3.3	
8-211-080	8	M 36	62	4	77	85	101	27	225	124	78	22	55	800	5.8	
8-211-100	10	M 42	72	4.5	77	85	104	27	225	124	78	24	65	1000	6.3	
8-211-150	15	M 42	63	4.5	95	104	112	36	256	158	86	24	65	1500	10.8	
8-211-200	20	M 48	72	5	95	104	120	36	259	158	90	27	75	2000	11.6	
8-211-220	22	M 56	84	5.5	95	104	128	36	259	158	90	27	89	2100	15.0	
8-211-225	22.5	M 64	100	6	113	104	133	36	259	158	90	32	95	2200	16.3	

* Design Factor 4:1 * Bolt in GEOMET® finished on request

Screw Pin Shackle



Dimension in.	Working Load Limit TON*	Stock No.			Weight / each lbs.	Dimensions in.													Tolerance +/-	
		G-209	S-209	G-2090C		A	B	C	D	E	F	G	H	L	M	P	C	A		
3/16	1/3	1018357	-	-	.06	.38	.25	.88	.19	.60	.56	.98	1.47	.16	1.14	.19	.06	.06		
1/4	1/2	1018375	1018384	-	.10	.47	.31	1.13	.25	.78	.61	1.28	1.84	.19	1.43	.25	.06	.06		
5/16	3/4	1018393	1018400	-	.18	.53	.38	1.22	.31	.84	.75	1.47	2.09	.22	1.71	.31	.06	.06		
3/8	1	1018419	1018428	-	.31	.66	.44	1.44	.38	1.03	.91	1.78	2.49	.25	2.02	.38	.13	.06		
7/16	1-1/2	1018437	1018446	-	.38	.75	.50	1.69	.44	1.16	1.06	2.03	2.91	.31	2.37	.44	.13	.06		
1/2	2	1018455	1018464	-	.72	.81	.63	1.88	.50	1.31	1.19	2.31	3.28	.38	2.69	.50	.13	.06		
5/8	3-1/4	1018473	1018482	1262219	1.37	1.06	.75	2.38	.63	1.69	1.50	2.94	4.19	.44	3.34	.69	.13	.06		
3/4	4-3/4	1018491	1018507	1262228	2.35	1.25	.88	2.81	.75	2.00	1.81	3.50	4.97	.50	3.97	.81	.25	.06		
7/8	6-1/2	1018516	1018525	1262237	3.62	1.44	1.00	3.31	.88	2.28	2.09	4.03	5.83	.50	4.50	.97	.25	.06		
1	8-1/2	1018534	1018543	1262246	5.03	1.69	1.13	3.75	1.00	2.69	2.38	4.69	6.56	.56	5.13	1.06	.25	.06		
1-1/8	9-1/2	1018552	1018561	1262255	7.41	1.81	1.25	4.25	1.16	2.91	2.69	5.16	7.47	.63	5.71	1.25	.25	.06		
1-1/4	12	1018570	1018589	1262264	9.50	2.03	1.38	4.69	1.29	3.25	3.00	5.75	8.25	.69	6.25	1.38	.25	.06		
1-3/8	13-1/2	1018598	1018605	1262273	13.53	2.25	1.50	5.25	1.42	3.63	3.31	6.38	9.16	.75	6.83	1.50	.25	.13		
1-1/2	17	1018614	1018623	1262282	17.20	2.38	1.63	5.75	1.54	3.88	3.63	6.88	10.00	.81	7.33	1.62	.25	.13		
1-3/4	25	1018632	1018641	1262291	27.78	2.88	2.00	7.00	1.84	5.00	4.19	8.86	12.34	1.00	9.06	2.25	.25	.13		
2	35	1018650	1018669	-	45.00	3.25	2.25	7.75	2.08	5.75	4.81	9.97	13.68	1.22	10.35	2.40	.25	.13		
2-1/2	55	1018678	1018687	-	85.75	4.13	2.75	10.50	2.71	7.25	5.69	12.87	17.84	1.38	13.00	3.13	.25	.25		

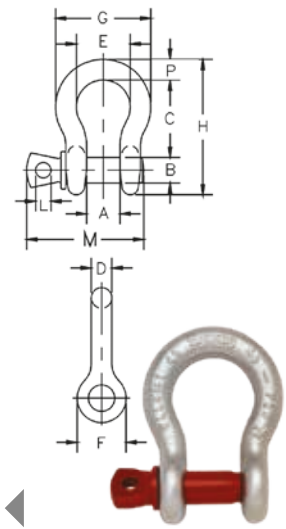

Bolt Pin Shackle



Dimension in.	Working Load Limit TON*	Stock No.			Weight / each lbs.	Dimensions in.													Tolerance +/-	
		G-2130	S-2130	G-21300C		A	B	C	D	E	F	H	L	M	N	C	A			
3/16	1/3 ‡	1019464	-	-	.06	.38	.25	.88	.19	.60	.56	1.47	.98	1.29	.19	.06	.06			
1/4	1/2	1019466	-	-	.11	.47	.31	1.13	.25	.78	.61	1.84	1.28	1.56	.25	.06	.06			
5/16	3/4	1019468	-	-	.22	.53	.38	1.22	.31	.84	.75	2.09	1.47	1.82	.31	.06	.06			
3/8	1	1019470	-	-	.33	.66	.44	1.44	.38	1.03	.91	2.49	1.78	2.17	.38	.13	.06			
7/16	1-1/2	1019471	-	-	.49	.75	.50	1.69	.44	1.16	1.06	2.91	2.03	2.51	.44	.13	.06			
1/2	2	1019472	1019481	-	.79	.81	.64	1.88	.50	1.31	1.19	3.28	2.31	2.80	.50	.13	.06			
5/8	3-1/4	1019490	1019506	1262013	1.68	1.06	.77	2.38	.63	1.69	1.50	4.19	2.94	3.56	.69	.13	.06			
3/4	4-3/4	1019515	1019524	1262022	2.72	1.25	.89	2.81	.75	2.00	1.81	4.97	3.50	4.15	.81	.25	.06			
7/8	6-1/2	1019533	1019542	1262031	3.95	1.44	1.02	3.31	.88	2.28	2.09	5.83	4.03	4.82	.97	.25	.06			
1	8-1/2	1019551	1019560	1262040	5.66	1.69	1.15	3.75	1.00	2.69	2.38	6.56	4.69	5.39	1.06	.25	.06			
1-1/8	9-1/2	1019579	1019588	1262059	8.27	1.81	1.25	4.25	1.13	2.91	2.69	7.47	5.16	5.90	1.25	.25	.06			
1-1/4	12	1019597	1019604	1262068	11.71	2.03	1.40	4.69	1.29	3.25	3.00	8.25	5.75	6.69	1.38	.25	.06			
1-3/8	13-1/2	1019613	1019622	1262077	15.83	2.25	1.53	5.25	1.42	3.63	3.31	9.16	6.38	7.21	1.50	.25	.13			
1-1/2	17	1019631	1019640	1262086	19.00	2.38	1.66	5.75	1.53	3.88	3.63	10.00	6.88	7.73	1.62	.25	.13			
1-3/4	25	1019659	1019668	1262095	33.91	2.88	2.04	7.00	1.84	5.00	4.19	12.34	8.80	9.68	2.25	.25	.13			
2	35	1019677	1019686	-	52.25	3.25	2.30	7.75	2.08	5.75	4.81	13.68	10.15	10.81	2.40	.25	.13			
2-1/2	55	1019695	1019702	-	98.25	4.13	2.80	10.50	2.71	7.25	5.69	17.90	12.75	13.58	3.13	.25	.25			
3	† 85	1019711	-	-	154.00	5.00	3.30	13.00	3.12	7.88	6.50	21.50	14.62	15.13	3.62	.25	.25			
3-1/2	† 120 ‡	1019739	-	-	265.00	5.25	3.76	14.63	3.62	9.00	8.00	24.88	17.02	17.00	4.38	.25	.25			
4	† 150 ‡	1019757	-	-	338.00	5.50	4.26	14.50	4.00	10.00	9.00	25.68	18.00	17.75	4.56	.25	.25			

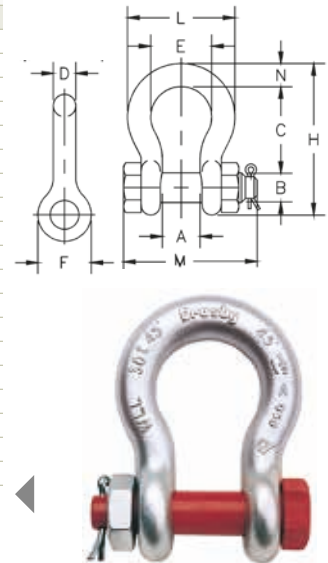

* NOTE: Maximum Proof Load is 2.0 times the Working Load Limit. Minimum Ultimate Strength is 6 times the Working Load Limit. † Individually Proof Tested with certification. ‡ Furnished in Anchor style only and furnished with Round Head Bolts with welded handles.

Wedge Sockets

Wire Rope Diameter		S-421T Stock No.	API 2C S-421T Stock No.	S-421TB Stock No.	API 2C S-421TB Stock No.	Weight / each (lbs.)	Wedge Only	Weight / each (lbs.)	API 2C Bolt, Nut & Cotter Assy	Standard Bolt, Nut & Cotter Assy	Weight / each (lbs.)
(in.)	(mm)										
3/8	9-10	1035000	1035005	1035203	1035205	3.18	1035555	.50	1092230	2038971	.38
1/2	11-13	1035009	1035014	1035212	1035214	6.15	1035564	1.05	1092248	2038974	.69
5/8	14-16	1035018	1035023	1035221	1035223	9.70	1035573	1.79	1092257	2038976	1.15
3/4	18-19	1035027	1035032	1035230	1035232	14.50	1035582	2.60	1092293	2038978	1.91
7/8	20-22	1035036	1035041	1035249	1035251	21.50	1035591	4.00	1092319	2038980	3.23
1	24-26	1035045	1035050	1035258	1035260	30.75	1035600	5.37	1092337	2038982	5.40
1-1/8	28	1035054	1035059	1035267	1035269	45.30	1035609	7.30	1092364	2038984	7.50
1-1/4	30-32	1035063	1035068	1035276	1035278	64.90	1035618	10.60	1092375	2038971	10.34

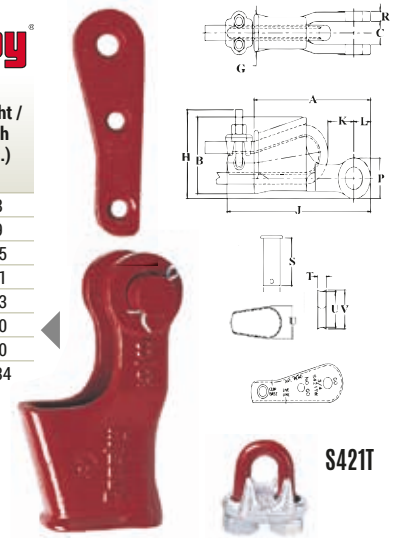

Wire Rope Diameter		S-421T Stock No.	API 2C S-421T Stock No.	S-421TB Stock No.	API 2C S-421TB Stock No.	Dimensions in.														
(in.)	(mm)					A	B	C +/- .09	D	G	H	J*	K*	L	P	R	S	T	U	V
3/8	9-10	1035000	1035005	1035203	1035205	5.69	2.72	.81	.81	1.38	3.06	7.80	1.88	.88	1.56	.44	2.13	.44	1.25	1.38
1/2	11-13	1035009	1035014	1035212	1035214	6.88	3.47	1.00	1.00	1.62	3.76	8.91	1.26	1.06	1.94	.50	2.56	.53	1.75	1.88
5/8	14-16	1035018	1035023	1035221	1035223	8.25	4.30	1.25	1.19	2.12	4.47	10.75	1.99	1.22	2.25	.56	3.25	.69	2.00	2.19
3/4	18-19	1035027	1035032	1035230	1035232	9.88	5.12	1.50	1.38	2.44	5.28	12.36	2.41	1.40	2.63	.66	3.63	.78	2.34	2.56
7/8	20-22	1035036	1035041	1035249	1035251	11.25	5.85	1.75	1.63	2.69	6.16	14.37	2.48	1.67	3.13	.75	4.31	.88	2.69	2.94
1	24-26	1035045	1035050	1035258	1035260	12.81	6.32	2.00	2.00	2.94	6.96	16.29	3.04	2.00	3.75	.88	4.70	1.03	2.88	3.28
1-1/8	28	1035054	1035059	1035267	1035269	14.38	6.92	2.25	2.25	3.31	7.62	18.34	2.56	2.25	4.25	1.00	5.44	1.10	3.25	3.56
1-1/4	30-32	1035063	1035068	1035276	1035268	16.34	8.73	2.62	2.50	3.56	9.39	20.48	2.94	2.34	4.50	1.06	6.13	1.19	4.62	4.94

* Nominal NOTE: For intermediate wire rope sizes, use next larger size socket. The S-423T Super TERMINATOR wedge is designed to be assembled only into the Crosby S-421T TERMINATOR socket body. IMPORTANT: The S-423TW for sizes 5/8" through 1-1/8" (14mm through 28mm) will fit respective size standard Crosby S-421T basket. The 1-1/4" (30-32mm) S-423TW will only fit the Crosby S-421T 1-1/4" basket marked with TERMINATOR.

Forged Cable Clamps



Wire Rope Diameter		G-450 Stock No.	Std Package Qty.	Weight Per 100 (lbs.)	Dimensions in.									
(in.)	(mm)				A	B	C	D	E	F	G	H		
1/8	3-4*	1010015	100	6	.22	.72	.44	.47	.37	.38	.81	.99		
3/16*	5*	1010033	100	10	.25	.97	.56	.59	.50	.44	.94	1.18		
1/4	6-7	1010051	100	19	.31	1.03	.50	.75	.66	.56	1.19	1.43		
5/16	8	1010079	100	28	.38	1.38	.75	.88	.73	.69	1.31	1.66		
3/8	9-10	1010097	100	48	.44	1.50	.75	1.00	.91	.75	1.63	1.94		
7/16	11	1010113	50	78	.50	1.88	1.00	1.19	1.13	.88	1.91	2.28		
1/2	12-13	1010131	50	80	.50	1.88	1.00	1.19	1.13	.88	1.91	2.28		
9/16	14-15	1010159	50	109	.56	2.25	1.25	1.31	1.34	.94	2.06	2.50		
5/8	16	1010177	50	110	.56	2.25	1.25	1.31	1.34	.94	2.06	2.50		
3/4	18-20	1010195	25	142	.62	2.75	1.44	1.50	1.39	1.06	2.25	2.84		
7/8	22	1010211	25	212	.75	3.12	1.62	1.75	1.58	1.25	2.44	3.16		
1	24-26	1010239	10	252	.75	3.50	1.81	1.88	1.77	1.25	2.63	3.47		
1-1/8	28-30	1010257	10	283	.75	3.88	2.00	2.00	1.91	1.25	2.81	3.59		
1-1/4	32-34	1010275	10	438	.88	4.44	2.22	2.34	2.17	1.44	3.13	4.13		
1-3/8	36	1010293	10	442	.88	4.44	2.22	2.34	2.31	1.44	3.13	4.19		
1-1/2	38	1010319	10	544	.88	4.94	2.38	2.59	2.44	1.44	3.41	4.44		
1-5/8	41-42	1010337	Bulk	704	1.00	5.31	2.62	2.75	2.66	1.63	3.63	4.75		
1-3/4	44-46	1010355	Bulk	934	1.13	5.75	2.75	3.06	2.92	1.81	3.81	5.24		
2	48-52	1010373	Bulk	1300	1.25	6.44	3.00	3.38	3.03	2.00	4.44	5.88		
2-1/4	56-58	1010391	Bulk	1600	1.25	7.13	3.19	3.88	3.19	2.00	4.56	6.38		
2-1/2	62-65	1010417	Bulk	1900	1.25	7.69	3.44	4.13	3.69	2.00	4.69	6.63		
** 2-3/4 **	68-72	1010435	Bulk	2300	1.25	8.31	3.56	4.38	4.88	2.00	5.00	6.88		
3	75-78	1010453	Bulk	3100	1.50	9.19	3.88	4.75	4.44	2.38	5.31	7.61		
** 3-1/2 **	85-90	1010426	Bulk	4000	1.50	10.75	4.50	5.50	6.00	2.38	6.19	8.38		

* Electro-plated U-Bolt and Nuts. ** 2-3/4" and 3-1/2" base is made of cast steel.

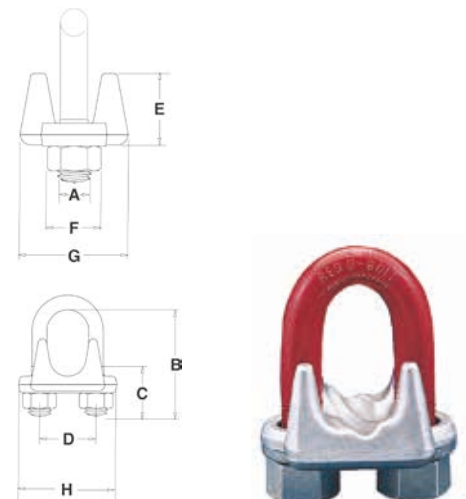

Eye Hook W/Latch



Working Load Limit TON*		Hook ID Code	Eye Hook Stock No.					Weight / each (lbs.)	Replacement Latch Kits		
Carbon	Alloy		Carbon S-320C S-320CN S.C.	Carbon L-320C L-320CN S.C.	Carbon G-320CN Galv.	Alloy S-320A S-320AN S.C.	Alloy L-320A L-320AN S.C.		S-4320 Stock No.	PL Stock No.	SS-4055 Stock No.
3/4	1	†D	1022200	1022205	1022208	1022375	1022380	.61	1096325	-	-
1	1-1/2	†F	1022211	1022216	1022219	1022386	1022391	.89	1096374	-	-
1-1/2	2	†G	1022222	1022227	1022230	1022397	1022402	1.44	1096421	-	-
2	3	†H	1022233	1022238	1022241	1022406	1022413	2.07	1096468	-	-
3	5	†I	1022244	1022246	1022249	1022419	1022424	4.30	1096515	1092000	-
5	7	†J	1022255	1022260	1022262	1022430	1022435	8.30	1096562	1092001	-
7-1/2	11	†K	1022264	1022271	1022274	1022441	1022446	15.00	1096609	1092002	-
10	15	†L	1022277	1022282	1022285	1022452	1022457	20.77	1096657	1092003	-
15	22	†N	1022288	1022293	1022296	1022465	1022468	39.50	1096704	1092004	-
20	30	O	1023289	1023302	-	1023546	1022479	60.00	-	1093716	1090161
25	37	P	1023305	-	-	1023564	-	105.00	-	1093717	1090189
30	45	S	1023323	-	-	1023582	-	148.00	-	1093718	1090189
40	60	T	1023341	-	-	1023608	-	228.00	-	1093719	1090205



*Eye Hooks (3/4 TC - 22TA), Proof load is 2 times Working Load Limit. Eye Hooks (20 TC - 60TA). All carbon hooks-average straightening load (ultimate load) is 5 times Working Load Limit. Alloy eye hooks 1 ton through 22 ton-average straightening load (ultimate load) is 5 times Working Load Limit. Alloy eye hooks 30 tons through 60 tons-average straightening load (ultimate load) is 4.5 times Working Load Limit. † New 320N style hook.

Swivel Eye Hook W/Latch



Working Load Limit TON*		L-322 CN Stock No.	L-322 AN Stock No.	Weight / each (lbs.)	Dimensions in.													Replacement Latch Stock No.		
Carbon	Alloy				A	B	C	D	F	G	H	J	K	L	M	O†	R		S	AA**
3/4	1	1048603	1048807	.75	2.00	.82	1.25	2.86	1.25	.73	.81	.93	.63	5.66	.63	.89	4.55	.38	1.50	1096325
1	1-1/2	1048612	1048816	1.25	2.50	1.31	1.50	3.15	1.38	.84	.94	.97	.71	6.71	.71	.91	5.37	.50	2.00	1096374
1-1/2	2	1048621	1048825	2.25	3.00	1.50	1.75	3.59	1.50	1.00	1.16	1.06	.88	7.75	.88	1.00	6.12	.63	2.00	1096421
2	3	1048630	1048834	2.30	3.00	1.50	1.75	4.00	1.62	1.13	1.31	1.19	.94	8.25	.94	1.09	6.50	.63	2.00	1096468
3	5	1048639	1048840	4.96	3.50	1.64	2.00	4.84	2.00	1.44	1.63	1.50	1.31	9.69	1.13	1.36	7.50	.75	2.50	1096515
5	7	1048648	1048859	10.29	4.56	2.29	2.50	6.28	2.50	1.81	2.06	1.78	1.66	12.47	1.44	1.61	9.63	1.00	3.00	1096562
7-1/2	11	1048657	1048868	19.40	5.00	2.44	2.75	7.54	3.00	2.25	2.63	2.41	1.88	14.75	1.63	2.08	11.37	1.13	4.00	1096609
10	15	1048666	1048880	23.25	5.62	2.48	3.12	8.34	3.25	2.59	2.94	2.62	2.19	16.40	1.94	2.27	12.25	1.25	4.00	1096657
15	22	1048675	1048889	47.00	7.10	3.76	4.10	10.34	4.25	3.00	3.50	3.41	2.69	21.34	2.38	3.02	16.71	1.50	5.00	1096704
-	30	-	-	70.50	7.10	3.76	4.10	13.62	5.00	3.61	4.63	4.00	3.00	23.25	3.00	3.25	18.01	1.50	6.50	1093716

* Carbon swivel hooks .75tc-15tc: proof load is 2 times working load limit. Designed with a 5 to 1 safety factor. Alloy swivel hooks 1.25ta-31.5ta : proof load is 2.5 times working load limit. Designed with a 4 to 1 safety factor. Alloy swivel hook 30ta: proof load is 2 times working load limit. Designed with a 4 to 1 design factor. ** Deformation Indicators † Dimensions for hooks 3/4t carbon thru 22t alloy are for S-4320 latch kits. Dimensions for hooks 31.5t alloy are for PL latch kit.

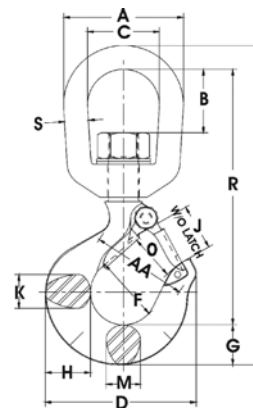

Winchline Tail Chain



Wire Rope Diameter (in.)*	L-180 Stock No.	Working Load Limit (lbs)†	Length (in.)	No. of Links	Weight / Each (lbs)
3/4 - 7/8	1091511	34200	24	8	18.2
1 - 1-1/8	1091516	47700	18	5	21.2
1 - 1-1/8	1091525	47700	24	7	23.3
1-1/4	1091532	72300	24	5	40.0

Not intended for overhead lifting

* Recommended for IPS or XIP (EIP), RRL, FG or IWRC wire rope. † Ultimate Load is 3.5 times the Working Load Limit.



Self Locking Eye Hook



Chain Size		Frame Code	Grade 100 Alloy Chain Working Load Limit (lbs)* 4:1	Working Load Limit (lbs) 5:1	S-1316 Stock No.	Weight / Each (lbs)	Dimensions in.									
(in.)	(mm)						A	C	D	E	F	H	J	L	AA**	
-	6	D	3200	2560	1022896	.85	.78	3.95	.79	2.60	.67	.31	.63	1.14	1.50	
1/4-5/16	7-8	G	5700	4560	1022914	1.80	1.08	5.31	1.10	3.50	.87	.39	.81	1.48	2.00	
3/8	10	H	8800	7040	1022923	3.40	1.30	6.57	1.17	4.39	1.10	.51	.94	1.83	2.50	
1/2	13	I	15000	12000	1022932	6.00	1.65	8.23	1.67	5.45	1.26	.67	1.16	2.22	3.00	
5/8	16	J	22600	18000	1022941	15.1	2.20	10.06	2.04	6.56	1.50	.87	1.50	2.65	3.50	
3/4	18-20	-	35300	28240	1022942	19.0	2.60	10.77	2.22	7.76	2.01	.87	2.03	3.52	5.00	
7/8	22	-	42700	34160	1022943	28.0	2.87	12.49	2.45	8.75	2.27	.98	2.20	3.83	6.00	
1	26	-	59700	47,760	1022944	49.5	3.15	14.60	3.21	9.87	2.46	1.26	2.68	4.09	6.50	

* Minimum Ultimate Load is 4 times the Working Load Limit. ** Deformation Indicators.

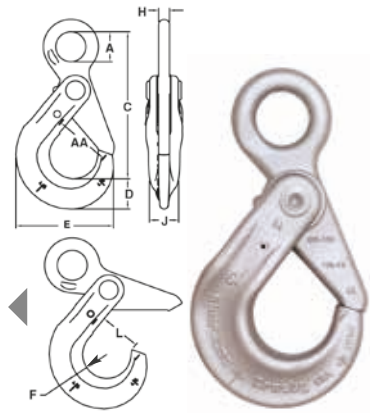

SORTING HOOK



Working Load Limit at Top of Hook TONNES*	Working Load Limit at Top of Hook TON*	A-378 Stock No.	Style	Weight / Each (lbs)	Dimensions in.			
					I.D. of Eye	Overall Length	Opening at top of Hook	Radius at bottom of Hook
2	7-1/2	1028024	No Handle	6.42	1.38	9.69	2.81	.625
2	7-1/2	1028033	With Handle	6.42	1.38	9.69	2.81	.625

* Minimum Ultimate Load is 4 times the Working Load Limit.

BEN-MOR Hooked on Service



Web Sling Inspection Criteria

It is important to inspect your web slings after purchase.

Types of inspection

Initial Inspection - Before any new or repaired web sling is placed in service, it shall be inspected by a designated competent person to ensure that the correct web sling is being used, as well as to determine that the web sling meets the applicable requirements.

Frequent Inspection - This inspection should be conducted by the person handling the sling each time the sling is used.

Periodic Inspection - This inspection shall be conducted by the designated staff. Frequency of inspection should be based on frequency of web sling use, severity of service conditions and experience gained on the service life of web slings used in similar applications. Inspections should be conducted at least annually.

Often riggers confuse a cut sling for a broken sling. View the pictures below to see the difference. The cut sling has come into contact with something sharp that has sliced the sling in half. (You can tell by the clean edge). The broken sling has been pulled to destruction on our test bed. The ends are frayed and melted from heat friction.



Cut sling



Broken sling



Cut Eye



Snag



Illegible Tag

Remove the sling from service if any of the following is visible :

- If sling rated capacity or sling material identification is missing or not legible
- Acid or alkaline burns
- Melting, charring or weld spatters on any part of the web sling
- Holes, tears, cuts, snags or embedded particles, that exposes core yarns
- Broken or worn stitching in load bearing splices
- Excessive abrasive wear
- Knots in any part of the web sling
- Excessive pitting, or corrosion, or cracked, or distorted, or broken fittings
- Any other visible damage that causes doubt as to the strength of the sling

Inspection Records

Written inspection records, utilizing the identification for each sling as established by the user, should be kept on file for all web slings. These records should show a description of the sling and its condition on each periodic inspection.

Repair of Web Slings

Web slings with structural damage shall never be repaired. Web slings utilizing hardware may be rewbedded. The fittings must be visually inspected and proof tested before they can be used.



WARNING!

These pages contain important safety information about the use of synthetic slings. However, it DOES NOT contain all the information you need to know about handling, lifting and manipulating materials and loads safely. Sling use is only one part of a lifting system and it is your responsibility to consider all risk factors prior to using any rigging device or product. Failure to do this may result in severe INJURY or DEATH due to sling failure and/or loss of load.

Read and follow all use and safety information provided with sling. Failure to do so may result in severe INJURY or DEATH due to sling failure and/or loss of load.

The following six points briefly summarize some important safety issues :

1. All users must be trained in sling selection, use and inspection, cautions to take, environmental effects and rigging practices.
2. Inspect slings for damage regularly, if the sling is damaged, remove it from service.
3. Protect slings from damage. ALWAYS protect slings in contact with edges, corners, protrusions, or abrasive surfaces with materials of sufficient strength, thickness and construction to prevent damage.
4. Do not exceed a sling's rated capacity. Always consider the effect of sling angle and tension on the sling's rated capacity.
5. Do not stand on, under or near a load with the sling under tension. All the staff should be alert to danger of falling and/or uncontrolled load, sling tension and the potential for snagging.
6. Maintain and store slings properly. Slings should be protected from mechanical, chemical and environmental damage.

1. ALL SLING USERS MUST BE TRAINED AND KNOWLEDGEABLE

All sling users must be trained on the proper use of slings.

It is important that all sling users be trained and knowledgeable about the safe and proper use and application of slings and be thoroughly familiar with the manufacturer's recommendations and safety materials provided with each product. In addition, all sling users need to be aware of their responsibilities as outlined in all applicable standards and regulations. (Please see The American Society of Mechanical Engineers; Safety standards for slings (ASME B30.9)

If you are unsure whether you are properly knowledgeable or trained, or if you are unsure of what the standards and regulations require of you, ask your employer for information and/or training-DO NOT use slings until you are absolutely sure of what you are doing. Remember, when it comes to using slings, lack of skill, knowledge and care can result in severe INJURY or DEATH to you and others.

2. SLINGS MUST BE REGULARLY AND PROPERLY INSPECTED

Even seemingly «minor» damage to a sling can significantly reduce its capacity to hold or lift objects and increases the risk that the sling will fail during use. Therefore, it is very important that slings are regularly and properly inspected. In reality, there simply is no such thing as «minor» damage. If you are not sure whether a sling is damaged, DO NOT USE IT!

Generally, damage to slings can be detected visually. In some instances, internal damage can occur and not be visible. To detect possible damage, you should perform a visual inspection of the entire sling and also feel along its entire length, as some damage may be felt more than seen. You should look and feel for any of the types of conditions listed in Table 1.

A three-stage procedure is recommended to help ensure that slings are inspected with appropriate frequency.

Initial Inspection - Whenever a sling is initially received, it must be inspected by a designated person to help ensure that the correct sling has been received and is undamaged, and that the sling meets applicable requirements for its intended use.

Frequent Inspection - The entire sling must be inspected before each shift or day in normal service and before each use in severe service applications.

Periodic Inspection - Every sling must be inspected «periodically» by a qualified and designated person. In order to validate the frequent level of inspection, the periodic inspection should be performed by someone other than the individual(s) who most commonly performs the frequent inspection. The frequency of periodic inspections is based on the sling's actual or expected frequency of use, severity of service conditions, the nature of the work performed with the sling and experience gained during the inspection of other slings used in similar circumstances. General guidelines for the frequency of periodic inspections are: Normal service is yearly, Severe service is monthly to quarterly, and Special service is as recommended by qualified person. Periodic inspections must not exceed one year.

TABLE 1 : Sling removal criteria

The entire sling must be inspected regularly and it shall be removed from service if ANY of the following are detected:

- If sling identification tag is missing or not readable.
- Holes, tears, cuts, embedded materials, excessive abrasive wear, or snags that expose the core yarn of the sling.
- Broken or damaged core yarn.
- Knots in any part of the sling.
- Acid or alkaline burns on the sling.
- Melting, charring or weld spatter of any part of the sling.
- Distortion, excessive pitting, corrosion or other damage to fitting(s).
- Broken or worn stitching.
- Excessive, abrasive wear or crushed webbing.
- Signs of ultraviolet (UV) light degradation.
- If provided, exposed red core yarn. However, if damage is present and red yarns are not exposed DO NOT USE the sling.
- Any conditions which cause doubt as to the strength of the sling.

3. SLINGS MUST BE ADEQUATELY PROTECTED FROM DAMAGE

You should always avoid any action that causes the types of damage identified in the previous section, including (but not limited to) :

- Dropping or dragging slings on the ground, floor or over abrasive surfaces.
- Pulling slings from under loads when the load is resting on the sling; place blocks under the load if feasible.
- Shortening or adjusting sling using methods not approved by the sling manufacturer or qualified person.
- Twisting, kinking, or knotting the sling.
- Exposing slings to damaging acids or alkalis.
- Exposing slings to sources of heat damage or weld splatter.
- Using slings or allowing exposure to temperatures above the recommended temperatures listed on slings warning tags.
- «Tip loading» a sling on a hook instead of centering it in the base or «bowl» of the hook.
- Using hooks, shackles or other hardware that have edges or surfaces that could damage the sling.
- Running/driving over slings with a vehicle or other equipment.
- Synthetic slings are affected by some chemicals ranging from little to total degradation. Time, temperature and concentration factors affect the degradation. For specific applications, consult the manufacturer.

Synthetic slings can be damaged, abraded or cut by tension and compression between the sling, the connection points and the cargo develops. Surfaces in contact with the sling do not have to be very abrasive or have «razor» sharp edges in order to create the conditions for sling failure. Therefore, slings must ALWAYS be protected from being cut or damaged by corners, protrusions, or from contact with edges that are not smooth or well-rounded with materials sufficient for the intended purpose.

There are many ways to protect slings from such damages. A qualified person might select and use appropriately engineered protectors/softeners-commercially available products (e.g., sleeves, wear pads, corner protectors, etc.) specifically designed to protect slings from damage. A qualified person might also design and construct their own methods of protection as long as the sling is adequately protected and/or kept off of the damaging edge surface.

4. ALWAYS USE SLINGS PROPERLY

- When lifting loads, a trained, qualified and knowledgeable user must take into consideration the factors and issues addressed into these recommendations, as well as considering any other relevant factors not addressed herein. Among the factors related specifically to slings, users must perform several activities, including (but not limited to) those discussed in the following subsections.
- Determine the weight of the load and make sure it does not exceed the sling's rated capacity or the capacity of any of the components of the rigging system. Users must also determine the load's center of gravity (CG) to make sure the rigging system used will be able to retain and control the load once lifted.
- Select a sling having suitable characteristics for the type, size and weight of the load, the type of hitch and the environment. The sling must be securely attached to the load and rigged in a manner to provide load control to prevent slipping, sliding and/or loss of the load. A trained, qualified and knowledgeable user must determine the most appropriate method of rigging to help ensure a safe lift and control of the load.
- Avoid accelerating or decelerating the load too quickly (i.e. «shock loading»). Do not use slings to pull on stuck or snagged objects and do not use slings for towing purposes. A sling should only be used for lifting loads.

Categories	Issues/ Factors to Consider		
Environment	Wind Weather Visibility	Environmental temperature Object temperature Chemical conditions & Exposure	Ground stability Underground installations
Load	Weight Dimensions Center of Gravity	Attachment point integrity Susceptibility to crushing/ compression Loose parts that could fall from load	Combination loads Damaging surfaces / edges Structural stability (Bend / flex)
Equipment/ Lift	Single/ Multiple Cranes / Hoists Maximum / planned operating radius Allowable load Ratio of lift to allowable load	Clearance to surrounding facilities Power lines and other environmental hazards Clearance between boom & lift Emergency/ contingency set down area	Equipment inspection Ensure a clear load path
Rigging	Sling selection Load control Lift point (over CG) Positive sling-to-load engagement	Coefficient of friction: sling to load Appropriate hitch for (CG and load control) Load is free to move and is not snagged Coordination of multiple slings	Suitable wear protection Sling capacity is adequate for angle and tension
Staff	Area clear of unnecessary staff Staff are trained and qualified	Signals: Visual, audible, electronic, etc. Staff away from load and other dangers	Pre-lift plan and meeting Tag lines / spotter requirements



5. MAKE SURE THE STAFF IS CLEAR OF LOADS AND ALERT TO RISKS

Even if the factors/issues discussed into these pages are taken into consideration, things can still go wrong.

Therefore, all the staff must stand clear of the lifted loads and never be under, on or near suspended loads.

When using slings, no part of the body should be placed between the sling and load, or between the sling and lifting hook. In addition, the staff must be alert to the potential for the sling to become snagged during lifting, never use a sling to pull on objects in a snagged or constrained condition.

6. PROPERLY STORE AND MAINTAIN SLINGS

In order to prevent damage to slings when not in use, you should store slings in a cool, dry and dark location. Slings should be stored in an area free from environmental or mechanical sources of damage, such as: weld splatter, splinters from grinding or machining, heat sources, chemical exposure, etc. Also, keep slings clean and free of dirt, grime and foreign materials.

If slings are cleaned, use only mild soap and water. Rinse slings thoroughly and allow to dry completely before placing the slings back into storage or use.

Do not machine wash slings. Machine washing results in significant loss of sling strength.

Where to Find Additional Information

This bulletin does not provide you with all the information you need to know in order to be considered trained and knowledgeable about rigging and lifting loads, but it does provide important information about the use of slings within a rigging system. If you need more information about slings and rigging practices or your responsibilities according to regulations and standards, talk to your employer. You and your employer can consult a number of sources of information to help ensure that you are properly trained and knowledgeable when using slings, including (but not limited to):

- WSTDA-WS-1 – Recommended Standard Specification for Synthetic Slings
- ASME B30.9 – Synthetic Webbing Slings: Selections, use and maintenance
- OSHA 29 CFR 1910.184 – Slings
- OSHA Guidance on safe sling use
- Manufacturer’s Catalogue, manual, website, bulletins, rigging handbooks etc.
- Formal training provided by manufacturers or other outside entities.



RFID

Eliminate Paperwork... Empower Field Staff

Easy-Track delivers innovative solutions that streamline any inspection and maintenance process. Mobile computing, Radio Frequency (RFID) tagging are internet applications which you, your contractors, and your customers enhanced accuracy and operational efficiency, not to mention eliminating most of the paperwork.

Easy-Track utilizes durable RFID chips for fast and accurate identification, handheld computers capture inspections and maintenance operations, eliminating manual data entry. Capture equipment entering in and out of service as well as location transfers. All data is synchronized back to the online database and automatically disseminated to other parties.

Flexible

Easy-Track tracks any asset: tailor category and item specific attributes, inspection forms, test forms, material certs and other documentation. Initiate items in the shop or the field. This is made simple with prefilled templates and drop down menus for any asset detail you need to track.

Asset ID	Customer Name	Make	Model	Location	Last Test Date
123456789	ABC COMPANY	JOHN DEERE	855G	12345	1/1/2010
987654321	DEF COMPANY	CATERPILLAR	980	67890	2/1/2010
567890123	GHI COMPANY	JOHN DEERE	855G	12345	1/1/2010
456789012	JKL COMPANY	CATERPILLAR	980	67890	2/1/2010
345678901	MNO COMPANY	JOHN DEERE	855G	12345	1/1/2010
234567890	PQR COMPANY	CATERPILLAR	980	67890	2/1/2010
123456789	STU COMPANY	JOHN DEERE	855G	12345	1/1/2010
012345678	VWX COMPANY	CATERPILLAR	980	67890	2/1/2010



Always Available

Easy-Track includes a secure online database hosting your entire asset operation history. Management is notified with alerts for failed inspections, repairs and work order details. Various reports alert you to overdue service and inspections. Asset detail history includes: size, length, serial number, and part number. Complete backup download of your online database is also available.

Round Sling Inspection criteria

It is important to inspect your round slings after purchase.

Types of inspection

A. Initial Inspection - Before any new or repaired round sling is placed in service, it shall be inspected by a designated competent person to ensure that the correct round sling is being used, as well as to determine that the round sling meets the applicable requirements.

B. Frequent Inspection - This inspection should be conducted by the person handling the sling each time the sling is used.

C. Periodic Inspection - This inspection shall be conducted by the designated staff. Frequency of inspection should be based on frequency of round sling use, severity of service conditions and experience gained on the service life of round sling used in similar applications. Inspections should be conducted at least annually.

Remove the sling from service if any of the following is visible :

If sling rated capacity or sling material identification is missing or not legible

Acid or alkaline burns

Melting, charring or weld splatters on any part of the round sling

Holes, tears, cuts, snags or embedded particles

Broken or worn stitching in the cover, that exposes core yarns

Core yarns are broken or damaged during use that exposes core yarns

Knots in any part of the round sling

Excessive pitting, or corrosion, or cracked, or distorted, or broken fittings

Any other visible damage that causes doubt as to the strength of the sling



Exposed load bearing yarns



Seam of cover opening

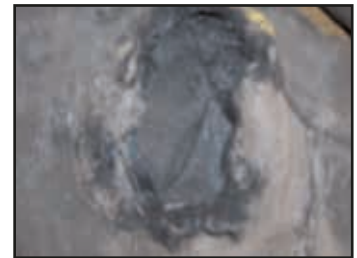

Melted or Charred areas

Inspection Records

Written inspection records, utilizing the identification for each sling as established by the user, should be kept on file for all round slings. These records should show a description of the sling and its condition on each periodic inspection.

Repair of Round Slings

There shall be no repairs of load bearing fibers. Repairs to the protective covers will be done by the original manufacturer. All repaired polyester round slings shall be proof tested to a minimum of 2 times rated vertical capacity.



Chain Sling Inspection criterias

It is important to inspect your chain slings after purchase.

Types of inspection

- A. **Initial Inspection** - Before any new or repaired chain sling is placed in service, it shall be inspected by a designated competent person to ensure that the correct chain sling is being used, as well as to determine that the chain sling meets the applicable requirements.
- B. **Frequent Inspection** - This inspection should be conducted by the person handling the sling each time the sling is used.
- C. **Periodic Inspection** - This inspection shall be conducted by the designated staff. Frequency of inspection should be based on frequency of chain sling use, severity of service conditions and experience gained on the service life of chain sling used in similar applications. Inspections should be conducted at least annually.

Remove the sling from service if any of the following is visible :

- If sling rated capacity or sling material identification is missing or not legible
- Cracks or breaks
- Excessive wear, nicks, or gouges
- Stretched chain links or components
- Bent, twisted, or deformed chain links or components
- Evidence of heat damage
- Excessive pitting, or corrosion
- Lack of ability of chain or components to hinge freely
- Weld splatter
- Any other visible damage that causes doubt as to the strength of the sling



Pitting & corrosion



Deformed components

Inspection Records

Written inspection records, utilizing the identification for each sling as established by the user, should be kept on file for all chain slings. These records should show a description of the sling and its condition on each periodic inspection.

Repair of Chain Slings

Cracked, broken, or bent chain links shall not be repaired, they shall be replaced. All repaired chain slings must be proof tested to twice the Vertical rated capacity.

Wire Rope Sling Inspection

It is important to inspect your wire rope sling after purchase.

TYPES OF INSPECTION

A. Initial Inspection - Before any new or repaired wire rope sling is placed in service, it shall be inspected by a designated competent person to ensure that the correct wire rope sling is being used, as well as to determine that the wire rope sling meets the applicable requirements.

B. Frequent Inspection - This inspection should be conducted by the person handling the sling each time the sling is used.

C. Periodic Inspection - This inspection shall be conducted by the designated staff. Frequency of inspection should be based on frequency of wire rope sling use, severity of service conditions and experience gained on the service life of wire rope sling used in similar applications. Inspections should be conducted at least annually.

Remove the sling from service if any of the following is visible :

- If sling rated capacity or sling material identification is missing or not legible
- Ten broken wires in one rope lay or five broken wires in one strand in one rope lay
- Severe localized abrasion or scraping
- Kinking, crushing, birdcaging, or any other damage resulting in damage to the rope structure
- Evidence of heat damage
- Severe corrosion of the rope
- Excessive pitting, or corrosion, or cracked, or distorted, or broken fittings
- Any other visible damage that causes doubt as to the strength of the sling



Bird caging



Corroded



Worn wires



Broken wires



Kinked



Crushed

Inspection Records

Written inspection records, utilizing the identification for each sling as established by the user, should be kept on file for all wire rope slings. These records should show a description of the sling and its condition on each periodic inspection.

Repair of Wire Rope Slings

There shall be no repairs done to the wire used in a wire rope sling. Repairs shall be restricted to end attachments and fittings, which will be deemed ok by the manufacturer.



In House Testing



With our numerous test beds, Ben-Mor can offer testing and certification up to 1 200 000 lbs x 100 ft. All slings tested come complete with the proof test certificate, and are logged online with EasyTrack.

BEN-MOR		CERTIFICATE		BEN-MOR										
Ben-Mor Cables Inc. confirms that goods described below have succeeded to test of capacity as required by client, according to type of product, raw material and types of uses recommended.														
Customer's name Shipment No. <u>YOUR COMPANY NAME</u> <u>VLL151930</u>			Certificate No Order No. <u>VCCO-166930</u> <u>BE271063</u>											
Material	Quantity	Code No	Diameter & Length	Description	BEN-MOR Serial No	CLIENT Part No	TYPES OF USES							
							WORKING LOAD LIMIT	LBS		Proof Test	Breaking Strength			
							Vertical	Choker	Horizontal	Diagonal	Shackles	Yokes	4:1	1:1
CHAIN	1	DOS	3" x 10'	EL G&E DEL 38 X 10' DOLA	VCCO-14859 - 1	114	N/A	N/A	12 000	10 000	7 100	28 400	N/A	N/A
REMARKS / Notes														
Date: <u>2015-05-03</u>														
1152 LINDEN, SAINT-HYACINTHE, QC, J2T 1A8 CANADA TEL: 450-779-0322 FAX: 450-779-0323 TEL: 800-461-0322 FAX: 800-468-0322						www.ben-mor.com								





Grade 43 High Tensile Chain - carbon steel

Grade 43 high tensile chain has a higher resistance to wear than Grade 30. It is a perfect product for farming and similar tasks.

Specifications

Diameter in.	Inside Dimensions in.		Working Load Limit lbs.	Weight / 100 ft. lbs.
	A	B		
1/4	1.24	.38	2,600	71
5/16	1.29	.44	3,900	102
3/8	1.38	.55	5,400	140
1/2	1.79	.72	9,200	234

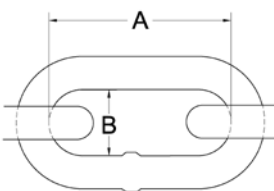

Safety Factor 3:1 Not intended for overhead lifting

Do not use for overhead lifting



Self colored

Drum		
Code	Diameter in.	Pack ft.
53030	1/4	400
53031	5/16	275
53032	3/8	200
53033	1/2	100



Zinc Plated

Pail		
Code	Diameter in.	Pack ft.
52039	1/4	100
51159	5/16	75
52041	3/8	45



Hot Dip Galvanized

Drum		
Code	Diameter in.	Pack ft.
53034	1/4	450
53035	5/16	275
53036	3/8	200
53037	3/8	400
53038	1/2	200

Stainless Steel Chain 316 L

Code	Diameter		Working Load Limit lbs.	Inside Dimensions in.		Weight / 100 ft. lbs.
	mm	in.		A	B	
CHS-564	2	5/64	70	0.48	0.14	5
CHS-018	4	1/8	400	0.91	0.27	20
CHS-316	5.5	3/16	800	0.96	0.40	40
CHS-014	7	1/4	1,300	1.18	0.43	66
CHS-516	8	5/16	1,700	1.26	0.50	86
CHS-038	10	3/8	2,650	1.31	0.60	142
CHS-012	13	1/2	4,500	1.79	0.72	242

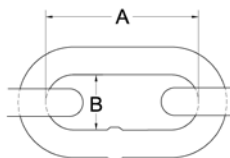

Safety Factor 4:1 Not intended for overhead lifting

Do not use for lifting





Grade 30 Proof Coil Chain - low carbon steel

A general utility chain for farm, industry and home applications.

Specifications

Diameter in.	Inside Dimensions in.		Working Load Limit lbs.	Weight / 100 ft. lbs.
	A	B		
1/8	0.925	.25	325	20
3/16	0.98	.34	630	29
1/4	1.34	.48	1,100	52
5/16	1.24	.50	1,900	85
3/8	1.35	.57	2,650	124
1/2	1.70	.75	4,500	234
5/8	2.20	.79	6,900	390
3/4	2.76	.98	10,600	537
1	3.60	1.25	17,900	941

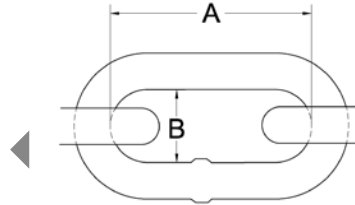

Safety Factor 4:1 **Not intended for overhead lifting**
Do not use for overhead lifting



Self colored

Drum		
Code	Diameter in.	Pack ft.
53000	1/8	1,250
53001	3/16	800
53002	1/4	450
53003	5/16	275
53004	3/8	200
53005	1/2	100

Pail		
Code	Diameter in.	Pack ft.
52000	1/8	250
52001	3/16	150
52002	1/4	100
52003	5/16	75
52006	5/16	90
52004	3/8	45
52005	1/2	25



Zinc Plated

Drum		
Code	Diameter in.	Pack ft.
53010	1/8	1,250
53011	3/16	800
53012	1/4	450
53013	5/16	275
53014	3/8	200
53015	1/2	100

Pail		
Code	Diameter in.	Pack ft.
52009	1/8	250
52010	3/16	150
52011	1/4	100
52012	5/16	75
52013	3/8	45
52014	1/2	25

Reel		
Code	Diameter in.	Pack ft.
51000	3/16	100
51001	1/4	65
51002	5/16	60
51003	3/8	35
51009	1/8	150



Hot Dip Galvanized

Drum 29 in.		
Code	Diameter in.	Pack ft.
53027	5/8	150
53028	3/4	100

Drum		
Code	Diameter in.	Pack ft.
53020	1/8	1,250
53021	3/16	800
53022	1/4	450
53023	5/16	275
53024	3/8	200
53025	1/2	100

Pail		
Code	Diameter in.	Pack ft.
52020	1/8	250
52021	3/16	150
52022	1/4	100
52023	5/16	75
52024	3/8	45
52025	1/2	25

For grade 70 see page 114
For grade 80 see page 66
For grade 100 see page 62



Machine Chain - low carbon steel

Machine chain is a short link chain used mainly where flexibility in a compact chain is required.

Straight Link

Code	Trade Size #	Dimensions in.			Working Load Limit lbs.	Pack ft.	Weight / 100 ft. lbs.	Packaging
		Dia.	Inside Length	Inside Width				
51011	# 2 (Zinc)	.150	.61	.26	325	125	19	Reel
56007	# 2 (Galv.)	.150	.61	.26	325	100	19	Reel
51012	# 3 (Brass)	.140	.59	.24	270	80	15	Reel
51010	# 4 (Zinc)	.120	.55	.21	215	100	11	Reel

Not intended for overhead lifting



Twist Link

Code	Trade Size #	Dimensions in.			Working Load Limit lbs.	Pack ft.	Weight / 100 ft. lbs.	Packaging
		Dia.	Inside Length	Inside Width				
51020	# 2 (Zinc)	.150	.58	.22	310	125	20	Reel
51021	# 4 (Zinc)	.120	.52	.17	200	100	13	Reel
51022	2/0 (Zinc)	.190	.73	.28	520	75	34	Reel
51063	2/0 (Zinc)	.190	.73	.28	520	150	34	Pail
51023	# 250 (Nickel)	.095	.42	.2	45	100	9	Reel

Not intended for overhead lifting



Passing Link Chain - low steel carbon

A general utility chain that resist kinking due to the link design.

Zinc

Code	Trade Size #	Dimensions in.			Working Load Limit lbs.	Pack ft.	Weight / 100 ft. lbs.	Packaging
		Dia.	Inside Length	Inside Width				
51035	2/0	.190	.88	.47	450	120	32	Reel
52037	2/0	.190	.88	.47	450	225	32	Pail

Not intended for overhead lifting



Harrow Chain

Self colored

Code	Trade Size #	Dimensions in.			Working Load Limit lbs.	Pack ft.	Weight / 100 ft. lbs.	Packaging
		Dia.	Inside Length	Inside Width				
56008	5/16	2.12	0.90	1,900	100	85	Special Pail	

Not intended for overhead lifting



Coil Chain - low carbon steel

Coil chains have longer links than machine chain. This product is perfect for animal tie chains, platform barriers and other similar tasks.

Straight Link

Code	Trade Size #	Dimensions in.			Working Load Limit lbs.	Pack ft.	Weight / 100 ft. lbs.	Packaging
		Dia.	Inside Length	Inside Width				
51017	2/0 (Zinc)	.190	1.29	.32	520	200	27	Pail
51015	# 4 (Zinc)	.120	1.11	.21	205	100	10	Reel
51016	2/0 (Zinc)	.190	1.29	.32	520	125	27	Reel
51018	# 2 (Zinc)	.148	1.18	.26	310	125	18	Reel

Not intended for overhead lifting



Twist Link

Code	Trade Size #	Dimensions in.			Working Load Limit lbs.	Pack ft.	Weight / 100 ft. lbs.	Packaging
		Dia.	Inside Length	Inside Width				
51025	# 3 (Bronze)	.140	1.14	.21	240	50	13	Reel

Not intended for overhead lifting



Endweld Utility Chain - steel

A standard chain for all purpose usage except lifting.

Zinc Plated

Code	Trade Size #	Dimensions in.			Working Load Limit lbs.	Pack ft.	Weight / 100 ft. lbs.	Packaging
		Dia.	Inside Length	Inside Width				
51030	# 14	.080	0.50	0.19	75	250	5	Reel

Not intended for overhead lifting





Double Loop Chain - steel

Code	Trade Size #	Dimensions in.			Working Load Limit lbs.	Pack ft.	Weight / 100 ft. lbs.	Packaging
		Dia.	Inside Length	Inside Width				
51145	# 1 (Zinc)	.105	1.54	.281	155	125	8	Reel
51052	# 1 (Zinc)	.105	1.54	.281	155	250	8	Reel
51067	# 1 (Zinc)	.105	1.54	.281	155	425	8	Pail
51057	# 2 (Zinc)	.091	1.33	.16	115	200	12	Reel
51053	# 3 (Zinc)	.080	1.10	.187	90	200	6	Reel
51059	# 3 (Zinc)	.080	1.10	.187	90	700	6	Special Pail
51054	# 4 (Zinc)	.072	1.02	.171	70	250	5	Reel
51051	# 1/0 (Zinc)	.120	1.78	.312	200	200	13	Reel
51146	# 1/0 (Polycoat white)	.120	1.78	.312	200	100	13	Reel
51050	# 2/0 (Zinc)	.135	1.82	.340	255	75	17	Reel
52059	# 2/0 (Polycoat white)	.135	1.82	.340	255	200	17	Pail
52146	# 2/0 (Zinc)	.135	1.82	.340	255	275	17	Pail
51062	# 3/0 (Zinc)	.148	2.17	.415	305	150	20	Pail

Not intended for overhead lifting



An economical utility chain used for swings, dog tie-outs, cow ties, etc (also called Tenso and Lion)

Vinyl Covered

Code	Trade Size #	Dimensions in.			Working Load Limit lbs.	Pack ft.	Weight / 100 ft. lbs.	Packaging
		Dia.	Inside Length	Inside Width				
51055	# 1/0 (Green)	.120	1.78	.312	200	100	17	Reel
51056	# 2 (Blue)	0.091	1.33	0.167	115	125	11	Reel

Not intended for overhead lifting



Lock Link Chain - steel

Zinc

Code	Trade Size #	Dimensions in.		Working Load Limit lbs.	Pack ft.	Weight / 100 ft. lbs.	Packaging
		Dia.	Inside Length				
51077	2/0	.140	1.48	340	50	23	Reel

Not intended for overhead lifting



The strongest weldless chain. Provides a flat suspension surface.

Furnace Chain - steel

Zinc

Code	Trade Size #	Thickness in.	Working Load Limit lbs.	Pack ft.	Weight / 100 ft. lbs.	Packaging
51070	# 91	.023	41	250	2.5	Reel

Not intended for overhead lifting



Light duty chain.

Single Jack Chain - steel

Ideal chain for hanging lighting fixtures, flower pots and other domestic type light objects.

Code	Trade Size #	Dimensions in.		Working Load Limit lbs.	Pack ft.	Weight / 100 ft. lbs.	Packaging
		Dia.	Inside Length				
51040	# 10 (Zinc)	.135	.93	43	150	12	Reel
51041	# 12 (Zinc)	.105	.77	29	100	9	Reel
51140	# 14 (Polycoat Black)	.080	.66	16	190	5	Reel
51047	# 14 (Black)	.080	.66	16	200	5	Reel
51042	# 14 (Zinc)	.080	.66	16	200	5	Reel
51043	# 16 (Zinc)	.062	.52	11	250	2.75	Reel
51046	# 16 (Bronze)	.062	.52	11	250	2.75	Reel
51038	# 18 (Zinc)	.047	.39	5	200	1.7	Reel

Not intended for overhead lifting

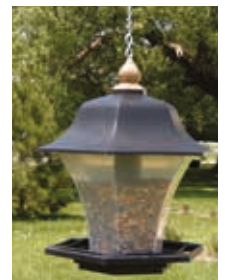

Double Jack Chain - steel

Chain similar to the single jack chain with a sturdier construction.

Code	Trade Size #	Dimensions in.		Working Load Limit lbs.	Pack ft.	Weight / 100 ft. lbs.	Packaging
		Dia.	Inside Length				
51075	# 16 (Brass Pl.)	.058	.22	11	200	6	Reel
51076	# 16 (Zinc Pl.)	.058	.22	11	200	6	Reel

Not intended for overhead lifting



Plastic Chain

Code	Trade Size #	Dimensions in.			Working Load Limit lbs.	Pack ft.	Weight / 100 ft. lbs.	Packaging
		Dia.	Inside Length	Inside Width				
54000	# 6 (1-1/2") White	.230	1.00	.30	50	130	5	Pail
54001	# 6 (1-1/2") Black	.230	1.00	.30	50	130	5	Pail
54006	# 6 (1-1/2") Yellow	.230	1.00	.30	50	130	5	Pail
54002	# 8 (2") White	.290	1.50	.40	75	70	7	Pail
54003	# 8 (2") Black	.290	1.50	.40	75	70	7	Pail

Not intended for overhead lifting



Cathedral Chain - steel

Code	Trade Size #	Dimensions in.			Working Load Limit lbs.	Pack ft.	Weight / 100 ft. lbs.	Packaging
		Dia.	Inside Length	Inside Width				
51090	#31 Bronze	.087	.985	.552	35	98	6	Reel

Not intended for overhead lifting



Decorative Oval Chain (Swag)

Code	Trade Size #	Dimensions in.			Working Load Limit lbs.	Pack ft.	Weight / 100 ft. lbs.	Packaging
		Dia.	Inside Length	Largeur int.				
51105	# 4 Zinc Plated	.120	.58	.210	70	90	11	Reel
51080	# 10 Brass Plated	.109	1.25	.625	45	50	7	Reel
51081	# 10 Black	.109	1.25	.625	45	50	7	Reel
51083	# 10 White	.109	1.25	.625	45	50	7	Reel
51084	# 10 Aged Bronze	.109	1.25	.625	45	50	7	Reel
51085	# 10 Antique Copper	.109	1.25	.625	45	50	7	Reel
51088	# 10 Satin Chrome	.109	1.25	.625	45	50	7	Reel
51089	# 10 Oil Rubbed Bronze	.109	1.25	.625	45	50	7	Reel
51127	# 100 Black	.087	.63	.240	13	197	3	Reel
51125	#19 Brass Plated	.043	.205	.110	7	82	2	Reel

Not intended for overhead lifting



Sash Chain - steel

Zinc

Code	Trade Size #	Thickness in.	Working Load Limit lbs.	Pack ft.	Weight / 100 ft. lbs.	Packaging
51060	# 8	.029	75	200	4	Reel
51061	# 35	.035	106	100	6	Reel

Not intended for overhead lifting



This chain is designed to operate smoothly over pulleys, it is ideal for many applications such as hanging and suspending double hung sashes.

Safety Chain - brass

Laiton

Code	Trade Size #	Thickness in.	Working Load Limit lbs.	Pack ft.	Weight / 100 ft. lbs.	Packaging
51065	1/0	.023	35	200	2	Reel

Not intended for overhead lifting



This flat link chain is commonly used for plumbing fixtures.

Electrical Fixture Chain

Code	Trade Size #	Dimensions in.			Working Load Limit lbs.	Pack ft.	Weight lbs.	Packaging
		Dia.	Inside Length	Inside Width				
52517	# 3 Double loop	.080	1.10	.187	90	800 (8 x 100')	48	Box
51054	# 4 Double loop	.072	1.02	.171	70	250	12.5	Reel
51039	# 10T Single Jack	.125	1.26	-	43	500 (10 x 50')	60	Box
52113	# 10T Single Jack	.125	1.26	-	43	250	30	Reel

Not intended for overhead lifting

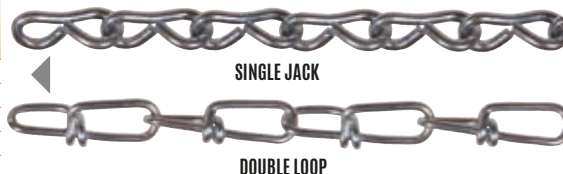

SINGLE JACK

DOUBLE LOOP

"S" Hook For Fixture Chain, #105

Code	Type	Size or Diameter in.	Inside Length in.	Weight / box lbs.	Packaging	Qty/Pack	Pack/CTN
70929	Crochet en «S»	1/8	1.25	14	Boite	1,000 (10x100)	1

Not intended for overhead lifting





Bead Chain

Code	Trade Size #	Dia. & Ins. Dim. in.	Working Load Limit lbs.	Pack ft.	Weight / 100 ft. lbs.	Packaging
51130	51130 #6 Steel Nickel Plated	.125 dia.	6	100	2	Reel
51132	#6 Brass Bright	.125 dia.	6	100	2	Reel
51131	51131 #10 Steel Nickel Plated	.178 dia.	12	100	3	Reel
51135	51135 #10 Brass Nickel Plated	.178 dia.	12	100	3	Reel



Not intended for overhead lifting

Bead Chain Connectors - steel

Code	Trade Size # Finish	Packaging	Qty/Pack	Pack/CTN
55000	#6 Brass Bright	Bag	100	1
55002	#6 Nickel	Bag	100	1
55030	#6 Brass	Card	8	1
55004	#6 Nickel	Card	6	10
55001	#10 Brass Bright	Bag	100	10
55003	#10 Nickel	Bag	100	1
55031	#10 Nickel	Card	8	10



Not intended for overhead lifting

Hobby / Craft Chain - steel

Code	Trade Size #	Dimensions in.			Working Load Limit lbs.	Pack ft.	Weight / 100 ft. lbs.	Packaging
		Dia.	Inside Length	Inside Width				
51111	#5 Clock Brass Plated	.051	.315	.105	13	82	1.3	Reel
51112	#5 Clock Nickel Plated	.051	.315	.105	13	82	1.3	Reel
51114	#7 Clock Nickel Plated	.063	.315	.130	18	82	1.6	Reel
51115	#2 Sash Chrome Plated	.043 ga	-	.532	29	164	.7	Reel
51117	#3 Sash Chrome Plated	.059 ga	-	.519	35	82	2.0	Reel
51118	#70 Twist Brass Plated	.047	.154	.030	15	82	2.6	Reel
51119	#90 Twist Brass Plated	.059	.260	.122	20	82	3.5	Reel
51120	#90 Twist Nickel Plated	.059	.260	.122	20	82	3.5	Reel
51121	#200 Twist Brass Plated	.079	.360	.122	29	49	4.7	Reel
51122	#200 Twist Nickel Plated	.079	.360	.122	29	49	4.7	Reel
51123	#250 Twist Brass Plated	.099	.284	.170	35	33	8.5	Reel
51124	#250 Twist Nickel	.099	.284	.170	35	33	8.5	Reel
51125	#19 Oval Link Brass Plated	.043	.205	.110	7	82	2.1	Reel
51126	51126 #36 Ball Chain Chrome Plated	.142	-	-	11	164	1.6	Reel



CLOCK



SASH



TWIST



OVAL



BALL

Not intended for overhead lifting

Replacement Links (Hot dip galvanized, forged steel, quenched and tempered)

Code	Chain Dimension in.	Working Load Limit lbs.	Weight / 100 ft. lbs.	Dimensions in.			
				A	B	C	E
G335-316	3/16	800	2.50	.69	.34	.78	1.19
G335-014	1/4	1,325	6.25	.88	.44	1.00	1.50
G335-516	5/16	1,950	12.50	.94	.47	1.16	1.69
G335-038	3/8	2,750	20.00	1.13	.56	1.38	2.06
G335-716	7/16	3,625	27.50	1.28	.59	1.53	2.34
G335-012	1/2	4,750	37.50	1.47	.66	1.72	2.66
G335-058	5/8	7,250	72.50	1.81	.78	2.09	3.31
G335-034	3/4	10,250	122.50	2.13	.94	2.50	3.88
G335-078	7/8	12,000	175.00	2.50	1.13	2.94	4.50
G335-001	1	15,500	250.00	2.75	1.25	3.31	5.00

Safety Factor 3:1

Not intended for overhead lifting

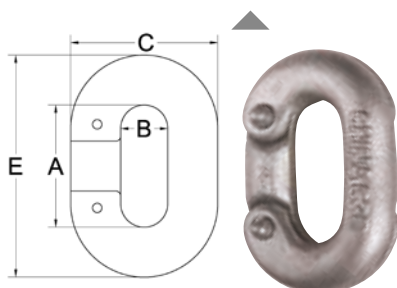

Lap Links (zinc plated steel, cold drawn mild steel)

Code	Chain Dimension in.	Weight / each lbs.	Dimensions in.
			A
LAPZ-018	1/8	0.01	3/4
LAPZ-316	3/16	0.03	1
LAPZ-014	1/4	0.07	1 1/2
LAPZ-516	5/16	0.13	1 1/2
LAPZ-038	3/8	0.26	2
LAPZ-716	7/16	0.56	2 1/4
LAPZ-012	1/2	0.53	2 1/2

Not intended for overhead lifting

Federal Specification : RR-C-2716-16

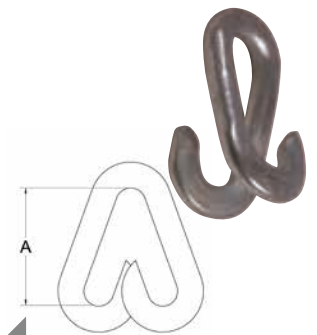

Cold Shuts (zinc plated steel, mild steel)

Code	Chain Dimension in.	Weight / each lbs.	Dimensions in.	
			A	B
MF-316	3/16	0.03	15/16	11/32
MF-014	1/4	0.06	1	3/8
MF-516	5/16	0.10	1 3/16	7/16
MF-038	3/8	0.18	1 5/16	5/8
MF-716	7/16	0.27	1 1/2	9/16
MF-012	1/2	0.38	1 9/16	3/4

Not intended for overhead lifting

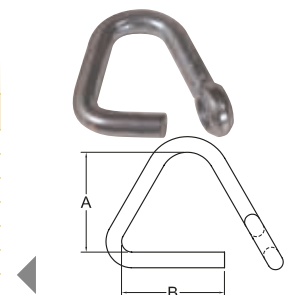



AMSTEEL BLUE ROPE

Diameter in.	lbs. / 100 ft.	Tensile Strength lbs.
7/64	0.3	1,600
1/8	0.5	2,500
3/16	1.0	5,400
1/4	1.6	8,600
5/16	2.7	13,700
3/8	3.6	19,600
7/16	4.2	23,900
1/2	6.4	34,000
9/16	7.9	40,500
5/8	10.2	52,800
3/4	13.3	64,400
7/8	19.6	90,800
1	21.8	109,000

AmSteel® Blue rope is a 12 strand braided rope utilizing Parallax design without proprietary blue Samthane coating with Dyneema® SK-75 fibre. This rope yields the maximum in strength-to-weight ratio and is stronger than wire rope construction - yet it floats. It has superior flex, fatigue and wear resistance. AmSteel® Blue is stronger than wire and has the same elongation as wire, 10% at .46%, 20% at .7% and 30% at .96%.



STABLE BRAID - Uncoated Polyester Rope

Diameter in.	lbs. / 100 ft.	Force de rupture lb	Minimum Tensile Strength (Spliced) lbs.
1/4	2.1	2,300	2,000
5/16	3.2	3,600	3,100
3/8	4.5	5,600	4,800
7/16	6.1	7,700	6,500
1/2	8.2	10,400	8,800
9/16	11.0	13,300	11,300
5/8	14.0	16,300	13,900
3/4	18.0	20,400	17,300
7/8	27.1	29,900	25,400
1	34.0	39,200	33,300
1 1/8	45.3	48,200	41,000
1 1/4	53.9	57,300	48,700
1 5/16	60.8	64,700	55,000
1 1/2	73.3	75,100	63,800
1 5/8	85.9	87,200	74,100

A firm, polyester, double braided rope with high strength, low stretch, and excellent resistance to wear. If meeting military specifications is required, please state when ordering or requesting a quote.



AMSTEEL II ROPE

Diameter in.	lbs. / 100 ft.	Tensile Strength lbs.
1/4	2.2	4,600
5/16	3.5	7,500
3/8	4.1	9,800
7/16	6.1	11,700
1/2	8.6	15,500
9/16	10.0	22,000
5/8	12.6	27,000
3/4	16.0	35,000
13/16	20.3	40,000
7/8	24.8	50,000
1	29.7	57,000

A double braided rope that derives its high strength from a braided Dyneema® fibre core. The braided polyester cover creates a firm rope and serves as abrasion protection to the strength core. This rope has extremely low elongation 10% at .5%, 20% at .67% and 30% at .96% of break strength and is a light-weight replacement for wire rope. Can be used for trawl, bridle, purse seine and winch.



TENEX ROPE

Tenex Rope

Diameter in.	lbs. / 100 ft.	Tensile Strength lbs.
1/4	2.1	3,200
5/16	3.2	4,700
3/8	4.2	5,800
7/16	6.3	9,000
1/2	8.5	11,800
9/16	10.0	15,000
5/8	13.1	17,100
3/4	17.2	22,400
7/8	25.8	32,600
1	34.5	42,700

Tenex is a 12 strand, Samthane-coated, high-tenacity polyester rope offering high strength coupled with low stretch and outstanding abrasion resistance. Its abrasion resistance and firmness is due to a special Samthane coating which allows for easy splicing while enhancing wear life and snag resistance. A viable alternative to using double braids when easy field slicing and economy are major considerations. Tenex has elastic elongation ratings at 10% at 1.4%, 20% at 2.3%, and 30% at 3% of break strength. This rope can be used for trawl, bridle, Gillnet lead, cork, Purse seine, Pulling and stringing line. It is also used for rodeo, rigging and utility purposes.





Twisted Polypropylene Rope, 3 Strands

Code	Diameter		Length		Color	Packaging	Pack/CTN
	mm	in.	m	ft.			
60167	4.8	3/16	648	2,125	Yellow	Reel	1
60191	6.4	1/4	396	1,300	Yellow	Reel	1
60193	7.9	5/16	122	400	Yellow	Reel	1
60196	7.9	5/16	274	900	Yellow	Reel	1
60213	9.5	3/8	183	630	Yellow	Reel	1
60254	9.5	3/8	183	630	Red	Reel	1
60215	12.7	1/2	102	335	Yellow	Reel	1
60251	12.7	1/2	102	335	Red	Reel	1
60223	16	5/8	61	200	Yellow	Reel	1
60229	19	3/4	48	150	Yellow	Reel	1

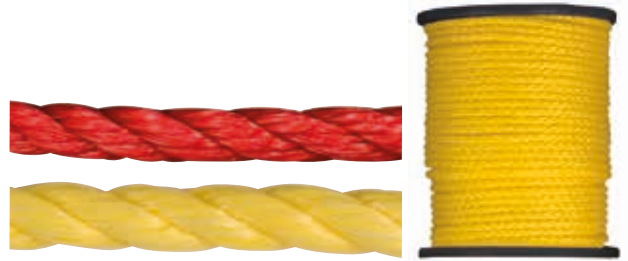

An economical, durable, lightweight, general-purpose cord that floats. It is also resistant to oil, gas and mould. It is used widely in industry, business and construction and for residential use.

High Performance Winch Rope Dynasteel™

Code	Diameter		Length		Color	Packaging
	mm	in.	m	ft.		
WCD-316050	4.8	3/16	15	50	Blue	Bag
WCD-014050	6.4	1/4	15	50	Blue	Bag

Not intended for overhead lifting



An alternative to wire rope at 1/7th the weight of same size wire rope. This rope will not rust, is non-rotational and has same stretch attributes as wire rope.

High Performance Rope Dynasteel™

Code	Diameter		Color	Tensile Strength	Tensile Strength
	mm	in.		(new) lbs.	(Spliced) lbs.
60806	4	3/16	Blue	5,000	4,600
60806-600	4	3/16	Blue	5,000	4,600
60806-5000	4	3/16	Blue	5,000	4,600
60803	6.4	1/4	Blue	8,000	7,400
60803-600	6.4	1/4	Blue	8,000	7,400
60804	8	5/16	Blue	12,600	11,800
60805	9	3/8	Blue	18,000	17,000
60805-600	9	3/8	Blue	18,000	17,000
60805-5000	9	3/8	Blue	18,000	17,000
60808	11.1	7/16	Blue	23,900	21,600
60808-600	11.1	7/16	Blue	23,900	21,600
60808-2000	11.1	7/16	Blue	23,900	21,600
60809	12.7	1/2	Blue	32,000	30,000
60809-600	12.7	1/2	Blue	32,000	30,000

Features :

- Abrasion resistant
- Easy to inspect
- Easy to splice
- Excellent wear characteristics
- Very low stretch
- Flexible
- Floats
- Fatigue resistant
- Lightweight
- Maximum strength-to-weight ratio
- Similar elastic elongation to wire rope
- Torque-free construction
- Wire rope replacement



Applications :

- Lifeline
- Lifting Sling
- Synthetic winch cable

Heavy Duty Nylon 2/1 Rope

Code	Diameter		Color	Tensile Strength	Tensile Strength
	mm	in.		(new) lbs.	(Spliced) lbs.
60817	9.5	3/8	White	3,700	3,300
60819	12.7	1/2	White	6,526	5,800
60821	16	5/8	White	10,200	9,100
60823	19	3/4	White	14,500	13,000
60824	25.4	1	White	25,225	22,700
60825	32	1 1/4	White	38,700	34,800
60826	38	1 1/2	White	55,000	49,500
60828	51	2	White	96,900	87,200

Features :

- Durable
- Excellent shock mitigation
- Firm construction
- Remains flexible with use
- Shrink resistant



Applications :

- Anchor and other marine applications
- General Working Line
- Lifting Sling

A lightweight hoist that's anything but a lightweight.

The L5LB forged an entirely new, industry-leading benchmark by being smaller, lighter and stronger than any other lever hoist on the market. Its proven strength and durability stand up in an endless array of gruelling applications, including environments where temperatures drop to a bonechilling -40 C.

CAPACITY

• $\frac{3}{4}$ to 9 metric tons

STANDARDS

- ASME B30.21 Safety Standard
- ASME HST-3 Performance Standard

OPTIONAL OVERLOAD PROTECTION

Slip Clutch: Engages during an excessive overload keeping the load stationary

Patented Hardening Process

An advanced high-frequency heat treating process ensures uniform hardness on all key load bearing parts. The process creates a truly rugged hoist you can confidently take into any environment.



FAILSAFE FREEWHEEL SYSTEM

Our widely acclaimed fail-safe freewheel system closes the gap between operator safety and load control. Developed in-house 30 years ago, the freewheel mechanism was intentionally created as a two-step process to eliminate the risk of accidental free chaining. The result is dramatically improved functionality and operator safety.

TECHNICAL INFO

Steel Body Lever Chain Hoist (/product_configurations/1)

SINGLE FALL LEVER HOIST

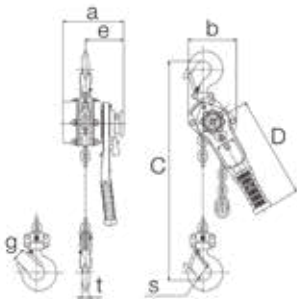

L5LB $\frac{3}{4}$ - 3 Metric Ton

*For informational purposes only, contact KITO for dimensional drawing

DOUBLE FALL LEVER HOIST

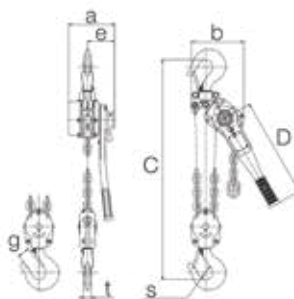

L5LB 6 Metric Ton

*For informational purposes only, contact KITO for dimensional drawing

TRIPLE FALL LEVER HOIST

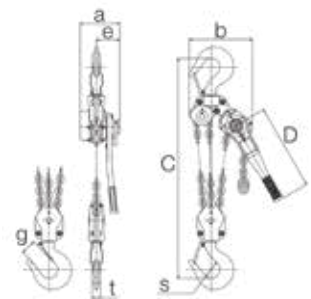

L5LB 9 Metric Ton

*For informational purposes only, contact KITO for dimensional drawing

Dimensions

Capacity (TON)	Model	C	D	a	b	e	g	s	t
$\frac{3}{4}$	L5LB008	280	245	144	119	97	23.5	35.5	14
1½	L5LB015	335	265	159	126	100	32	42.5	19
2½	L5LB025	375	265	173	150	102	36.5	47	21
3	L5LB030	395	415	190	159	112	39	50	24.5
6	L5LB060	540	415	190	217	112	50	60	34
9	L5LB090	680	415	190	304	112	72.5	85	41.5

Specifications

Capacity (TON)	Model	Standard Lift (ft.)	Hand Pull to Lift Full Load (kg)	Headroom (in.)	Handle Length (in.)	Load Chain Code	Load Chain Falls	Ship weight (lbs.)	Weight per Additional 5ft of Lift (lbs.)
$\frac{3}{4}$	L5LB008	5	27	11	9.75	KLB5056	1	13	3
1½	L5LB015	5	32	13.25	10.5	KLB5071	1	18	4
2½	L5LB025	5	37	14.75	10.5	KLB5088	1	25	6
3	L5LB030	5	35	15.5	16.5	KLB5100	1	33	8
6	L5LB060	5	36	21.25	16.5	KLB5100	2	57	16
9	L5LB090	5	39	26.75	16.5	KLB5100	3	88	24

Plate Clamp

Code	Jaw Opening in.
1/2 TON	0 - 3/4
	1/2 - 1
	3/4 - 1 1/2
	1 - 1 1/2
	1 1/4 - 1 3/4
1 TON	0 - 3/4
	1/2 - 1
	3/4 - 1 1/2
	1 - 1 1/2
	1 1/4 - 1 3/4
2 TON	1 1/2 - 2
	0 - 1
	3/4 - 1 1/2
	1 1/4 - 2
	1 3/4 - 2 1/2
3 TON	0 - 1 1/4
	3/4 - 1 1/2
	1 1/4 - 2
	1 3/4 - 2 1/2

Model FR

PLATE CLAMP

The Model FR is a vertical lifting tool for relatively light work. It is small and easy to handle in capacities through three tons. It incorporates a "Lock Closed" feature which facilitates attaching the clamp to the plate.

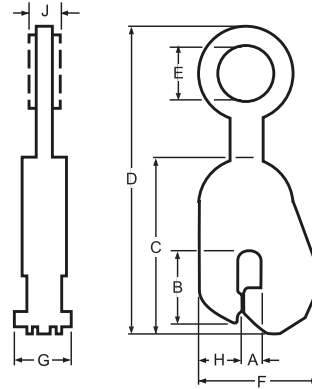

Custom Made Certified Spreader and Lifting Beams

Different designs available. Contact our sales department for details.

Spreader Beams

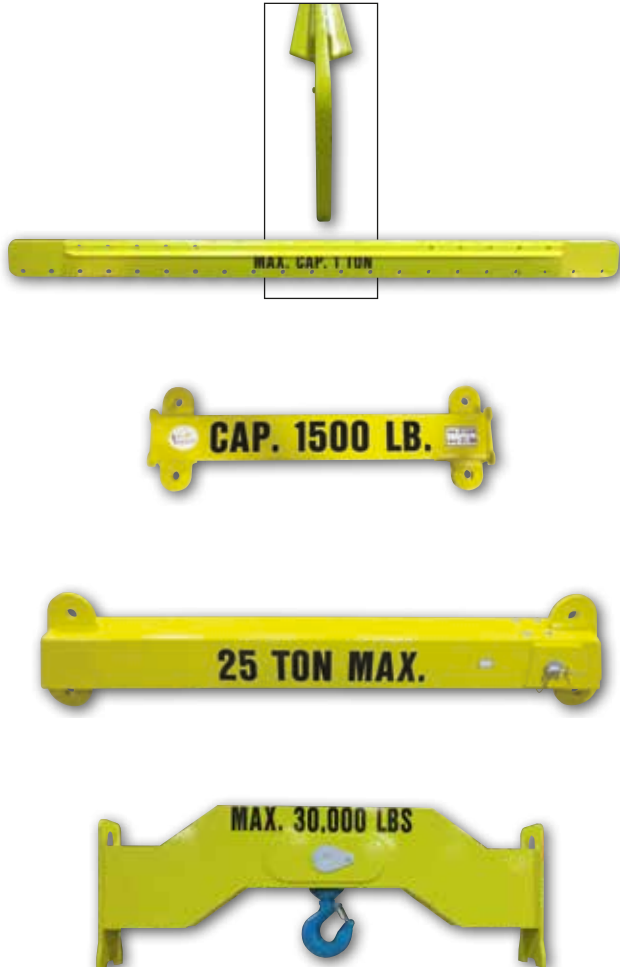

Lifting Beams

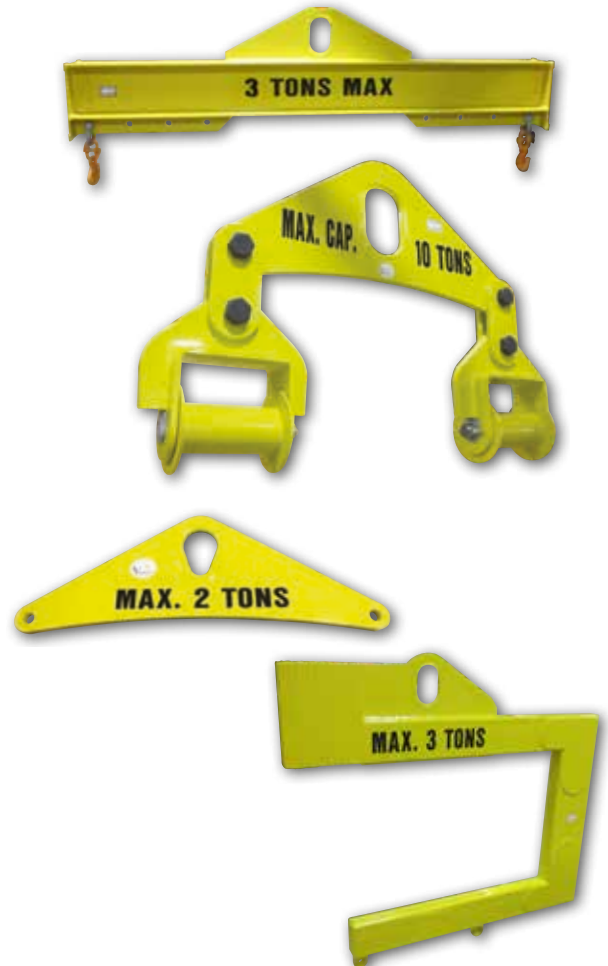

Hand Swagers, 1 cavity

Code	For Oval Sleeves	For Stop Sleeves	For Oval Sleeves Stainless Steel	Length in.	Weight ea. lbs.	Made in
HS-0A	3/64	3/64	5/64 - 1/16	20	4	USA
HS-0B	1/16	1/16	3/32	20	4	USA
HS-0C	3/32	3/32 - 1/8	1/8	20	4	USA
HS-0D	1/8	5/32 - 3/16 - 7/32	5/32	20	4	USA
HS-0E	5/32	-	3/16	20	4	USA
HS-0F	3/16	-	7/32	20	4	USA



Code	For Oval Sleeves	For Stop Sleeves	Length in.	Weight ea. lbs.	Made in
HS-1A	7/32	7/32	28	5	USA
HS-1B	1/4	1/4 - 9/32 - 5/16	28	5	USA
HS-1D	5/16	-	28	5	USA
HS-1E	3/8	-	37	13	USA
HS-1F	1/4 - 5/16	-	39	17	Japon



Code	For Oval Sleeves	For Stop Sleeves	Length in.	Weight ea. lbs.	Made in
S132	1/32	1/32	8	8	USA
S1532	3/64	3/64	8	8	USA
S232	1/16	1/16	8	8	USA



Functional Swagers

Code	For Oval Sleeves	For Stop Sleeves	Length in.	Weight ea. lbs.	Made in
HS-2	3/64 - 1/16 - 3/32	3/64 - 1/16 - 3/32 - 1/8	14	4	USA
HS-2A	1/16 - 3/32	1/16 - 3/32 - 1/8	19	3	Japon
70292	1/16 - 3/16	1/16 - 3/16	26	6	Chine



Pocket Hand Swagers

Code	For Oval Sleeves	For Stop Sleeves	Length in.	Weight ea. oz.	Made in
HS-3	1/32 - 3/64 - 1/16	1/32 - 3/64 - 1/16	10	12	USA



Multicompression Hand Swagers with Cable Cutter

Length : 26" – Weight : 6.5 lbs.

Code	For Oval Sleeves	For Stop Sleeves	Length in.	Weight ea. lbs.	Made in
JPS-24	1/16 - 3/32 - 1/8 - 5/32 - 3/16	1/16 - 3/32 - 1/8 - 5/32 - 3/16	24	6.5	Chine
HS-5	1/16 - 3/32 - 1/8 - 5/32 - 3/16	1/16 - 3/32 - 1/8 - 5/32 - 3/16 - 7/32	26	6.5	Japon



Bench Swagers

Length 22", Height 6.25" (height with handle up 24"), Weight 6.6 lbs.

Code	For Oval Sleeves	For Stop Sleeves	Length in.	Weight ea. lbs.	Made in
BS-1	1/16 - 3/32 - 1/8 - 5/32 - 3/16	1/16 - 3/32 - 1/8 - 5/32 - 3/16 - 7/32	22	6.6	Japon



Properly swaged aluminum and copper oval sleeves and duplex will develop the published nominal break strength of the cable on 3x7, 7x7, and 7x19 constructions. Sleeves used on other constructions will not hold to the nominal published break strength.

Stop sleeves will not hold to the nominal published break strength of any cable.

We recommend the use of a mechanical or hydraulic swager to obtain the full holding power of stainless steel oval sleeves.

Sleeves and other fittings swaged over a plastic jacket will not hold to the nominal published break strength of the cable.

To determine the actual holding strength of any fitting, a pull test must be made.

This will assist in determining if the applied fitting is suitable for your application.





“Felco” Wire Rope Cutters, Switzerland

Code	For cable diameter in.	Length in.	Weight ea. lbs.
FC-7	0 – 3/16	8	0.625
FC-9	0 – 1/4	13	1.500
FC-12	0 – 3/8	19	3.000
FC-16	0 – 5/8	23	5.000



Wire Rope Cutters, Japan

Code	For cable diameter in.	Length in.	Weight ea. lbs.	Made in
RC-8PRO	Up to 3/16	8	0.66	Japan
70293	Up to 3/16	8	0.66	China
RC-450	Up to 1/2	19	3.31	Japan
RC-800	Up to 5/8	31.5	8.60	Japan



Wire Rope Cutter, USA

Code	For cable diameter in.	Length in.	Weight ea. lbs.
C632	Up to 3/16	8	5.5



Hammer Cable Cutters

Code	Description	For cable diameter in.
SFCC-1	Model #1	Up to 3/4
SFCC-1A	Model #1A	Up to 1 1/16
SFCC-2	Model #2	Up to 1 1/2



Spare Parts

Code	Description	For cable diameter in.
SFPIS-1	Piston for Model #1	0 – 3/4
SFPIS-1A	Piston for Model#1A	0 – 1 1/16
SFPIS-2	Piston for Model#2	0 – 1 1/2
SFTB-1-1A	Top blade + pin for Model #1 and 1A	(0 – 3/4) and (0 – 1 1/16)
SFTB-2	Top Blade + pin for Model #2	0 – 1 1/2
SFBB-1	Bottom blade(pair) for Model #1	0 – 3/4
SFBB-1A	Bottom blade (pair) for Model #1A	0 – 1 1/16
SFBB-2	Bottom blade (pair) for Model #2	0 – 1 1/2





1" Tail straps

Code	End Hardware	Length in.	Working Load Limit lbs.
TSRWH1-12	Ratchet tail strap - wire hook	12	1 100
TSRSH1-12	Ratchet tail strap - vinyl «S» hook	12	800
TSRFH1-12	Ratchet tail strap - flat hook	12	1 100
TSWH1-12	Eye Tail strap - wire hook	12	1 100
TSSH1-12	Eye Tail strap - vinyl «S» hook	12	800
TSFH1-12	Eye Tail strap - flat hook	12	1 100

Custom sizes available.

Not intended for overhead lifting

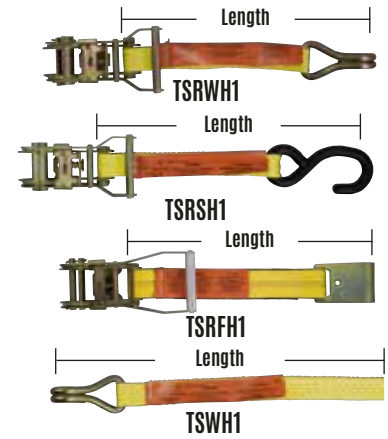

2", 3" & 4" Tail straps

Code	End Hardware	Width in.	Length in.	Working Load Limit lbs.
TRWH2-18	Ratchet tail strap - wire hook	2	18	3335
TSRFH2-18	Ratchet tail strap - flat hook	2	18	3335
TSRFH4-18	Ratchet tail strap - flat hook	4	18	5400
TSRCA2-33	Ratchet tail strap - Chain Assembly	2	33	3335
TSWH2-12	Eye Tail strap - wire hook	2	12	3335
TSFH2-12	Eye Tail strap - flat hook	2	12	3335
TSCA2-30	Eye Tail strap - Chain Assembly	S	30	3335
TSCA4-18	Eye Tail strap - Chain Assembly	4	18	6600
RSFH4-30	Flat hook	4	30	5400
RSCA2-25	Chain Assembly	2	25	3335
RSCA2-30	Chain Assembly	2	30	3335
RSCA3-30	Chain Assembly	3	30	5400
RSCA4-30	Chain Assembly	4	30	6600

Custom sizes available.

Not intended for overhead lifting

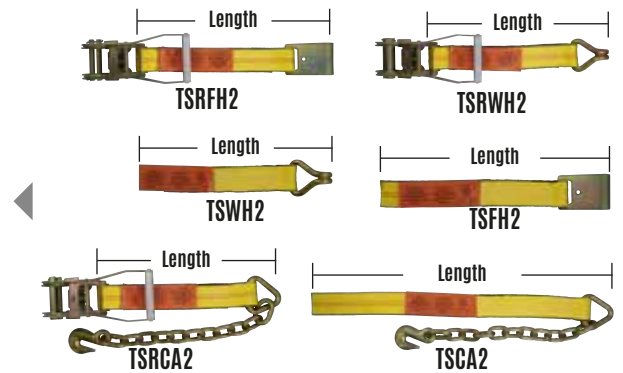

2", 3" & 4" Ratchet Endless Straps

Code	End Hardware	Width in.	Length ft.	Working Load Limit lbs.
RSEN2-15	Endless	2	15	3335
RSEN2-20	Endless	2	20	3335
RSEN2-25	Endless	2	25	3335
RSDR2-30	Delta ring	2	30	3335
RSDR3-30	Delta ring	3	30	5400
RSDR4-30	Delta ring	4	30	6600

Custom sizes available.

Not intended for overhead lifting

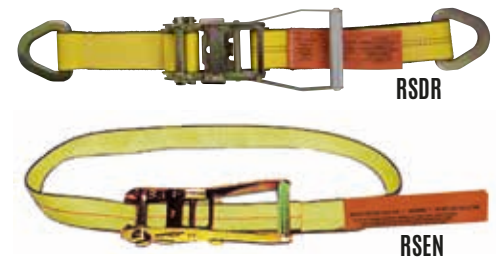

2" Endless Straps

Code	End Hardware	Width in.	Length ft.	Working Load Limit lbs.
CSEN2-15	Cambuckle	2	15	1000
CSEN2-30	Cambuckle	2	30	1000

Custom sizes available.

Not intended for overhead lifting

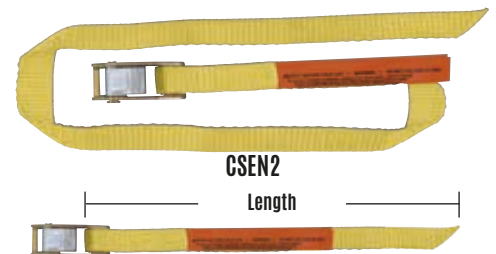

WARNING: The maximum loads shown are applicable only for new products or in perfect condition.

Do not exceed maximum rated capacities.



1" Ratchet Straps

Code	End Hardware	Length ft.	Working Load Limit lbs.	Tail end
RSWH1-10	Wire hook	10	1 100	12"
RSWH1-15	Wire hook	15	1 100	12"
RSSH1-10	Vinyl «S» hook	10	800	12"
RSSH1-15	Vinyl «S» hook	15	800	12"
RSFH1-10	Flat hook	10	1 100	12"
RSFH1-15	Flat hook	15	1 100	12"

Custom sizes available.

Not intended for overhead lifting

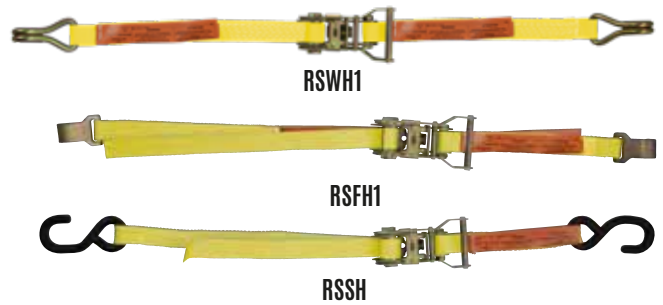

1" Blue Ratchet Straps

Code	End Hardware	Length ft.	Working Load Limit lbs.	Tail end
RSWH1-12 BLUE	Wire hook	12	1 100	12"
RSWH1-16 BLUE	Wire hook	16	1 100	12"
RSWH1-20 BLUE	Wire hook	20	1 100	12"
RSSH1-10 BLUE	Vinyl «S» hook	10	800	12"
RSSH1-16 BLUE	Vinyl «S» hook	16	800	12"
CSSH1-6 BLUE	Cam Strap - vinyl «S» hook	6	360	12"
RSWHD1-16 BLUE	Wire hook & Delta ring	16	1 100	12"

Custom sizes available.

Not intended for overhead lifting



2", 3" & 4" Ratchet straps

Code	End Hardware	Width in.	Length ft.	Working Load Limit lbs.	Tail end
RSWH2-20	Wire Hook	2	20	3335	18"
RSWH2-25	Wire Hook	2	25	3335	18"
RSWH2-27	Wire Hook	2	27	3335	18"
RSWH2-30	Wire Hook	2	30	3335	18"
RSWH3-30	Wire Hook	3	30	5400	18"
RSFH2-25	Flat hook	2	25	3335	18"
RSFH2-30	Flat hook	2	30	3335	18"
RSFH3-30	Flat hook	3	30	5400	18"
RSFH4-30	Flat hook	4	30	5400	18"
RSCA2-25	Chain Assembly	2	25	3335	18"
RSCA2-30	Chain Assembly	2	30	3335	18"
RSCA3-30	Chain Assembly	3	30	5400	18"
RSCA4-30	Chain Assembly	4	30	6600	18"
RSFSH2-15SAT	Flat snap hook	2	15	2200	18"
RSTSH2-15SAT	Twist snap hook	2	15	2200	18"
LDRSEF2-16	E-Track	2	16	1460	18"

Custom sizes available.

Not intended for overhead lifting



WARNING: The maximum loads shown are applicable only for new products or in perfect condition.

WARNING: Do not exceed maximum rated capacities.



1" Winch Straps

Code	End Hardware	Length ft.	Working Load Limits lbs.
WSWH1-10	Wire hook	10	1 100
WSWH1-15	Wire hook	15	1 100
WSSH1-10	Vinyl «S» hook	10	800
WSSH1-15	Vinyl «S» hook	15	800
WSFH1-10	Flat hook	10	1 100
WSFH1-15	Flat hook	15	1 100

Custom sizes available.

Not intended for overhead lifting

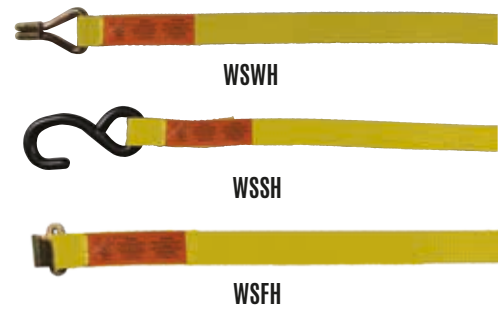

2", 3" & 4" Winch Straps

Code	End Hardware	Width in.	Length ft.	Working Load Limits lbs.
WSWH2-30	Wire hook	2	30	3335
WSWH3-30	Wire hook	3	30	5000
WSFE2-30	Eye	2	30	3335
WSFH2-30	Flat hook	2	30	3335
WSFH3-30	Flat hook	3	30	5400
WSFH4-30	Flat hook	4	30	5400
WSCA2-30	Chain 5/16" Assembly	2	30	3335
WSCA3-30-CA516	Chain 5/16" Assembly	3	30	5400
WSCA3-30-CA038	Chain 3/8" Assembly	3	30	5400
WSCA4-30	Chain 3/8" Assembly	4	30	6600
WSDR2-30	Delta ring	2	30	3300
WSDR3-30	Delta ring	3	30	5400











Custom sizes available.

Not intended for overhead lifting

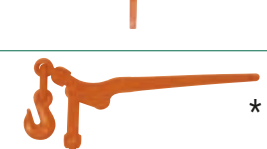
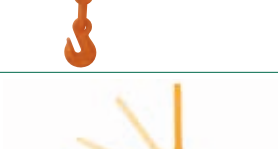

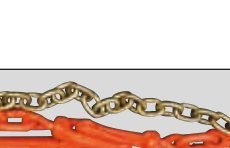

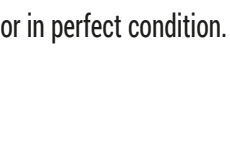
Load Binders

Code	Product	Chain Size in.	Capacity lbs.	Weight lbs.	
55005	BX 270 Style	3/16 (G30)	375	1.0	
55006	BX 271 Style	1/4 (G30 - G70) 5/16 (G30)	2,600	3.5	 *
55007	BX 320 Style	5/16 (G30 - G70) 3/8 (G43)	5,400	7.0	
55008	BX 400 Style	3/8 (G43 - G70) 1/2 (G43)	9,200	10.5	
55009	BX 600 Style	5/16 (G43 - G70) 3/8 (G43)	5,400	10.25	 *
55010	BX 800 Style	3/8 (G43 - G70) 1/2 (G43)	9,200	14.0	
55012	–	5/16 (G70) 3/8 (G43)	5,400	15	
55014	Ratchet type	1/4 (G43 - G70) 5/16 (G30)	2,600	3.85	 *
55015	Ratchet type	5/16 (G43 - G70) 3/8 (G43)	5,400	10.8	
55016	Ratchet type	3/8 (G43 - G70) 1/2 (G43)	9,200	12.75	
55017	Ratchet type	1/2 (G43 - G70) 5/8 (G43)	13,000	14.55	
LB150-012	Lever type	1/2 (G43 - G70) 5/8 (G43)	11,000	20	 *
QBR-516038	–	5/16 (G70 - G80) 3/8 (G70 - G80)	7,100	11.5	
QBR-038012	–	3/8 (G70 - G80) 1/2 (G70 - G80)	12,000	14	
QBR-012058	–	1/2 (G70 - G80) 5/8 (G70 - G80)	18,100	18.5	

*Forged steel, quenched and tempered. Stamped with Working Load Limit, size and matching chain grade.

Not intended for overhead lifting

Load Binder Locks

Code	Dimensions		Weight lbs.
	Length in.	Width in.	
BL12017	4.25	1.85	0.40

Designed for: 55005, 55006, 55007, 55008, 55009, 55010, LB150-012



 **WARNING:** The maximum loads shown are applicable only for new products or in perfect condition.

 Do not exceed maximum rated capacities.



Tie Down Chains - Grade 70 – yellow chromate

Code Bulk	Code Packaged	Diameter in.	Grade	Length ft.	Working Load Limits lbs.	Weight / each lbs.
SGG70516010-00	56017	5/16	70	10	4,700	10
SGG70516012-00	56018	5/16	70	12	4,700	12
SGG70516014-00	56004	5/16	70	14	4,700	14
SGG70516016-00	56029	5/16	70	16	4,700	16
SGG70516020-00	56032	5/16	70	20	4,700	20
SGG70516025-00	56022	5/16	70	25	4,700	25
SGG70038010-00	56021	3/8	70	10	6,600	15
SGG70038012-00	56024	3/8	70	12	6,600	18
SGG70038014-00	56025	3/8	70	14	6,600	21
SGG70038016-00	56030	3/8	70	16	6,600	24
SGG70038020-00	56005	3/8	70	20	6,600	30
SGG70038025-00	-	3/8	70	25	6,600	37
SGG70012010-00	-	1/2	70	10	11,300	23
SGG70012012-00	-	1/2	70	12	11,300	28
SGG70012014-00	-	1/2	70	14	11,300	32
SGG70012016-00	-	1/2	70	16	11,300	37
SGG70012020-00	-	1/2	70	20	11,300	46
SGG70012025-00	-	1/2	70	25	11,300	58

Safety Factor 4:1

Not intended for overhead lifting



Grade 70 “Transport” Chain -yellow chromate carbon steel

Grade 70 chain is extremely strong and resistant to wear. It is mainly used for transport tiedowns, towing, lumbering and other similar tasks. Meet NACM standard.

Yellow Chromate

Drum		
Code	Diameter in.	Pack ft.
53040	1/4	400
53041	5/16	275
53042	3/8	200
53043	1/2	100
53047	1/2	200
Pail		
Code	Diameter in.	Pack ft.
52030	1/4	65
52031	5/16	50
52032	3/8	45
52033	1/2	25

Specifications

Diameter in.	Inside Dimensions in.		Working Load Limits lbs.	Weight / 100 ft. lbs.
	A	B		
1/4	1.22	.51	3,150	71
5/16	1.28	.53	4,700	102
3/8	1.36	.57	6,600	143
1/2	1.77	.75	11,300	234

Safety Factor 4:1

Not intended for overhead lifting

Do not use for overhead lifting

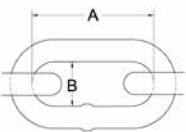



Tie Down Chains - Grade 43 – self-colored

Code Bulk	Code Packaged	Diameter in.	Grade	Length ft.	Working Load Limits lbs.	Weight / each lbs.
SGG40516010-00	56055	5/16	43	10	3,900	10
SGG40516012-00	56058	5/16	43	12	3,900	12
SGG40516014-00	56061	5/16	43	14	3,900	14
SGG40516016-00	56064	5/16	43	16	3,900	16
SGG40516020-00	56067	5/16	43	20	3,900	20
SGG40516025-00	56070	5/16	43	25	3,900	25
SGG40038010-00	56056	3/8	43	10	5,400	14
SGG40038012-00	56059	3/8	43	12	5,400	17
SGG40038014-00	56062	3/8	43	14	5,400	20
SGG40038016-00	56065	3/8	43	16	5,400	22
SGG40038020-00	56068	3/8	43	20	5,400	28
SGG40038025-00	–	3/8	43	25	5,400	35
SGG40012010-00	–	1/2	43	10	9,200	23
SGG40012012-00	–	1/2	43	12	9,200	28
SGG40012014-00	–	1/2	43	14	9,200	32
SGG40012016-00	–	1/2	43	16	9,200	37
SGG40012020-00	–	1/2	43	20	9,200	46

Safety factor : 3:1

Not intended for overhead lifting



Agricultural Safety Chains for Towed Machines - Grade 70

Code Bulk	Code Packaged	Chain Size in.	Length ft.	Tow Capacity lbs.	Weight / each lbs.
ASC-01405	56011	1/4	5	10,000	5.5
ASC-01406	56013	1/4	6	10,000	5.5
ASC-51605	56012	5/16	5	16,100	8.5
ASC-51606	56014	5/16	6	16,100	8.5
ASC-03805	56009	3/8	5	20,000	11.5
ASC-03806	56015	3/8	6	20,000	11.5
ASC-01205	56010	1/2	5	40,000	18.5
ASC-01206	56016	1/2	6	40,000	19.5

Custom sizes available on request.

Not intended for overhead lifting



Tow Chains - Grade 70

Code Bulk	Code Packaged	Chain Size in.	Length ft.	Working Load Limits lbs.	Weight / each lbs.
SGS70516006-00	–	5/16	6	4,300	7.5
SGS70516010-00	–	5/16	10	4,300	11.5
SGS70516014-00	56115	5/16	14	4,300	16.5
SGS70038004-00	–	3/8	4	5,250	7
SGS70038006-00	56117	3/8	6	5,250	11
SGS70038008-00	56118	3/8	8	5,250	13.5
SGS70038010-00	56119	3/8	10	5,250	16.5
SGS70038012-00	–	3/8	12	5,250	19
SGS70038016-00	56116	3/8	16	5,250	25
SGS70012012-00	–	1/2	12	9,000	31
SGS70012016-00	–	1/2	16	9,000	44

Safety factor : 4:1

Not intended for overhead lifting



Logging Tie-Down assembly (Tagged)

Code	Material	Chain	Hook	Working Load Limits lbs.	Weight / each lbs.
CCTD-01429	Steel Cable 7 x 19 Galv., 1/4" x 29'	GR. 70 1/4" x 1'	CGH70-516	2,333	4.698
CCTD-01429UHMWPE	Cord Dynasteel 1/4" x 29'	GR. 70 1/4" x 1'	CGH70-516	2,460	2

Safety factor : 3:1

Not intended for overhead lifting

Other combinations of cables, chain and hook available upon request.

BEN-MOR Hooked on Service





Clevis Grab Hooks (Gr. 70, gold chromate, forged alloy steel quenched and tempered)

Code	For Chain Diameter in.	Working Load Limits lbs.	Weight / each lbs.	Dimensions in.						
				B	C	E	F	H	L	T
CGH70-014	1/4	3,150	0.38	.32	1.81	3.05	1.64	.34	.31	.47
CGH70-516	5/16	4,700	0.70	.43	2.12	3.66	2.02	.44	.38	.59
CGH70-038	3/8	6,600	1.04	.48	2.53	4.42	2.41	.50	.44	.72
CGH70-012	1/2	11,300	2.06	.57	3.56	5.72	3.19	.66	.63	.78

Safety Factor 4:1

Not intended for overhead lifting

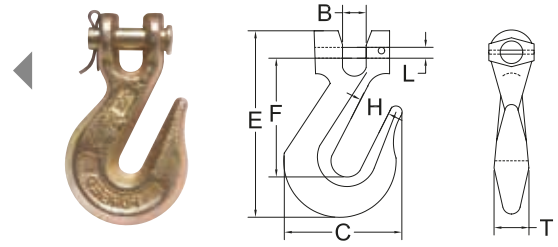

Clevis Grab Hooks with latch (Gr. 70, gold chromate, forged alloy steel quenched and tempered)

Code	For Chain Diameter in.	Working Load Limits lbs.	Weight / each lbs.	Dimensions in.				
				B	F	H	I	L
CGH70L-014	1/4	3,150	0.64	0.354	1.970	0.394	0.394	0.378
CGH70L-516	5/16	4,700	0.96	0.394	2.260	0.433	0.492	0.433
CGH70L-038	3/8	6,600	1.34	0.472	2.630	0.500	0.413	0.472
CGH70L-012	1/2	11,300	2.75	0.752	3.189	0.661	0.701	0.630

Safety Factor 4:1

Not intended for overhead lifting

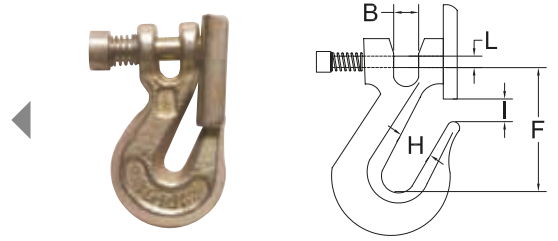

Clevis Slip Hooks (Gr. 70, gold chromate, forged alloy steel quenched and tempered)

Code without latch	Code with latch	For Chain Diameter in.	Working Load Limits lbs.	Weight / each lbs.	Dimensions in.						
					B	C	E	F	H	L	T
CSH70-014	CSH70L-014	1/4	2,750	0.50	.32	2.75	3.95	2.58	.94	.38	.50
CSH70-516	CSH70L-516	5/16	4,300	0.75	.43	3.06	4.52	2.87	1.06	.44	.56
CSH70-038	CSH70L-038	3/8	5,250	1.13	.45	3.63	5.15	3.25	1.31	.47	.66
CSH70-012	CSH70L-012	1/2	9,000	2.75	.57	4.81	6.53	4.00	1.69	.63	.91

Safety Factor 4:1

Not intended for overhead lifting

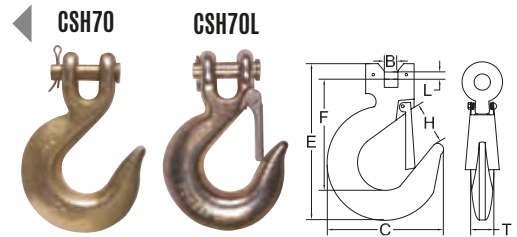

Twin Clevis Chain Midlink (Gr. 70 gold chromate, body carbon steel heat treated, pin alloy)

Code	For Chain Diameter in.	Working Load Limits lbs.	Weight / each lbs.	Dimensions in.			QTY CTN
				A	B	C	
S249-516BM	5/16	4,700	0.32	3/8	7/16	2.50	6
S249-038BM	3/8	6,600	0.44	7/16	1/2	2.81	6
S249-012BM	1/2	11,250	1.00	9/16	5/8	3.62	6

Safety Factor 4:1

Not intended for overhead lifting

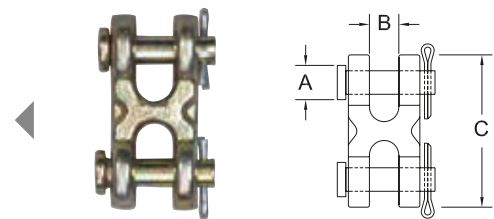

Safety Latch Kit (Gr. 70, for clevis slip hook)

Code	For Chain Diameter in.	Weight / each lbs.
LATCHGR701/4BM	1/4	0.01
LATCHGR705/16BM	5/16	0.02
LATCHGR703/8BM	3/8	0.02
LATCHGR707/16BM	7/16	0.39
LATCHGR701/2BM	1/2	0.39

Not intended for overhead lifting

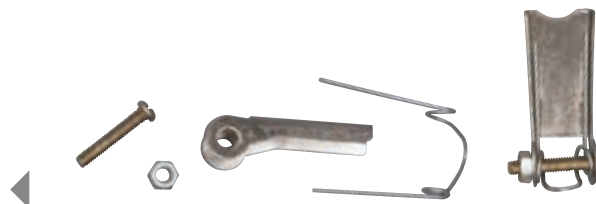



Roll Off Cables, 6x26

Diameter in.	Breaking Strength lbs.	TYPE	Length ft.		
			50	75	100
5/8	39,000	Swivel hook	ROCSH-058050	ROCSH-058075	ROCSH-058100
3/4	56,000	Swivel hook	ROCSH-034050	ROCSH-034075	ROCSH-034100
7/8	76,000	Swivel hook	ROCSH-078050	ROCSH-078075	ROCSH-078100
1	98,000	Swivel hook	ROCSH-001050	ROCSH-001075	ROCSH-001100
5/8	39,000	Thimble	ROCTH-058050	ROCTH-058075	ROCTH-058100
3/4	56,000	Thimble	ROCTH-034050	ROCTH-034075	ROCTH-034100
7/8	76,000	Thimble	ROCTH-078050	ROCTH-078075	ROCTH-078100
1	98,000	Thimble	ROCTH-001050	ROCTH-001075	ROCTH-001100
5/8	39,000	Button	ROCB-058050	ROCB-058075	ROCB-058100
3/4	56,000	Button	ROCB-034050	ROCB-034075	ROCB-034100
7/8	76,000	Button	ROCB-078050	ROCB-078075	ROCB-078100
1	98,000	Button	ROCB-001050	ROCB-001075	ROCB-001100



Safety factor : 3:1

Not intended for overhead lifting

Roll Off Cables, 6x36

Diameter in.	Breaking Strength lbs.	TYPE	Length ft.		
			50	75	100
5/8	39,000	Swivel hook	ROCSH-058050636	ROCSH-058075636	ROCSH-058100636
3/4	56,000	Swivel hook	ROCSH-034050636	ROCSH-034075636	ROCSH-034100636
7/8	76,000	Swivel hook	ROCSH-078050636	ROCSH-078075636	ROCSH-078100636
1	98,000	Swivel hook	ROCSH-001050636	ROCSH-001075636	ROCSH-001100636
5/8	39,000	Thimble	ROCTH-058050636	ROCTH-058075636	ROCTH-058100636
3/4	56,000	Thimble	ROCTH-034050636	ROCTH-034075636	ROCTH-034100636
7/8	76,000	Thimble	ROCTH-078050636	ROCTH-078075636	ROCTH-078100636
1	98,000	Thimble	ROCTH-001050636	ROCTH-001075636	ROCTH-001100636
5/8	39,000	Button	ROCB-058050636	ROCB-058075636	ROCB-058100636
3/4	56,000	Button	ROCB-034050636	ROCB-034075636	ROCB-034100636
7/8	76,000	Button	ROCB-078050636	ROCB-078075636	ROCB-078100636
1	98,000	Button	ROCB-001050636	ROCB-001075636	ROCB-001100636



Safety factor : 3:1

Not intended for overhead lifting

Winch Cables



Steel Core

Code	Diameter in.	Breaking Strength lbs.	Hook Capacity Ton	Length ft.											
				50	60	65	70	75	80	85	90	95	100	125	
WCWR-516_ _ _	5/16	10,000	1	050	060	065	070	075	080	085	090	095	100	125	
WCWR-038_ _ _	3/8	14,000	2	050	060	065	070	075	080	085	090	095	100	125	
WCWR-716_ _ _	7/16	19,000	3	050	060	065	070	075	080	085	090	095	100	125	
WCWR-012_ _ _	1/2	25,000	3	050	060	065	070	075	080	085	090	095	100	125	
WCWR-916_ _ _	9/16	32,000	4.5	050	060	065	070	075	080	085	090	095	100	125	
WCWR-058_ _ _	5/8	39,000	4.5	050	060	065	070	075	080	085	090	095	100	125	
WCWR-034_ _ _	3/4	56,000	7	050	060	065	070	075	080	085	090	095	100	125	

Safety factor : 3:1

Not intended for overhead lifting

Example for item code : WCWR-516050 (Winch Cable Wire Rope 5/16 X 50 ft.)

Fiber Core

Code	Diameter in.	Breaking Strength lbs.	Hook Capacity Ton	Length ft.											
				50	60	65	70	75	80	85	90	95	100	125	
WCWR-516_ _ _FC	5/16	7,500	1	050	060	065	070	075	080	085	090	095	100	125	
WCWR-038_ _ _FC	3/8	11,000	2	050	060	065	070	075	080	085	090	095	100	125	
WCWR-716_ _ _FC	7/16	15,000	3	050	060	065	070	075	080	085	090	095	100	125	
WCWR-012_ _ _FC	1/2	19,500	3	050	060	065	070	075	080	085	090	095	100	125	
WCWR-916_ _ _FC	9/16	25,000	4.5	050	060	065	070	075	080	085	090	095	100	125	
WCWR-058_ _ _FC	5/8	31,000	4.5	050	060	065	070	075	080	085	090	095	100	125	
WCWR-034_ _ _FC	3/4	44,000	7	050	060	065	070	075	080	085	090	095	100	125	

Safety factor : 3:1

Not intended for overhead lifting

Example for item code: WCWR-516050FC (Winch Cable Wire Rope Fiber Core 5/16 X 50 ft.)

**Other constructions available upon request. **Other lengths available upon request.



Snap Hook

Code	Hook Type	Material width in.	Weight / lbs.	Dimensions			
				A	B	C	D
3010250	Flat	1	0.2	1.06	3.78	0.47	0.14
3020254	Flat	2 (BS 10,000 lbs.)	0.6	2.00	4.76	0.98	0.24
3020255	Flat long	2 (BS 10,000 lbs.)	0.7	2.00	6.00	1.01	0.22

Not intended for overhead lifting

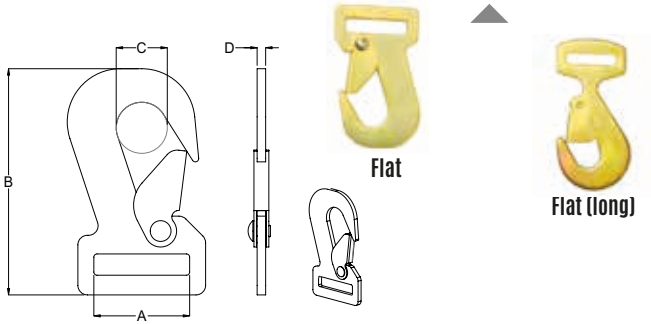

Vinyl "S" Hook

Code	Material width in.	Weight / lbs.
3010330	1 (BS 1,200 lb)	0.3

Not intended for overhead lifting



J-Hooks

Code	Material width in.	Weight / lbs.
EJH-8	8	4.0
CJH-8	8	4.0

Not intended for overhead lifting

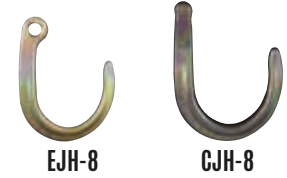

Flat Hooks

Code	Material width in.	Weight / lbs.	Dimensions			
			A	B	C	D
CP2	2	0.7	3.580	2.010	0.180	0.790
CP4	4	2.0	3.820	2.720	0.200	0.590

Not intended for overhead lifting

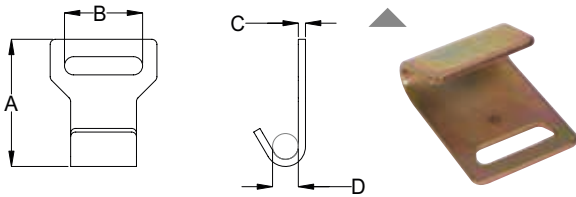

Chain Assembly

Code	Material width in.	Weight / lbs.
TCC2	2	2.3
TCC3	3	3.6
TCC4	4	4.2

Not intended for overhead lifting



Narrow Wire Hooks

Code	Material width in.	Weight / lbs.	Dimensions			
			A	B	C	D
CF1	1	0.10	1.06	2.36	0.28	0.79
CF1-SHORT	1	0.10	1.1	1.85	0.24	0.43
CF1-LONG	1	0.18	1.06	3.14	0.313	0.54
CF2	2	0.6	2.000	3.250	0.500	0.668
CF3	3	1.6	3.000	3.675	0.630	0.905

Not intended for overhead lifting

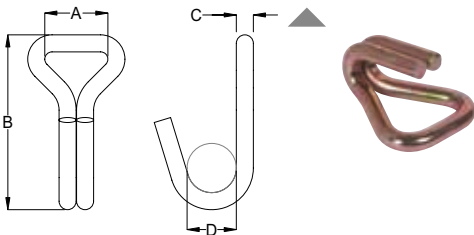

Auto Carrier Hooks

Code	Description	Weight / lbs.
CH	Cluster Hook	4.0
JH	J-Hooks	4.0
J&T	J & T Combo	0.5
RR-3	1/2" X 4" Round Ring	0.5
TH	T-Hook	0.5

Not intended for overhead lifting

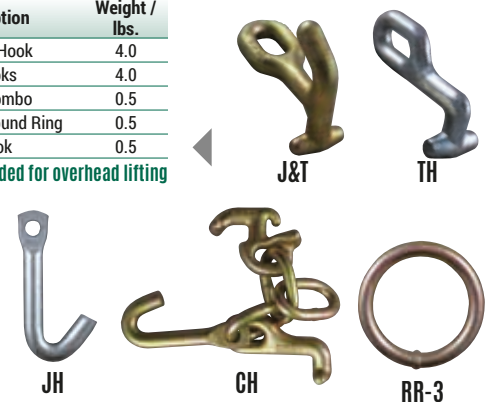



Tie-Down Accessories

Delta Rings

Code	Material width in.	Weight / lbs.	Dimensions					
			A	B	C	D	E	F
DR2	2	0.2	1.800	0.775	2.085	0.570	0.195	3.200
DR3	3	0.8	2.340	0.896	3.075	0.570	0.565	3.815
DR4	4	5.0	No Stock					

Not intended for overhead lifting

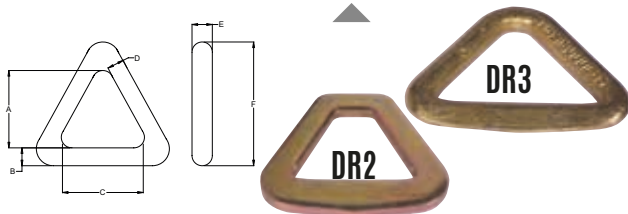

Corner Caps

Code	Width in.	Weight / lbs.
MCC2	1 3/4 - 2	-
MCC4	2 - 4	-
PCC	2 - 4	0.2

Not intended for overhead lifting



Ratchet Buckles

Code	Material width in.	Weight / lbs.	Dimensions		
			A	B	C
CB-001	1	0.13	1.024	0.590	1.968
CB-002	2	0.5	2.13	1.38	2.91

Not intended for overhead lifting



Code	Material width in.	Weight / lbs.	Dimensions			
			A	B	C	D
RAT1	1	1.0	1.18	-	6.93	2.2
RAT2L	1 3/4	2.5	2.13	2.36	7.56	3.9
RAT2S	2	1.5	2.13	2.44	6.42	2.99
RAT3L	3	7.0	2.99	3.35	12.58	4.33
RAT4L	4	8.0	4.09	3.35	12.68	5.31

Not intended for overhead lifting

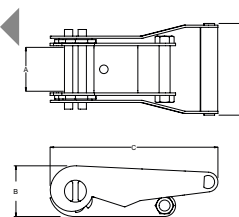

"E" Fitting

Code	Material width in.	Weight / lbs.
3040900	2 (BS 4,500 lbs)	0.2
ETR-2	2 (BS 2,100 lbs)	0.4

Not intended for overhead lifting



Rubber Straps w/ "S" Hooks

Code	Width in.	Weight / lbs.
TC9	9	0.2
TC21	21	0.3
TC31	31	0.4
TC41	41	0.5

Not intended for overhead lifting



Sliding Bars

Code	Width in.	Weight / lbs.
RAIL6	72	35.0

Not intended for overhead lifting



Side Winches

Code	Material width in.	Weight / lbs.	Dimensions			
			A	B	C	D
TRS2	2	3.5	4.90	2.08	4.00	2.94
TRS5	5	9.0	8.07	4.86	6.86	3.92

Not intended for overhead lifting



Aluminum E-Tracks

Code	Length ft	Weight / lbs.
6017A	10	4.0

Not intended for overhead lifting



Winch Bars

Code	Width in.	Weight / lbs.
BAR	30	5.0
BARCOMB	40	4.0

Not intended for overhead lifting





Forestry chokers

Code Type 3 (buttons)	Code Chain Type	Diameter x length in. x ft.	Minimum Breaking Strength lbs.
SFE3-716005	SFEC-716005	7/16 x 5	17,200
SFE3-716512	SFEC-716512	7/16 x 5 1/2	17,200
SFE3-716006	SFEC-716006	7/16 x 6	17,200
SFE3-716612	SFEC-716612	7/16 x 6 1/2	17,200
SFE3-716007	SFEC-716007	7/16 x 7	17,200
SFE3-716008	SFEC-716008	7/16 x 8	17,200
SFE3-012006	SFEC-012006	1/2 x 6	23,600
SFE3-012612	SFEC-012612	1/2 x 6 1/2	23,600
SFE3-012007	SFEC-012007	1/2 x 7	23,600
SFE3-012008	SFEC-012008	1/2 x 8	23,600
SFE3-012009	SFEC-012009	1/2 x 9	23,600
SFE3-012010	SFEC-012010	1/2 x 10	23,600
SFE3-916010	SFEC-916010	9/16 x 10	28,600
SFE3-916011	SFEC-916011	9/16 x 11	28,600
SFE3-916012	SFEC-916012	9/16 x 12	28,600
SFE3-916013	SFEC-916013	9/16 x 13	28,600
SFE3-916014	SFEC-916014	9/16 x 14	28,600
SFE3-916015	SFEC-916015	9/16 x 15	28,600

Not intended for overhead lifting



Type 3 Buttons

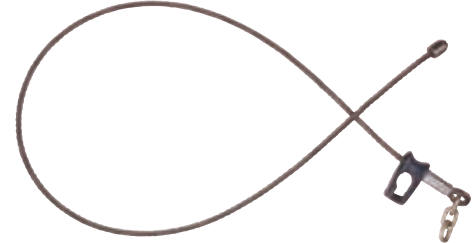

Chain Type

Extensions (type 2 buttons)

Code	Diameter x length in.	Minimum Breaking Strength lbs.
SFE2-716112	7/16 x 18	17,200
SFE2-716002	7/16 x 24	17,200
SFE2-012112	1/2 x 18	23,600
SFE2-012002	1/2 x 24	23,600
SFE2-916112	9/16 x 18	28,600
SFE2-916002	9/16 x 24	28,600

Not intended for overhead lifting



Type 6
Also available



Main Lines with Swaged button

Swaged Cable

Code	Diameter x length in. x ft.	Minimum Breaking Strength lbs.	Weight / ft. approx. lbs.
SFCPB-012	1/2 x 100	31,400	0.67
SFCPB-916	9/16 x 100	38,900	0.80
SFCPB-058	5/8 x 100	46,400	0.96
SFCPB-1116	11/16 x 100	54,400	1.20
SFCPB-034	3/4 x 100	68,800	1.55

Any length available upon request.

Super-Swaged Cable

Code	Diameter x length in. x ft.	Minimum Breaking Strength lbs.	Weight / ft. approx. lbs.
SFCPB-012S	1/2 x 100	33,600	0.67
SFCPB-916S	9/16 x 100	41,000	0.80
SFCPB-058S	5/8 x 100	54,400	0.96
SFCPB-1116S	11/16 x 100	67,400	1.20
SFCPB-034S	3/4 x 100	72,200	1.55

Not intended for overhead lifting



Logging Chain

Code	Diameter in.	Grade	Finish	Length ft.	Working Load Limit lbs.	Weight / each lbs.
56001	1/4	30	Self colored	14	1,100	8
56002	5/16	30	Self colored	14	1,900	12
56003	3/8	30	Self colored	14	2,650	17
56006	1/2	30	Self colored	14	4,500	33

Safety factor : 4:1

Not intended for overhead lifting



BEN-MOR Hooked on Service



Sliding Hooks for chokers

Code	Description	For Chokers Diameter in.
SFMIC	MICRO	5/16 – 5/8
SFMID	MIDGET	5/16 – 5/8
SFBAN	BANTAM	3/8 – 5/8

Not intended for overhead lifting



Rings for Main-lines

Code	Description
SFMLR-TH	« TWITCH-HOOK »
SFMLR-E	With reversed eye
SFGS-516	Spiral pin – 5/16 x 2

Not intended for overhead lifting



Buttons

Code	Description	For Chokers Diameter in.
SFBC-XXX	3/8, 7/16, 1/2, 9/16, 5/8 Taper sleeves	3/8, 7/16, 1/2, 9/16, 5/8
SFBP-XXX	3/8, 7/16, 1/2, 9/16, 5/8 Straight wall	3/8, 7/16, 1/2, 9/16, 5/8

Not intended for overhead lifting



Choker Sliding Hooks (forged carbon steel, quenched and tempered)

Code without latch	For cable diameter in.	Eye diameter in.	Throat opening in.	Weight / ft. approx. lbs.
A350L-038012BM	1/2	3/4	25/32	1.25
A350L-058BM	5/8	7/8	15/16	3.10
A350L-034BM	3/4	1	1 5/32	5.17



6 X 26 Super-swaged

Code	Diameter in.	Minimum Breaking Strength lbs.	Weight per 100 ft. lbs.
038626BSS	3/8	20,400	35
716626BSS	7/16	26,000	46
012626BSS	1/2	34,800	72
916626BSS	9/16	43,800	87
058626BSS	5/8	54,000	104
1116626BSS	11/16	65,000	122
034626BSS	3/4	77,000	185
078626BSS	7/8	104,000	209
001626BSS	1	133,000	244

8 X 36 Steel Core (Natural) EIPS

Code	Diameter in.	Minimum Breaking Strength lbs.	Weight per 100 ft. lbs.
058836B	5/8	36,200	67

6 X 26 Swaged

Code	Diameter in.	Minimum Breaking Strength lbs.	Weight per 100 ft. lbs.
038626BS	3/8	18,500	35
716626BS	7/16	24,300	46
012626BS	1/2	31,800	59
916626BS	9/16	40,000	72
058626BS	5/8	49,000	87
1116626BS	11/16	59,000	104
034626BS	3/4	70,000	122
078626BS	7/8	95,000	185
001626BS	1	123,000	209

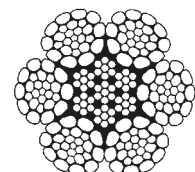

6 x WS(26) IWRC



The Tire Chain is Ben-Mor Winnipeg speciality. For further information, please contact the Winnipeg team at 1-800-689-8744.

Tractor Chains (DUO Grip Tractor Chains)

Features H-pattern cross chains wich keep the chain on top of the tire 3/8 case hardened cross chain
Sets are available in domestic or import Bulk continuous DUO Grip made in the U.S.A

For off-road use only
Code: TC-TRAC



Snow Blower & Garden Tractor Chains

Code: TC-SBGT



Forklift Chains

Square and twist link alloy cross chains.

Two-link spacing available upon request



SQUARE LINK FOR FORKLIFT CHAINS



All Terrain Vehicle Tire Chain

Code: TC-ATVS

		PRODUCT CODE		
TC-	TRAC	TW-	2108FL	2
Tire chain	Application	Chain type	Code ID	Nb link spacing
ATVS: All terrain vehicle FORK: Fork lift GRAD: Grader HEAV: Heavy equipment PASS: Passenger SBGT: Snow Blower / Garden Tractor SKID: skid steer / bobcat tire TRAC: Tractor & equipment TRUC: Truck		TW: twist link SQ: Square chain TR: Trygg chain NL: Net link bdl stud UL: U lug chain VB: V bar chain WS: with stud chain SG: Super Grizzly S2: Super 2000		Except: TRS... (inches)



Reinforced Single Truck Chains

(Light Truck and SUV, Heavy Truck & Bus)

Reinforced cross chain for increased traction and wear
Recommended for off-road use
Code: TC-TRUC



Reinforced Dual-Triple Truck Chains

(Light Truck and SUV, Heavy Truck & Bus)

Reinforced cross chain for increased traction and wear Recommended
for off-road use
Code: TC-TRUC





Chain Repair Pliers

Code : CHPXL
Length : 33.5 in.

Code : CHPL
Length : 18 in.



Heavy equipment tightening tool

Replacement <<T>> Handles for Cam chains



Boomer with link

Code : BWL-08TRYGG, BWL-9.5TRYGG



Replacement cross chain hooks for Trygg chains

Code : CCHH-10TRYGG, CCHH-13TRYGG



CrossFit tensioners

Center screw pulls chains tight
Lock nuts prevent stripped threads
Includes 4 shackles
Sold perpiece 1/2 pair

Code : CFCT-TRYGG
Description : 25 - 29 rims
Weight kg/lbs : 3.5/7.7



Tightening tools for Trygg truck chains



Flat C-Hooks for side chain

Code : FCH-07
Length : 7-10 mm



Repair Connecting links with pin

Code : CLPIN-10TRYGG, CLPIN-13YGG, CLPIN-1619TRYGG, CLPIN-16TRYGG, CLPIN-19TRYGG



Replacement cross chains for Trygg





Trailer Safety Chains (class 1)

Code	Chain Diameter in.	Grade	Class	Length in.	Endings	Weight / ea. lbs.
56090	3/16	30	1	36	2 x "S" Hooks 3/8	0.9
56091	3/16	30	1	48	2 x "S" Hooks 3/8	1.2
56092	3/16	30	1	60	2 x "S" Hooks 3/8	1.5
56093	3/16	30	1	72	2 x "S" Hooks 3/8	1.7
56111	3/16	30	1	24	1 x "S" Hook 3/8	0.6
56095	3/16	30	1	30	1 x "S" Hook 3/8	0.7
56096	3/16	30	1	36	1 x "S" Hook 3/8	0.9

Not intended for overhead lifting



Trailer Safety Chains (class 2)

Code	Chain Diameter in.	Grade	Class	Length in.	Endings	Weight / ea. lbs.
56097	1/4	30	2	36	2 x "S" Hooks 7/16	1.6
56098	1/4	30	2	48	2 x "S" Hooks 7/16	2.1
56099	1/4	30	2	60	2 x "S" Hooks 7/16	2.0
56100	1/4	30	2	72	2 x "S" Hooks 7/16	3.1
56101	1/4	30	2	24	1 x "S" Hook 7/16	1.0
56102	1/4	30	2	30	1 x "S" Hook 7/16	1.3
56103	1/4	30	2	36	1 x "S" Hook 7/16	1.6

Not intended for overhead lifting



Others

Code	Chain Diameter in.	Grade	Class	Length in.	Endings	Weight / ea. lbs.
56113	5/16	30	N/D	40	1 x "S" Hook with latch	3.48
56114	3/8	30	N/D	41	1 x Hook with G43 latch	4.74

Not intended for overhead lifting

Tow Cables and Winch Cables

Code	Description
90300	Tow Cable 7/32, 7 x 19 GAC x 25'
90304	Tow Cable 7/32, 7 x 19 GAC x 50'
90301	Tow Cable 5/16, 7 x 19 GAC x 25'
ASY-WC-20R	Winch Cable 1/8, 7 x 7 GAC x 20'
ASY-WC-25	Winch Cable 3/16, 7 x 7 GAC x 25'
90305	Winch Cable 3/16, 7 x 19 GAC x 50'

Not intended for overhead lifting



E-Zee Lockouts™

High quality aluminum bar stock and 1/16» aircraft cable

Code	Length
EZLOCK-012	12"
EZLOCK-018	18"
EZLOCK-024	24"
EZLOCK-036	36"

Not intended for overhead lifting

Other dimensions available upon request.

3 Easy Steps

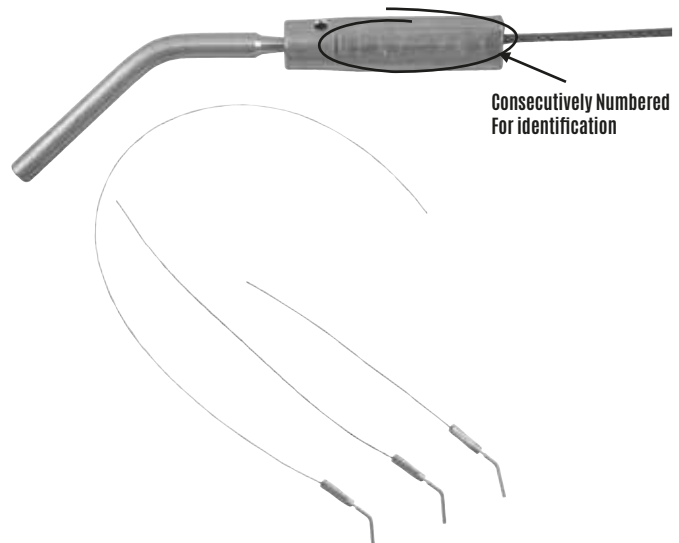



Many other models available in stock.

Whip Restraints, hose-hose type

Code	For Hose Diameter in.	Length in.	Diameter of Cable Used in.	Weight / ea. approx. lbs.
WR1822-15	1/2 - 1 1/4	15	1/8	0.16
WR1822-18	1/2 - 1 1/4	18	1/8	0.19
WR1822-20	1/2 - 1 1/4	20	1/8	0.21
WR1822-22	1/2 - 1 1/4	22	1/8	0.23
WR1422-24	1 1/2 - 3	24	1/4	0.91
WR1422-30	1 1/2 - 3	30	1/4	0.92
WR1422-36	1 1/2 - 3	36	1/4	1.22
WR1422-37.5	1 1/2 - 3	37 1/2	1/4	1.26
WR1422-48	1 1/2 - 3	48	1/4	1.50
WR3822-48	3 1/2 - 6	48	3/8	3.00

Any length available upon request.

Not intended for overhead lifting



Whip Restraints, hose-tool type

Code	For Hose Diameter in.	Length in.	Diameter of Cable Used in.	Weight / ea. approx. lbs.
WR18215	1/2 - 1 1/4	22	1/8	0.21
WR14215	1 1/2 - 3	37 1/2	1/4	1.22
WR1421	1 1/2 - 3	23	1/4	0.73
WR1821	1/2 - 1 1/4	13 1/2	1/8	0.15

Not intended for overhead lifting

Any length available upon request.

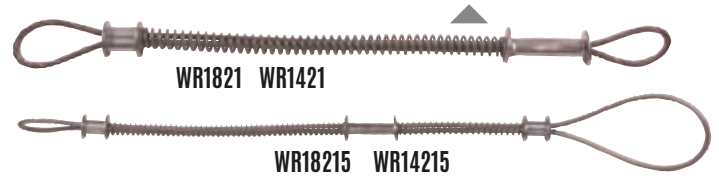

Whip Restraints, hose-tool type with snap hook

Code	For Hose Diameter in.	Length in.	Diameter of Cable Used in.	Weight / ea. approx. lbs.
WR1821-S	1/2 - 1 1/4	14	1/8	0.21

Not intended for overhead lifting

Any length available upon request.



Loop Wire Rope Concrete Anchors

Code	Cable	Working Load Limit TON	Weight / each lbs.	Dimensions in.	
				A	B
LWRCA-058	6 x 19 Galv., 5/8"	6	3.72	22	11
LWRCA-038	7 x 19 Galv., 3/8"	2	1.04	18 1/4	9

Wire rope concrete anchor custom made available.

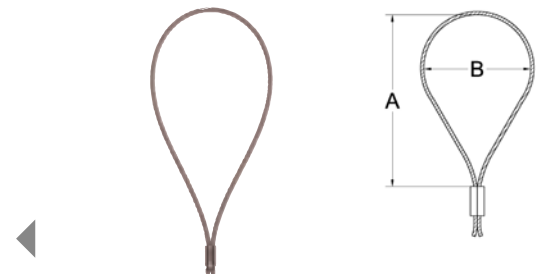

Oval Wire Rope Concrete Anchors (tagged)

Code	Cable	Rod in. x ft.	Working Load Limit TON	Weight / each lbs.	Dimensions in.	
					A	B
OWRA-058	6 x 19 Galv., 5/8"	1/8 x 9 1/4	6	3.72	16 3/4	9 1/4
OWRA-034	6 x 19 Galv., 3/4"	1/8 x 9 1/4	8	4.83	18 7/8	9 1/4
OWRA-078	6 x 19 Galv., 7/8"	3/16 x 11	12	8.35	23 1/4	11
OWRA-114	6 x 37 Galv., 1 1/4"	3/16 x 15 3/4	25	21.32	33 15/32	15 3/4

Wire rope concrete anchor custom made available.

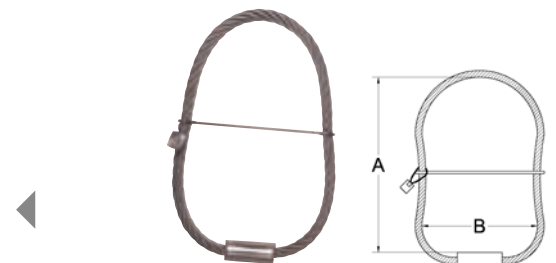

SUPPORTING OUR CUSTOMERS & THEIR STRUCTURES!

***Ben-Mor is a proud partner of
Fabric Building Manufacturers
all across North America.***

Products Available:

Sliding End Flaps Cables

Webbing

Ratchet Straps

Turnbuckles

Hooks

Cam Straps

Cable assemblies

Winches





Aircraft Cable

As per specifications RR-W-410F and ASTM A1023/A 1023M.

7 X 19 Hot Dip Galvanized

Code	Diameter in.	Minimum Breaking Strength lbs.	Weight per 100 ft. lbs.
316719G	3/16	4,200	6.5
516719G	5/16	9,800	17.3
038719G	3/8	14,400	24.3

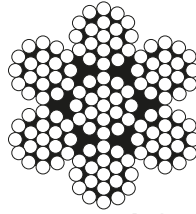

7 x 19
Hot Dip Galvanized

6 X 19 EIPS Steel Core

Diameter in.	Weight per 100 ft. lbs.	Steel Core	
		Galvanized	
		Code	Minimum Breaking Strength lbs.
1/2	46	012619GEIPS	24,000
5/8	72	058619GEIPS	37,000
3/4	104	034619GEIPS	53,000

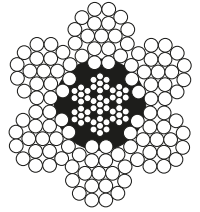

6 x 19
Steel Core

Miniature cable available on request (smaller than 1/32")

1" Ratchet Endless Strap

Code	End Hardware	Width in.	Length ft.	Working Load Limit lbs.
RSEN1-06	Ratchet Strap - Endless	1	8	1,100
RSEN1-08	Ratchet Strap - Endless	1	12	1,100
RSEN1-10	Ratchet Strap - Endless	1	16	1,100
RSEN1-12	Ratchet Strap - Endless	1	24	1,100

Custom sizes available.

Not intended for overhead lifting



2" Cambuckle Endless Strap

Code	End Hardware	Width in.	Length ft.	Working Load Limit lbs.
CSEN1-03	Cambuckle	1	3	360

Custom sizes available.

Not intended for overhead lifting



Cable in tube

Code	Diameter ID - OD
316716719GPWTUBE	3/16 - 7/16
014716719GPWTUBE	1/4 - 7/16

Stainless steel also available.

Not intended for overhead lifting



Side Winches

Code	Strap Width in.	Weight / lbs.	Dimensions			
			A	B	C	D
TRS2	2	3.5	4.90	2.08	4.00	2.94

Left or right winding available.

Not intended for overhead lifting

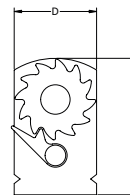
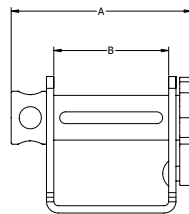

TRS2

2", 3" & 4" Ratchet straps

Code	End Hardware	Width in.	Length ft.	Working Load Limit lbs.	Tail end
RSTSH2-15SAT	Twist Snapp Hook	2	15	2200	18"

Custom sizes available.

Not intended for overhead lifting



RSTSH2

Pre-Cut Webbing

Code	Description
1134030	POLY WEB GREY 1-3/4X24' 10000LB
1134031	POLY WEB GREY 1-3/4X6' 10000LB
1134037	POLY WEB GREY 1-3/4X16' 10000LB

Not intended for overhead lifting



MORE THAN AN ANNIVERSARY, IT'S A SUCCESS STORY!

BEN-MOR CABLES

Ben-Mor Cable Inc.

Central Canada

4408, Trillium Street, Oshawa
16 Highway 10, Oshawa, Ontario
L1G 7Y1
Phone: (905) 773-0022
Fax: (905) 773-0033

Western Canada

618 Cambridge Street
Winnipeg, Manitoba
R3M 3J2
Phone: (204) 483-8120
Fax: (204) 483-8120

Eastern Canada

1111, Ave. J
2nd Floor, West
Montreal, Quebec
H3M 2V5
Phone: (514) 343-2880
Fax: (514) 343-2880

AIMING FOR THE FUTURE

BEN-MOR
Hooked on SERVICE

BEN-MOR
Industrial

BEN-MOR
Accessoires du SERVICE

BEN-MOR



BEN-MOR
Hooked on SERVICE

Ben-Mor is 30 years of strong and safe products: guarantees of confidence and quality for all our customers.

It is also a passionate and dedicated team, always aiming for excellence and customer satisfaction.

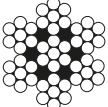

Bracing Cable (Galvanized)

	Code	Diameter in.	Construction	Length ft.	Safe Working Load lbs.
 7 x 7	SSBC-3641000	3/64	7X7	1,000	35
	SSBC-1160500	1/16	7X7	500	75
	SSBC-3320500	3/32	7X7	500	150
	SSBC-0180500	1/8	7X7	500	250
 7 x 19	SSBC-3160250	3/16	7X19	250	640
	SSBC-0140250	1/4	7X19	250	1,100

*Also available in stainless steel.

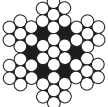

Cables with fittings

	Diameter in.	Construction	Safe Working Load lbs.
 7 x 7	3/64	7X7	35
	1/16	7X7	75
	3/32	7X7	150
	1/8	7X7	250

Not intended for overhead lifting



Sway Bracing Cable With Straight Eyelet



Sway Bracing Cable With 45° Eyelet



Looped Cable

Kwik-Locs

Code	Typical Applications	Cable diameter in.	Safe Working Load lbs.
SSKL050	Signs, Lighting, Gallery Displays	3/64	5 - 35
SSKL075	Signs, Lighting, Gallery Displays	1/16	10 - 75
SSKL100	Fluorescent Lights, Speakers, Busbar, Cable Trays	3/32	25 - 150
SSKL150	Heavy Cable Basket HID Lights	1/8	25 - 250
SSKL200	Sound Systems, Heavy Cable Trays	3/16	50 - 640
SSKL600	Services, Strud	1/4	50 - 1,100

Safety factor : 5:1

Not intended for overhead lifting

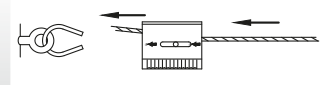

KL50 / KL75 / KL100 / KL150 / KL200 (Assembly Instructions)

- 

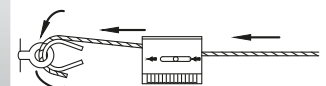
Pull adjustment pin back and pass wire through KWIK-LOC™ Failure to pull adjustment pin first may cause damage to serrated teeth and reduce holding capacity.
- 

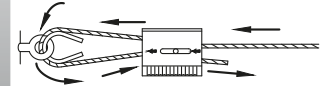
Loop wire through anchor.
- 

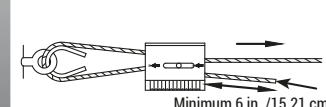
Pull adjustment pin back and pass wire back through KWIK-LOC™ Push through at least 6" of wire rope.
- 

Always confirm engagement of KWIK-LOC™ on wire before applying load by pushing the adjustment pin in the opposite direction of the arrows on the cable lock and then pulling the cable also in the opposite direction of the arrows on the cable lock.

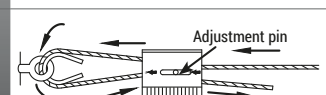
Minimum 6 in. /15.21 cm
- 

To adjust, take the load off and pull the tail slightly to disengage teeth, then release using adjustment pin.

Continental
Cable LLC

NORTH AMERICAN
MADE QUALITY.



AS 9100 ISO 9001

AS 9100 ISO 9001

On October 2, 2006, Ben-Mor Cables, Inc. acquired Continental Cable Company located in Hinsdale, New Hampshire, USA.

Continental Cable and its affiliates have been producing wire rope since 1948. The company has evolved into a leading manufacturer of custom wire rope and cable assemblies. Continental Cable expanded its product line to include an extensive stock of cable hardware with the acquisition of GBG Industries in 1989.

Continental Cable is an ISO 9001 :2015 and AS 9100D company which is essential when serving the aircraft industry. Also, Continental Cable is a qualified products list producer of MIL-DTL-83420 aircraft control cable as well as Federal Specification RR-W-410. With these qualifications, we are able to provide military and federal specification products for the aircraft and industrial markets.

The swaging, stranding, extrusion and machining capabilities of Continental Cable combined with the distinct service of Ben-Mor Cables make a perfect match. We look forward to providing the quality products and services you have come to expect.



MIL-DTL-83420

Continental Cable is an approved source for MIL-DTL-83420. Wire rope manufactured under this specification has been qualified by a test facility located in the continental United State or Canada. The specification MIL-DTL-83420 establishes all of the requirements for each size of wire rope for each type, composition, and construction.

The specific requirements refer to:

Steel composition

Tin and zinc coating composition

Lubricant

Construction

Wire properties

Preforming

Splicing and joining

Twist-off

Temperature range*

Wire flexibility

Stretch limits

Test load

Resistance to fluid

Color-coding identification

Breaking strength

Endurance

Ductility of steel

* The wire rope shall be capable of operation in wind, dust, fuel, oil spills, wash-down, and other aircraft environmental stresses and experiences within a -65°F to +250°F (-54°C to 121°C) temperature range.

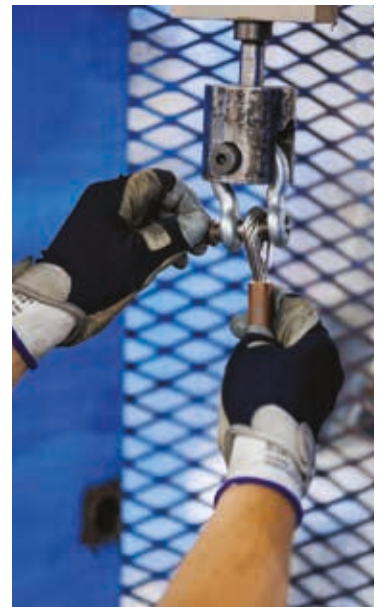

MIL-DTL-83420

We are qualified to manufacture wire rope & cable under the detailed specification MIL-DTL-83420 for all of the products listed.

Type 1 - Comp A - Galvanized

Code	Construction	Diameter in.	Breaking Strength lbs.	Weight per 100 feet lbs.
GML047N-MFGC	7 x 7	3/64	270	0.42
GML063N-MFGC	7 x 7	1/16	480	0.75
GML094N-MFGC	7 x 7	3/32	920	1.6
GML094P-MFGC	7 x 19	3/32	1,000	1.6
GML125P-MFGC	7 x 19	1/8	2,000	2.9
GML156P-MFGC	7 x 19	5/32	2,800	4.5
GML188P-MFGC	7 x 19	3/16	4,200	6.5
GML250P-MFGC	7 x 19	1/4	7,000	11

Type 1 - Comp B - Stainless Steel 302/304

Code	Construction	Diameter in.	Breaking Strength lbs.	Weight per 100 feet lbs.
SML047N-MFGS	7 x 7	3/64	270	0.42
SML063N-MFGS	7 x 7	1/16	480	0.75
SML063P-MFGS	7 x 19	1/16	480	0.75
SML094N-MFGS	7 x 7	3/32	920	1.6
SML094P-MFGS	7 x 19	3/32	920	1.6
SML125P-MFGS	7 x 19	1/8	1,760	2.9
SML156P-MFGS	7 x 19	5/32	2,400	4.5
SML188P-MFGS	7 x 19	3/16	3,700	6.5
SML219P-MFGS	7 x 19	7/32	5,000	8.6
SML250P-MFGS	7 x 19	1/4	6,400	11
SML375P-MFGS	7 x 19	3/8	12,000	24.3

Other size available upon request.

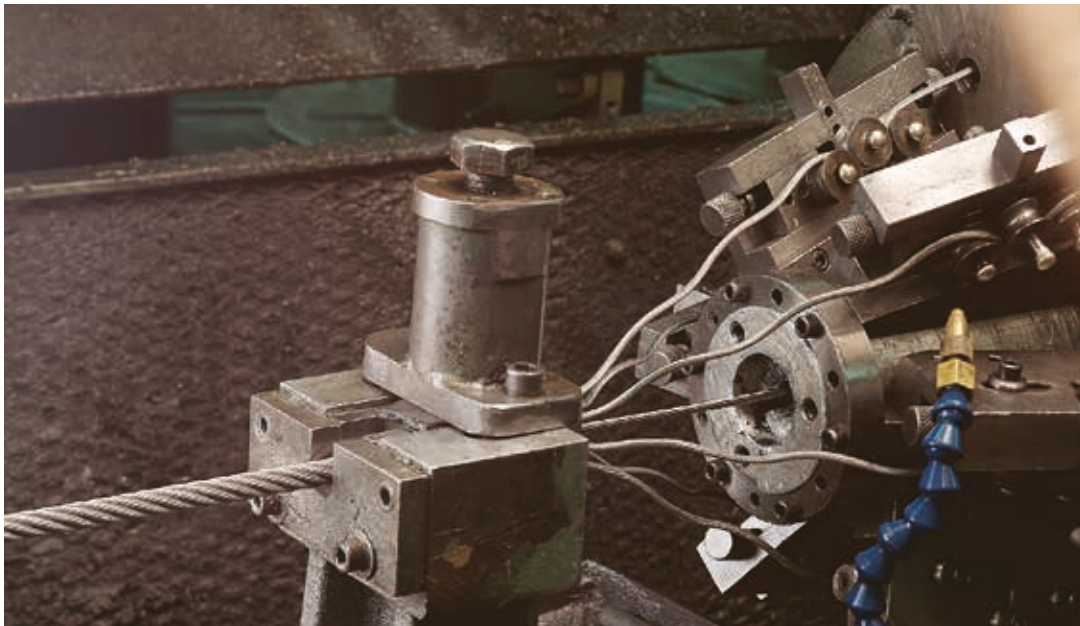

Threaded Aircraft Fittings MS21259 (Stainless Steel)

RH or LH Thread Code	For Cable Diameter in.	Weight ea. lbs.	Thread D NF-3A or UNF-3A	Dimensions in.					
				C	D Before swage	D After swage	E +.015 -.000 Before swage	E After swage	P
MS21259-2	1/16	0.0100	6-40	.188	.160	.138	2.473	2.65	1.045
MS21259-3	3/32	0.0225	10-32	.250	.218	.190	2.879	2.996	1.204
MS21259-4	1/8	0.0375	1/4-28	.313	.250	.219	3.333	3.589	1.376
MS21259-5	5/32	0.0475	1/4-28	.313	.297	.250	3.627	3.972	1.376
MS21259-6	3/16	0.0800	5/16-24	.375	.359	.313	4.002	4.170	1.458
MS21259-7	7/32	0.1200	3/8-24	.438	.427	.375	4.516	4.812	1.625
MS21259-8	1/4	0.1650	3/8-24	.500	.494	.438	4.937	5.236	1.750
MS21259-9	9/32	0.2650	7/16-20	.625	.563	.500	5.391	5.750	1.875
MS21259-10	5/16	0.3750	1/2-20	.688	.635	.563	5.844	6.266	2.000
MS21259-12	3/8	0.5000	9/16-18	.750	.703	.625	6.656	7.069	2.250
MS21259-14	7/16	0.6250	5/8-18	.812	.781	.688	7.437	7.910	2.500
MS21259-16	1/2	0.7500	5/8-18	.875	.844	.750	8.187	8.742	2.500

*Available on request: Left-hand thread.

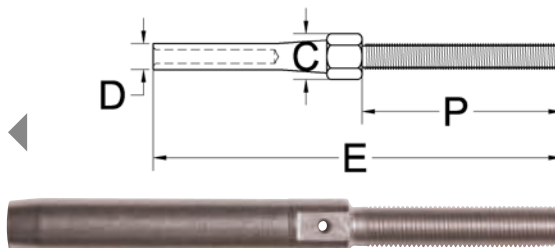

Threaded Aircraft Fittings MS21260 (Stainless Steel)

RH or LH Thread Code	For Cable Diameter in.	Weight ea. lbs.	Thread B NF-3A or UNF-3A	Dimensions in.							
				C	D Before swage	D After swage	E ±.063 Before swage	E After swage	N +.006 -.000	P ±.047	X After swage
MS21260-L-2 S-2	1/16	0.010 0.011	6-40	.188	.160	.138	3.491 2.616	3.669 2.794	.092	.375	1.319
MS21260-L-3 S-3	3/32	0.020 0.024	10-32	.250	.218	.190	3.738 2.863	3.855 2.980	.133	.500	1.581
MS21260-L-4 S-4	1/8	0.024 0.040	1/4-28	.313	.250	.219	4.020 3.145	4.276 3.401	.195	.563	1.863
MS21260-L-5 S-5	5/32	0.044 0.050	1/4-28	.313	.297	.250	4.314 3.439	4.659 3.784	.195	.625	2.157
MS21260-L-6 S-6	3/16	0.070 0.086	5/16-24	.375	.359	.313	4.612 3.737	4.780 3.905	.245	.750	2.455
MS21260-7	7/32	.130	3/8-24	.438	.427	.375	4.914	5.210	.306	.875	2.257
MS21260-8	1/4	.170	3/8-24	.500	.494	.438	5.218	5.517	.306	.875	3.061
MS21260-9	9/32	.22	7/16-20	.625	.563	.500	5.542	5.901	.361	1.000	3.385
MS21260-10	5/16	.35	1/2-20	.688	.635	.563	5.875	6.297	.406	1.000	3.718
MS21260-12	3/8	.50	9/16-18	.750	.703	.625	6.608	7.021	.476	1.125	4.281
MS21260-14	7/16	.75	5/8-18	.812	.781	.688	7.468	7.941	.538	1.250	4.812
MS21260-16	1/2	1.00	5/8-18	.875	.844	.750	8.718	9.273	.538	1.250	5.562

*Available on request: Left-hand thread.

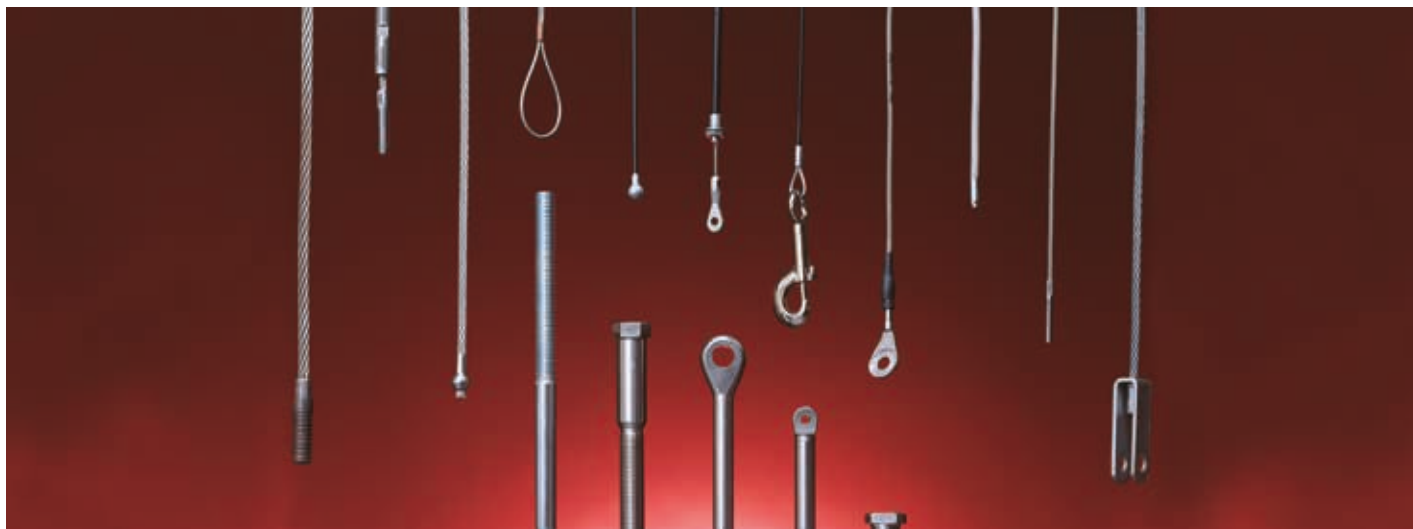
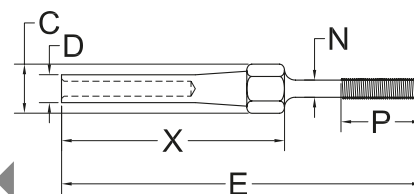

Aircraft Jaw Fitting MS20667 (Stainless Steel)

Code	For Cable Diameter in.	Weight ea. lbs.	Dimensions in.									
			A	C	D Before swage	D After swage	G		H ±.003	T +.010 -.005	X Before swage	X After swage
							Dia.	Tol.				
MS20667-2	1/16	0.01	.500	.344	.160	.138	.190	+0.002 -.000	.093	.218	1.572	1.750
MS20667-3	3/32	0.02	.670	.438	.218	.190	.190	+0.002 -.000	.108	.254	1.945	2.062
MS20667-4	1/8	0.03	.735	.547	.250	.219	.190	+0.002 -.000	.195	.383	2.352	2.608
MS20667-5	5/32	0.05	.800	.688	.297	.250	.250	+0.002 -.000	.202	.406	2.655	3.000
MS20667-6	3/16	0.09	.880	.781	.359	.313	.313	+0.002 -.000	.260	.543	3.071	3.239
MS20667-7	7/32	0.15	.970	.906	.427	.375	.313	+0.002 -.000	.296	.625	3.440	3.736
MS20667-8	1/4	0.20	1.070	.969	.494	.438	.375	+0.002 -.000	.313	.688	3.806	4.105
MS20667-9	9/32	0.30	1.170	1.156	.563	.500	.438	+0.002 -.000	.327	.719	4.120	4.479
MS20667-10	5/16	0.38	1.268	1.265	.635	.563	.438	+0.002 -.000	.348	.765	4.438	4.860
MS20667-12	3/8	0.57	1.525	1.500	.703	.625	.500	+0.005 -.000	.380	.830	5.333	5.746
MS20667-14	7/16	0.77	1.776	1.750	.781	.688	.562	+0.005 -.000	.380	.830	6.402	6.575
MS20667-16	1/2	1.62	1.903	1.875	.844	.750	.625	+0.005 -.000	.473	1.035	6.938	7.50

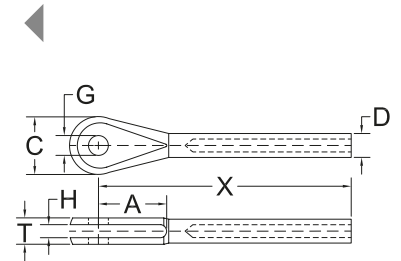

Aircraft Eye Fitting MS20668 (Stainless Steel)

Code	For Cable Diameter in.	Weight ea. lbs.	Dimensions in.									
			A ±.020	C	D Before swage	D After swage	G		T		X Before swage	X After swage
							Dia.	Tol.	Dia.	Tol.		
MS20668-2	1/16	0.01	.523	.359	.160	.138	.190	+0.002 -.000	.088	+0.000 -.005	1.631	1.809
MS20668-3	3/32	0.02	.707	.438	.218	.190	.190	+0.002 -.000	.103	+0.000 -.005	2.049	2.160
MS20668-4	1/8	0.03	.738	.500	.250	.219	.190	+0.002 -.000	.190	+0.000 -.005	2.337	2.593
MS20668-5	5/32	0.05	.831	.640	.297	.250	.250	+0.002 -.000	.197	+0.000 -.005	2.684	3.029
MS20668-6	3/16	0.09	.903	.781	.359	.313	.313	+0.002 -.000	.255	+0.000 -.005	3.019	3.187
MS20668-7	7/32	0.13	1.007	.813	.427	.375	.313	+0.002 -.000	.291	+0.000 -.005	3.382	3.678
MS20668-8	1/4	0.20	1.133	.968	.494	.438	.375	+0.002 -.000	.307	+0.000 -.005	3.763	4.062
MS20668-9	9/32	0.25	1.257	1.109	.563	.500	.438	+0.002 -.000	.322	+0.000 -.005	4.153	4.512
MS20668-10	5/16	0.40	1.373	1.218	.635	.563	.438	+0.002 -.000	.343	+0.000 -.005	4.546	4.969
MS20668-12	3/8	0.57	1.688	1.500	.703	.625	.500	+0.005 -.000	.375	+0.000 -.015	5.562	5.968
MS20668-14	7/16	0.79	1.968	1.750	.781	.688	.562	+0.005 -.000	.375	+0.000 -.015	6.398	6.867
MS20668-16	1/2	1.05	2.115	1.875	.844	.750	.625	+0.005 -.000	.468	+0.000 -.015	7.323	7.886

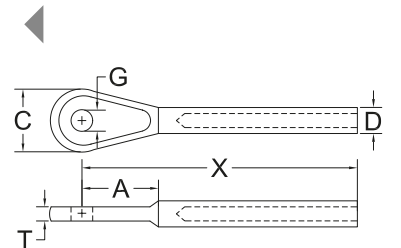

Ball Fittings (Stainless Steel)

Code	For Cable Diameter in.	*Minimum Breaking Strength lbs.	Weight / each lbs.	Dimensions in.						
				E Before swage		E After swage		T Before swage		
				Max.	Min.	Max.	Min.	Max.	Min.	
BA3-1	1/32	88	0.002	.211	.208	.188	.141	.137		
BA3-1.5	3/64	215	0.0019	.211	.208	.188	.141	.137		
BA3-2	1/16	385	0.0017	.211	.208	.188	.141	.137		
BA3-3	3/32	735	0.004	.288	.284	.250	.174	.170		
BA3-4	1/8	1,200	0.006	.355	.351	.313	.190	.184		
BA3-5	5/32	1,680	0.009	.429	.425	.375	.227	.222		
BA3-6	3/16	2,520	0.010	.498	.493	.438	.264	.259		

Not intended for overhead lifting

*Breaking Strength: Will break cable.

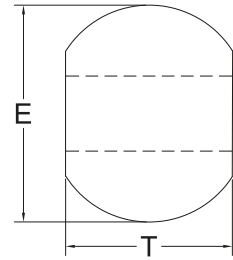

Shank Balls MS20664 (Stainless Steel)

Code	Cor. Res. Steel	Nominal Cable Diameter in.	Weight / each lbs.	Dimensions in.							
				C Before swage	C After swage	D Before swage	D After swage	E	I	Y Max. Rad.	Z After swage
MS20664-C2		1/16	.0019	.212	.190	.132	.112	.2685	.114	.014	.156
MS20664-C3		3/32	.005	.282	.253	.168	.143	.384	.152	.019	.234
MS20664-C4		1/8	.0075	.350	.315	.223	.190	.500	.1895	.023	.313
MS20664-C5		5/32	.010	.424	.379	.259	.222	.616	.2275	.028	.391
MS20664-C6		3/16	.015	.492	.442	.298	.255	.730	.2645	.033	.469
MS20664-C7		7/32	.025	.560	.505	.352	.302	.846	.3025	.038	.547
MS20664-C8		1/4	.030	.629	.567	.406	.348	.962	.3395	.042	.625
MS20664-C9		9/32	.050	.699	.632	.444	.382	1.078	.3775	.046	.750
MS20664-C10		5/16	.066	.768	.694	.480	.413	1.193	.4145	.046	.813

Not intended for overhead lifting

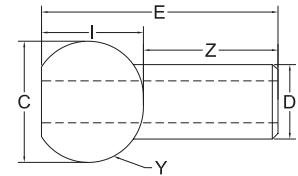

Double Shank Balls MS20663 (Stainless Steel)

Code	Cor. Res. Steel	Nominal Cable Diameter in.	Weight / each lbs.	Dimensions in.							
				C Before swage	C After swage	D Before swage	D After swage	E Before swage	E After swage	Y Max. Rad.	
MS20663-C2		1/16	.0016	.207	.190	.127	.112	.362	.390	.014	
MS20663-C3		3/32	.0032	.277	.253	.163	.143	.525	.578	.019	
MS20663-C4		1/8	.0094	.345	.315	.218	.190	.688	.765	.023	
MS20663-C5		5/32	.0125	.419	.379	.254	.222	.850	.953	.028	
MS20663-C6		3/16	.025	.487	.442	.293	.255	1.012	1.140	.033	
MS20663-C7		7/32	.032	.555	.505	.347	.302	1.175	1.328	.038	
MS20663-C8		1/4	.040	.624	.567	.401	.348	1.337	1.515	.042	
MS20663-C9		9/32	.042	.694	.632	.439	.382	1.497	1.719	.046	
MS20663-C10		5/16	.043	.763	.694	.475	.413	1.664	1.880	.046	

Not intended for overhead lifting

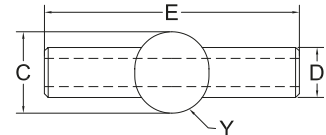

Stamped Eyelets (Stainless Steel or Zinc Plated)

Code		For Cable Diameter in.	Material Type	Weight approx. per 100 Pcs. lbs.	Dimensions in.				
Ben-Mor	Continental				A	C	G	T	X
BMSEZ-364A	2083-01.5	3/64	Z.P.	.38	.315	.320	.160	.060	.715
BMSES-364A	2081-01.5	3/64	S.S.	.38	.315	.320	.160	.060	.715
BMSEZ-364B	2023-01.5	3/64	Z.P.	.35	.315	.320	.190	.060	.715
BMSES-364C	2023-01.5	3/64	S.S.	.33	.315	.320	.190	.050	.715
BMSEZ-364B	2021-01.5	3/64	S.S.	.35	.315	.320	.190	.060	.715
n/a	2093-02*	1/16	Z.P.	.25	.340	.380	.129	.035	.650
n/a	2091-02*	1/16	S.S.	.25	.340	.380	.129	.035	.650
n/a	2103-02*	1/16	Z.P.	.24	.340	.380	.194	.035	.650
n/a	2101-02*	1/16	S.S.	.24	.340	.380	.194	.035	.650
BMSEZ-116C	2313-02	1/16	Z.P.	.74	.400	.460	.129	.060	.978
BMSEZ-116D	2003-02	1/16	Z.P.	.69	.320	.430	.190	.060	.940
BMSES-116D	2001-02	1/16	S.S.	.69	.320	.430	.190	.060	.940
BMSEZ-116E	2013-02	1/16	Z.P.	.63	.320	.430	.260	.060	.940
BMSES-116E	2011-02	1/16	S.S.	.63	.320	.430	.260	.060	.940
BMSEZ-116F	2173-02	1/16	Z.P.	.65	.400	.460	.204	.060	.978
BMSES-116F	2171-02	1/16	S.S.	.65	.400	.460	.204	.060	.978
BMSEZ-332A	2303-03	3/32	Z.P.	1.92	.470	.500	.205	.093	1.42
BMSES-332A	2301-03	3/32	S.S.	1.92	.470	.500	.205	.093	1.42
BMSEZ-332B	2343-03	3/32	Z.P.	1.88	.470	.500	.250	.093	1.42
BMSES-332B	2341-03	3/32	S.S.	1.88	.470	.500	.250	.093	1.42
BMSEZ-332C	2323-03	3/32	Z.P.	2.04	.450	.750	.375	.093	1.31
BMSES-332C	2321-03	3/32	S.S.	2.04	.450	.750	.375	.093	1.31
BMSEZ-332D	2333-03	3/32	Z.P.	1.81	.450	.750	.500	.093	1.31
BMSES-332D	2331-03	3/32	S.S.	1.81	.450	.750	.500	.093	1.31
BMSEZ-018A	2403-04**	1/8	Z.P.	4.66	.480	.580	.250	.125	1.95
BMSES-018A	2401-04**	1/8	S.S.	4.66	.480	.580	.250	.125	1.95
BMSEZ-018B	2413-04**	1/8	Z.P.	4.64	.480	.580	.316	.125	1.95
BMSES-018B	2411-04**	1/8	S.S.	4.64	.480	.580	.316	.125	1.95
BMSEZ-018C	2423-04	1/8	Z.P.	4.92	.540	.850	.375	.125	1.84
BMSES-018C	2421-04	1/8	S.S.	4.92	.540	.850	.375	.125	1.84
BMSEZ-018D	2433-04	1/8	Z.P.	4.56	.540	.850	.500	.125	1.84
BMSES-018D	2431-04	1/8	S.S.	4.56	.540	.850	.500	.125	1.84

Not intended for overhead lifting

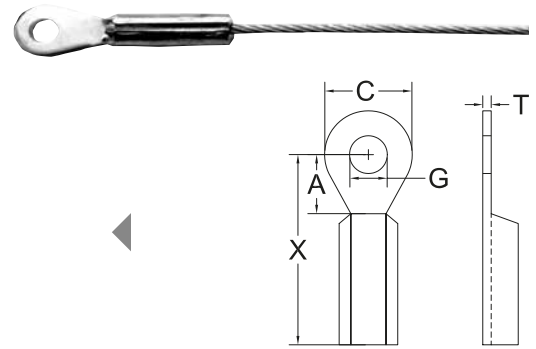

Before swage

Eyelet part #2303-03 swaged with a 50 Ton Hydraulic swager onto 3/32" 7 x 7 cable. *2093-02, 2091-02, 2103-02, & 2101-02 holds 250 lbs. max. without distortion to eyelet.

**2403-04, 2401-04, 2413-04, & 2411-04 holds 1600 lbs. max.

General Notes:

Stamped eyelets must be assembled with a mechanical or hydraulic swager using properly designed dies. A pull test should be performed to determine the holding strength of the applied eye, and suitability for your application.

Stainless Straps Eye with markings

Code	Diameter in.	Dimensions in.				
		C	D	J	L	T
NAS1435-E2	1/16	.454	.188	.088	1 1/16	.042
NAS1435-E3	3/32	.616	.188	.103	1 1/2	.049
NAS1435-E4	1/8	.638	.188	.190	1 5/8	.093
NAS1435-E5	5/32	.699	.250	.197	1 15/16	.096
NAS1435-E6	3/16	.750	.313	.255	2 3/16	.125

Not intended for overhead lifting

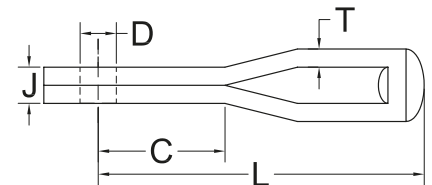

Stainless Straps Fork with markings

Code	Diameter in.	Dimensions in.				
		C	D	G	L	T
NAS1435-K2	1/16	.454	.188	.093	1 1/16	.042
NAS1435-K3	3/32	.616	.188	.108	1 1/2	.049
NAS1435-K4	1/8	.638	.188	.195	1 5/8	.093
NAS1435-K5	5/32	.699	.250	.202	1 15/16	.096
NAS1435-K6	3/16	.750	.313	.260	2 3/16	.125

Not intended for overhead lifting

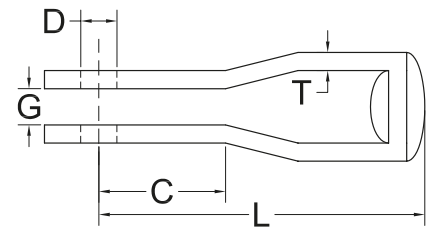



Marketing

Call your representative for assistance in configuring your own inhouse display.

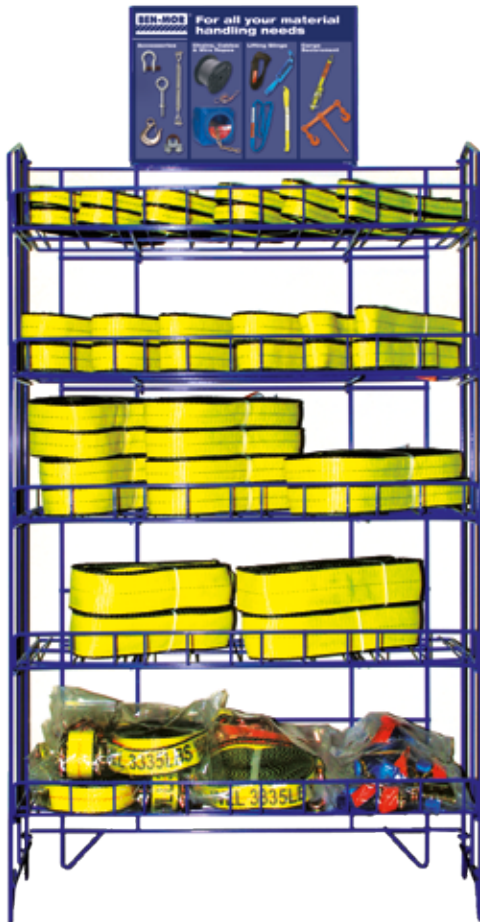

Merchandising At Its Best !



Conversion Table

Fractions	Decimals	mm	Fractions	Decimals	mm
1/64"	0.015625	0.3969	33/64"	0.515625	13.0969
1/32"	0.03125	0.7938	17/32"	0.53125	13.4938
3/64"	0.046875	1.1906	35/64"	0.546875	13.8906
1/16"	0.0625	1.5875	9/16"	0.5625	14.2875
5/64"	0.078125	1.9844	37/64"	0.578125	14.6844
3/32"	0.09375	2.3812	19/32"	0.59375	15.0812
7/64"	0.109375	2.7781	39/64"	0.609375	15.4781
1/8"	0.125	3.175	5/8"	0.625	15.875
9/64"	0.140625	3.5719	41/64"	0.640625	16.2719
5/32"	0.15625	3.9688	21/32"	0.65625	16.6688
11/64"	0.171875	4.3656	43/64"	0.671875	17.0656
3/16"	0.1875	4.7625	11/16"	0.6875	17.4625
13/64"	0.203125	5.1594	45/64"	0.703125	17.8594
7/32"	0.21875	5.5562	23/32"	0.71875	18.2562
15/64"	0.234375	5.9531	47/64"	0.734375	18.6531
1/4"	0.25	6.35	3/4"	0.75	19.05
17/64"	0.265625	6.7469	49/64"	0.765625	19.4469
9/32"	0.28125	7.1433	25/32"	0.78125	19.8438
19/64"	0.296875	7.5406	51/64"	0.796875	20.2406
5/16"	0.3125	7.9375	13/16"	0.8125	20.6375
21/64"	0.328125	8.3344	53/64"	0.828125	21.0344
11/32"	0.34375	8.7312	27/32"	0.84375	21.4312
23/64"	0.359375	9.1281	55/64"	0.859375	21.8281
3/8"	0.375	9.525	7/8"	0.875	22.225
25/64"	0.390625	9.9219	57/64"	0.890625	22.6219
13/32"	0.40625	10.3188	29/32"	0.90625	23.0188
27/64"	0.421875	10.7156	59/64"	0.921875	23.4156
7/16"	0.4375	11.1125	15/16"	0.9375	23.8125
29/64"	0.453125	11.5094	61/64"	0.953125	24.2094
15/32"	0.46875	11.9062	31/32"	0.96875	24.6062
31/64"	0.484375	12.3031	63/64"	0.984375	25.0031
1/2"	0.5	12.7	1"	1.0	25.4

Pulley or Sheave Diameter According To Cable Construction

Construction	Sheave Diameter	
	Recommended	Minimum
6 x 19	45 x d	34 x d
6 x 36	35 x d	23 x d
19 x 7	51 x d	34 x d
7 x 7 GAC	72 x d	42 x d
7 x 19 GAC	35 x d	26 x d
7 x 7 SS	82 x d	65 x d
7 x 19 SS	40 x d	31 x d

d = wire rope diameter

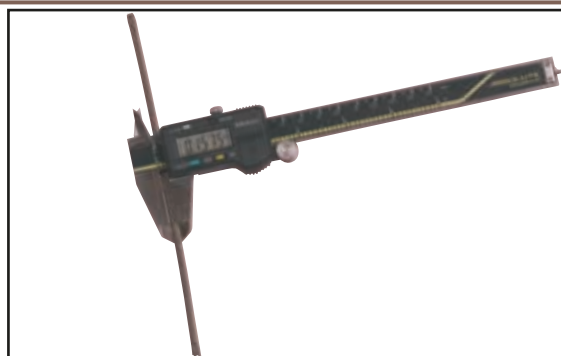

General Sales Conditions

Guarantee

All "Ben-Mor inc." products are unconditionally guaranteed against manufacturing defects. Any item found to be defective will be replaced or adjusted, provided "Ben-Mor inc." is notified promptly upon receipt of merchandise. "Ben-Mor inc." reserves the right to request that the defective item be returned for examination purposes. The purchaser will be responsible for labor charges incurred by the examination of the returned item(s). "Ben-Mor inc." liability regarding defects in any item shall be limited to its replacement or to the adjustment for an amount equal to the price paid for the item. Debit memos will not be accepted without prior written authorization by "Ben-Mor inc."

Claims for loss or damage in transit

All products are carefully inspected and packaged to assure delivery in good condition. Product damage or loss occurring in transit is the responsibility of the carrier, and in the event of such loss, the purchaser must advise the carrier within 10 days after delivery. "Ben-Mor inc." will give all reasonable assistance in tracing shortages and filing claims.

Returned Merchandise

Credit will not be issued for material returned without written authorization from "Ben-Mor inc." Return request must be mailed to the "Ben-Mor inc." office and must include an itemized list of materials with the dates and numbers of invoices. All returns must be done within thirty days of delivery of goods. Items are subject to 20% handling charge.

No returns of manufactured goods (assemblies, custom cuts, fabrications of any kind, etc.) or items sourced by special orders will be accepted.

Prices

All prices are subject to change without notice. Invoices will be based on the prices prevailing at date of shipment. Because of the unpredictable fluctuations of raw materials, "Ben-Mor inc." may be forced to add surcharges without notice, and due to rapid changes, these surcharges may result in immediate additional costs to our customers. When possible, "Ben-Mor inc." will advise of surcharges in advance.

Payment Terms

Net 30 days. Service charge of 2% per month will apply against all outstanding balances over 30 days, or 24% annually.

Crédit

Open account terms will be extended to firms with satisfactory commercial credit rating. Firms without satisfactory commercial credit rating may qualify for open account terms, by listing on their order form the name of their bank and three active credit references. When we lack proper credit information, in order to avoid delay in servicing an order, we will ship "cash on delivery" payment basis (C.O.D.).

Specifications

The dimensions, weights, strengths, lengths, and other specifications shown in the catalog are subject to variation within reasonable tolerances.



Index

Anchor Point	86	Fork	33, 139	Strap Fork	33, 139
Armored Cable	13	Hammerlock Type		Stub End Turnbuckles	26
Ball Fitting	138	Connecting Links	65, 69	Studs	33
Beams	109	Hoist & Trolleys	108	Swage Cable	13, 123
Bracing Cable	131	Hoist Rings	85-87	Swage Sockets	31
Buttons	18, 123	Hooks		Swagers	110-111
Cables Roll Off	119	Grade 40	27	Sway Bracing Cable With Straight Eyelet	129
Cable & Wire Rope	10-15	Grade 70	118	Sway Bracing Cable With 45° Eyelet	129
Chain		Grade 80	68-69	Swivels	23, 32
Grade 30	101	Grade 100	64-65	Synthetic Slings	38-46
Grade 40	100	Stainless Steel	37	Tagline	70-71
Grade 70	116	Others	26-28, 90-91, 104, 120-121	Thimbles	19, 34
Grade 80	66	Jaw and Swage Terminal	31, 36	Threaded Fittings	134
Grade 100	62	Jaw Fitting	137	Tie-Down Accessories	120-121
Stainless Steel	100	Kwik-Locs	131	Tie Down, Cable and Chain	116-117
Agricultural Safety Chain	117	Lap Links	105	Toggle Block	29, 82, 83
Bead & Connectors	105	Latch	28	Tow Cables	126
Cathedral	104	Lifting Eye Bolt	35	Tow Chain	116-117
Coil	102	Lifting Point	87	Tow Slings	45
Craft	105	Load Binders	115	Trailer Safety Chain	126
Cutter	111	Load Binder Locks	115	Triangles	42
Decorative Oval Chain	104	Looped Cable	131	Turnbuckles	24-26, 36
Double Loop	103	Main Lines	122	Wear Pads	41, 48
Electrical	104	Marine Eyes	36	Web Slings	38-46
Furnace	103	Marine Slings	44	Web Sling Connectors	64
Harrow	102	Master Oblong Links	63, 67, 72, 79	Welded Master Link Assembly	67
Hobby	105	Master Rings	67	Wire Rope & Cable	10-15
Jack	103	Mil Spec Cable	135	Wire Rope Clips	20, 89
Logging	122	Military Fittings	136-139	Wire Rope Cutters	111
Lock Link	103	Pear Shape Weldless Links	67	Wire Rope Slings	57-59
Machine	102	Plate Clamp	109	Whip Restraints	127
Passing Link	102	Pulleys	29, 82, 83	Winch Cables	126
Plastic	104	Quick Links	32, 37		
Safety	104	RFID	95		
Sash	104	Replacement Links	105		
Sling	60	Rings for Main-lines	123		
Tie Down	116-117	Rope	106-107		
Tow	117	Round Rings	32		
Utility	102	Round Slings	48-56		
Vinyl covered	103	"S" Hooks	37, 104, 114		
Cable Clamps	89	Shackles	20-21, 37, 76, 88		
Chokers	122	Shank Balls	138		
Coated Cable	16-17	Sheaves	82-83		
Cold Shuts	105	Sleeves	18, 34		
Concrete Anchors	127	Slings			
Coupling	70	Chain Slings	60-61		
Cutters	110-111	Round Slings	48-56		
Double Clevis Chain Midlink	118	Web Slings	38-46		
Drum Slings	44	Wheel Lift Strap	44		
Eyelets	131, 139	Wheel Net	44		
Eye Bolts	22-23, 35	Wire Rope Slings	58-59		
Eye End	33	Snaps	32, 36, 37		
Eye Fitting	137	Snatch Block	29		
Eye Nuts	23, 35	Sockets	30-31		
Forestry Chokers	122	Strap Eyes	139		





info@ben-mor.com
www.ben-mor.com

Head Office

1105, Lemire, St-Hyacinthe, Quebec,
Canada, J2T 1L8
☎ 1-800-481-0022 • 450-778-0022

Barrie, Ontario

690, Bayview Dr, Barrie, Ontario,
Canada, L4N 9A6
☎ 1-800-423-4423

Calgary, Alberta

Unit #108 10725 25 Street NE, Calgary, Alberta,
Canada, T3N 0A4
☎ 403-279-9631

Distribution Center

Retail products
1400, Nobel, Boucherville, Québec,
Canada, J4B 5H3



Hinsdale, New Hampshire

253 Monument Road, Hinsdale,
New Hampshire, 03451, USA
☎ 1 800 229-5131
www.continentalcablellc.com

Winnipeg, Manitoba

21 Sylvan Way, Winnipeg,
Manitoba, R2R 2B9
☎ 204-633-1529 • 1-800-689-8744

Saskatoon, Saskatchewan

118 Faithfull Crescent, Saskatoon,
Saskatchewan, S7K 8H8
☎ 306-651-1834



Bristol, Rhode Island

67 Ballou Blvd., Bristol, RI 02809, USA
☎ 401-253-1344

Bensenville, Illinois

700 County Line Rd, Bensenville,
IL 60106, USA
☎ 630-787-9715

Jacksonville, Florida

351 Zoo Pkwy, Jacksonville,
FL 32226, USA
☎ 904-751-1441

www.fortunerope.com

